

Validation of EIC IR Magnet Parameters and Requirements Using Existing Magnet Results

Tim Michalski (PI)

With contributions from:

Chuck Hutton, Fanglei Lin, Vasily Morozov,
Renuka Rajput-Ghoshal, Mark Wiseman
(JLAB)

GianLuca Sabbi (Co-PI) – (LBNL)

Michael Sullivan (Co-PI), Yuri Nosochkov
(SLAC)

Jefferson Lab

2019 NP Accelerator R&D PI Exchange Meeting
November 7, 2019, Gaithersburg, MD

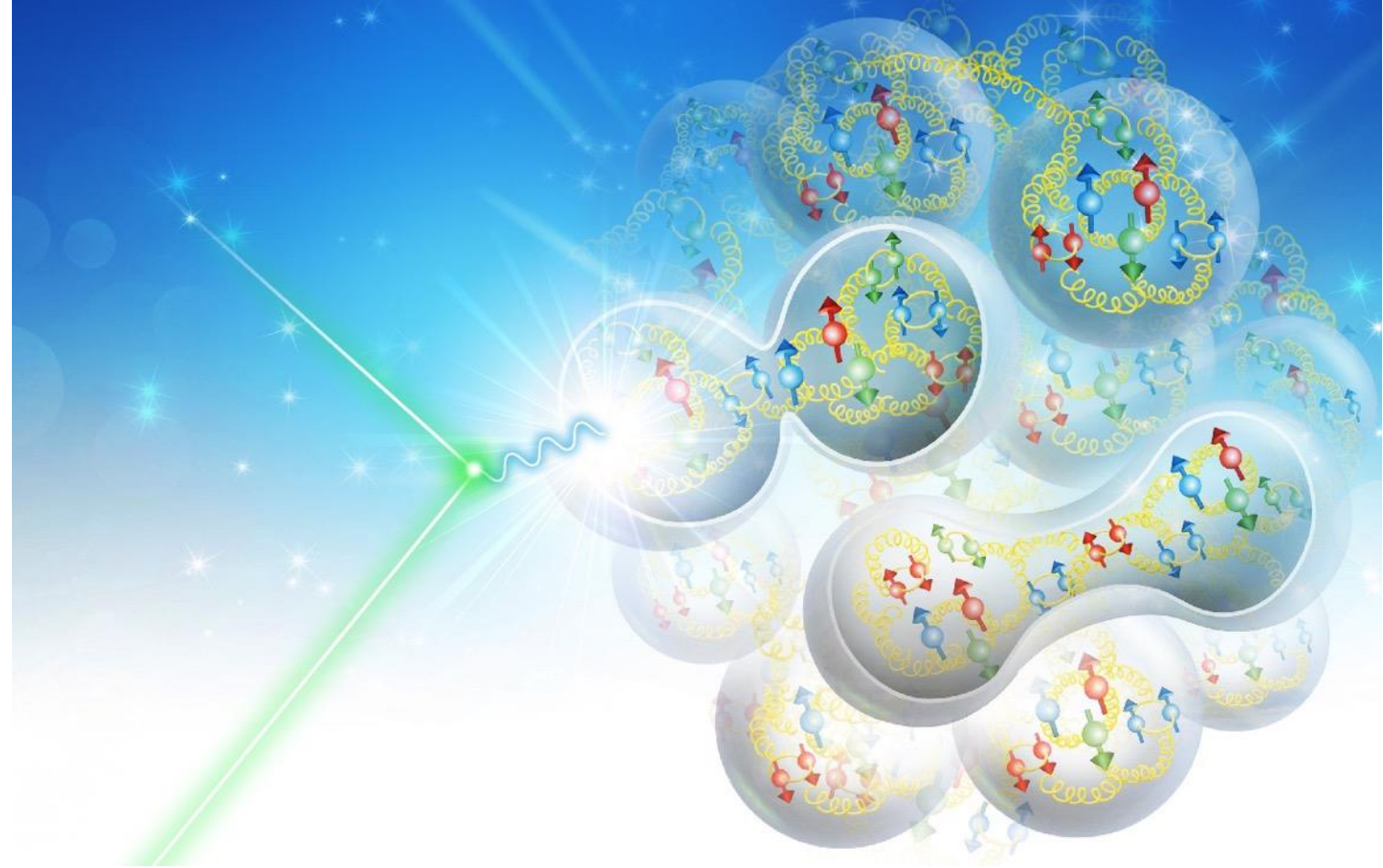

Description of the project

- The main goal of the project:
 - It is very important to understand the alignment and multipole requirements of the FFQs and to design an orbit correction scheme and a multipole compensation system, as proposed in this project.
- Jones Report Priority Alignment:

Row No.	Proponent	Concept / Proponent Identifier	Title of R&D Element	Panel Priority	Panel Sub-Priority
4	PANEL	ALL	Benchmarking of realistic EIC simulation tools against available data	High	A
5	PANEL	ALL	Validation of magnet designs associated with high-acceptance interaction points by prototyping	High	A

- The main alignment is Row 5.
- Since we propose to compare our simulation results to existing data, our proposal also meets the High-A priority item in row 4 of the panel's priority table: Benchmarking of realistic EIC simulation tools against available data.

Annual Budget and the Total Received to Date

The award for the JLab (TJNAF) portion is part of the Lab Base R&D (redirect).

	FY'18-FY'19 (YEAR 1)	FY'19-FY'20 (YEAR 2)	Total
a) Funds allocated	\$610,000	\$610,000	\$1,220,000
b) Actual costs to date	\$605,650	\$54,130	\$659,780

Major Deliverables and Schedule

- **Milestones reached by**

- **6 months after the start of funding**

- Interaction Region (IR) orbit correction and alignment tolerances
- Synchrotron Radiation (SR) heat loads and shielding

- **12 months after the start of funding**

- Performance with existing magnet data
- SR heat loads and shielding

- **18 months after the start of funding**

- Design and simulation of multipole correction
- SR heat loads and shielding

- **24 months after the start of funding**

- Multipole tolerances and corrector specifications
- SR heat loads and shielding
- Layout of JLEIC IR

Task	YR 1 Q1	YR 1 Q2	YR 1 Q3	YR 1 Q4	YR 2 Q1	YR 2 Q2	YR 2 Q3	YR 2 Q4
IR orbit correction	✓	✓						
IR with existing magnet data			✓	✓				
IR multipole correction				✓	X	X	X	X
SR heat loads and shielding	✓	✓	✓	✓	X	X	X	X
Feedback on magnet requirements from the accelerator physics team	✓	✓						
Assess magnet space requirements to ensure a realistic IR layout		✓	✓					
Formulate field error tables based on LARP experience			✓	✓				
Explore and select from alternative magnet and structure options	✓	✓	✓	✓				
Mechanical and magnetic analysis of proposed design					X	X	X	X
Incorporate experience from BNL model design, fabrication, and test					X	X	X	X
Update IR layouts based on results of project						X	X	X

Current Status

- 2 changes were implemented on the JLEIC IR magnets at the start of this R&D project:
 - All IR magnets designs were updated to use NbTi conductor, no Nb₃Sn
 - The IR was updated to support 200 GeV ions
- All Year 1 planned activities have been achieved. Some will be iterated on as further definition of multipole tuning and correction schemes evolve.
- Updated lattice files to compensate for:
 - Coupling and chromaticity compensation, betatron tunes, phase advance in the ICR
 - Off angle kick to ion beam from detector solenoid
 - Compensation for effects of the detector solenoid on ECR and ICR by addition of anti-solenoids
- Multipole errors from 4 sources have been scaled and applied to the IR final focus quadrupoles (FFQ):
 - HL-LHC FFQs
 - PEP-II FFQs
 - SuperKEKB FFQs
 - TOSCA modeling of JLEIC ECR FFQs
- Random and systematic errors have been introduced in order to assess the impact on dynamic apertures (DA) of the electron collider ring (ECR) and ion collider ring (ICR).

Electron IR Optics

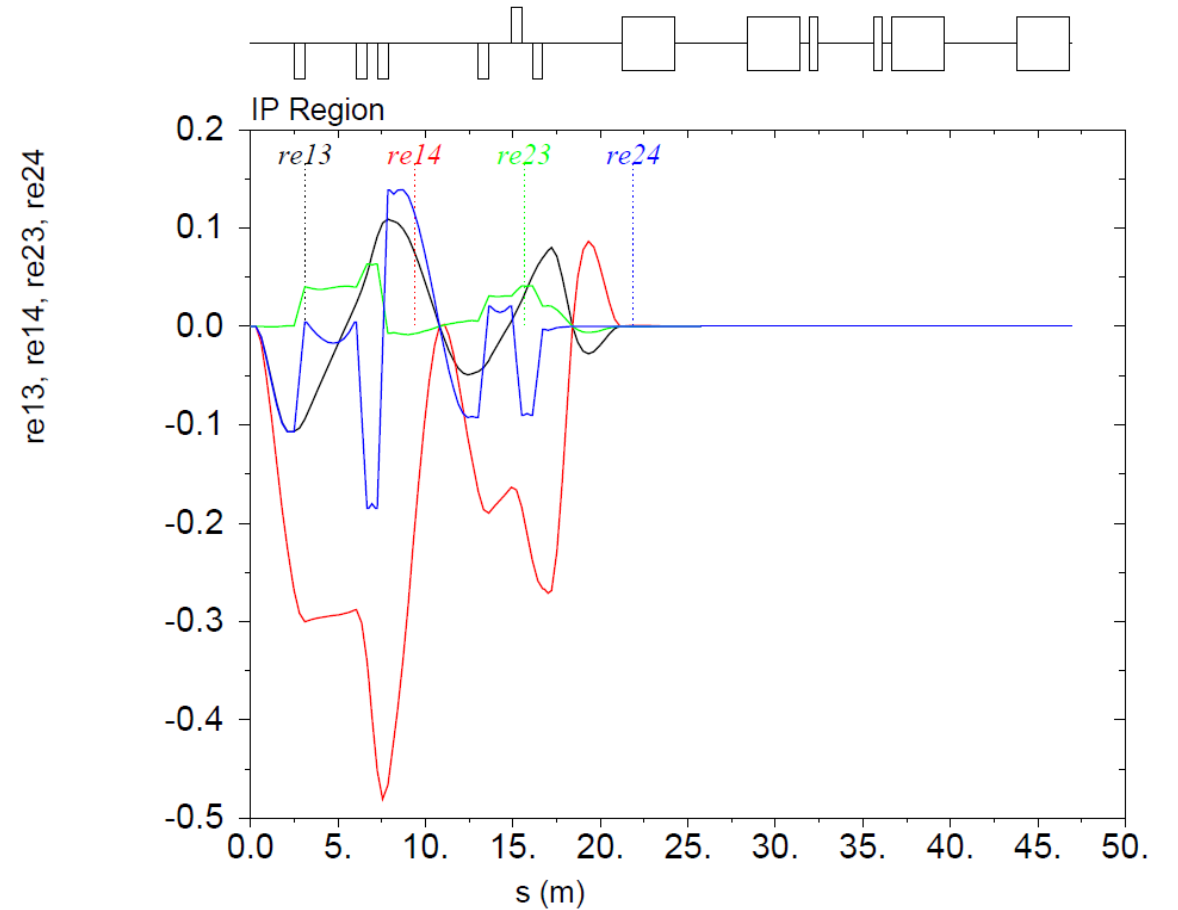
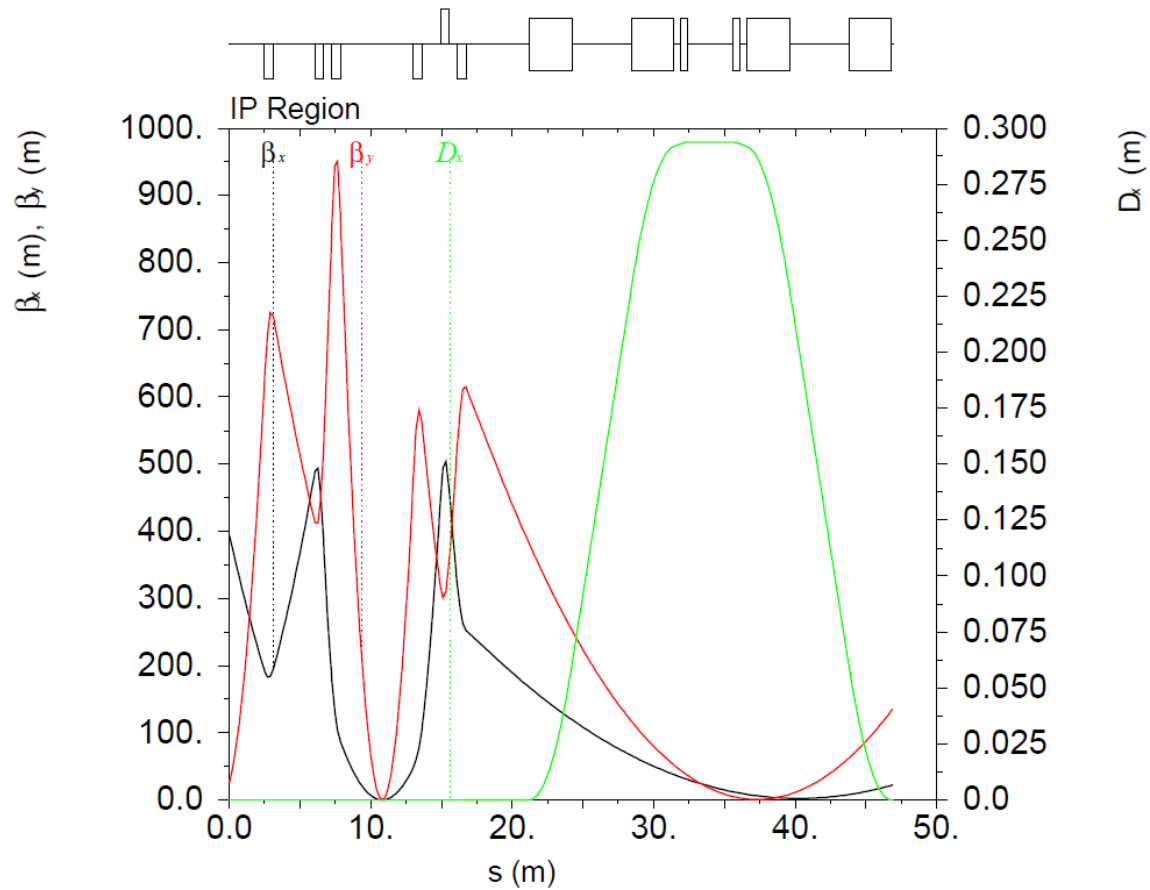

Electron DA with misalignment, strength errors and multipoles

- Electron ring tracking using LEGO
- 10 seeds of misalignment, strength errors, and multipole errors in all magnets
- Case 1: PEP-II HER measured multipoles in all magnets (dipoles, quads, sextupoles)
- Case 2: HL-LHC IT specified multipoles in FFQ, PEP-II multipoles in all other magnets
- Case 3: SuperKEKB specified multipoles in FFQ, PEP-II multipoles in all other magnets

PEP-II multipoles in FFQ
DA $x/y = 9.4 / 40.6 \sigma$

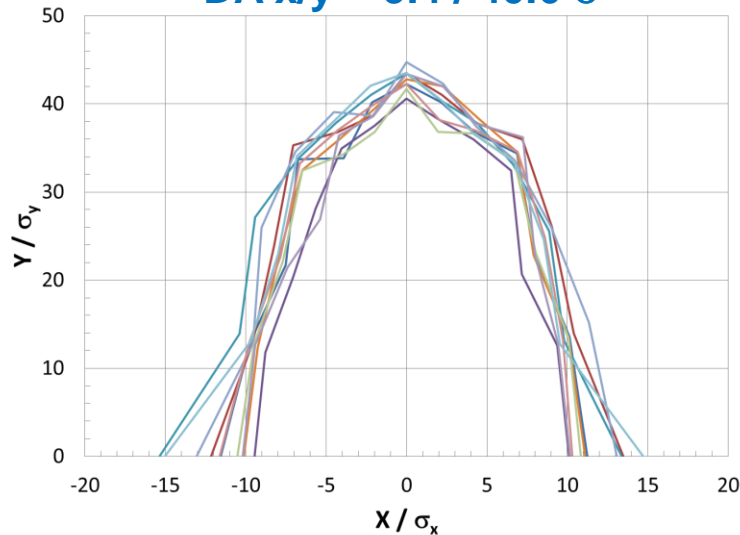

HL-LHC IT multipoles in FFQ
DA $x/y = 11.3 / 42.6 \sigma$

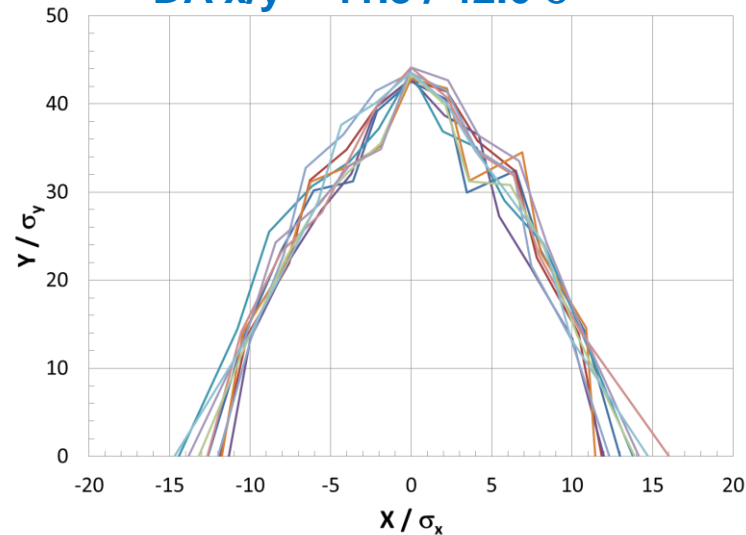

SuperKEKB multipoles in FFQ
DA $x/y = 13 / 40 \sigma$

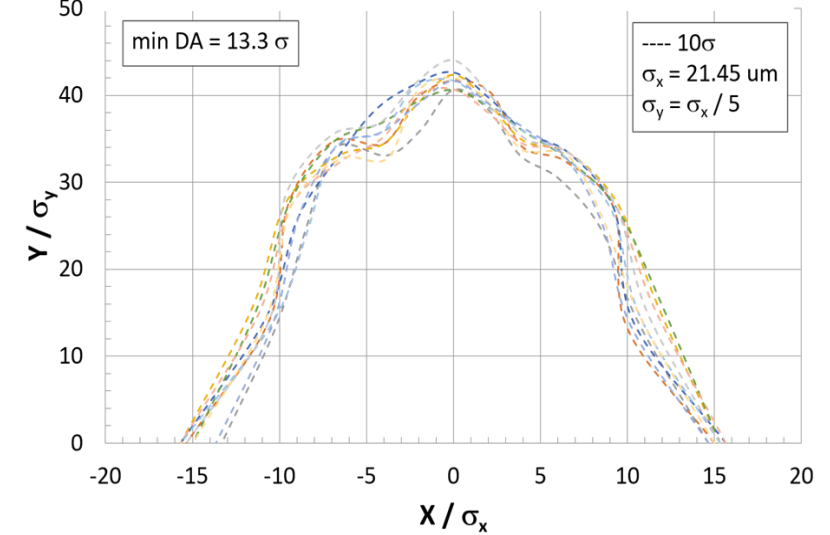

Ion IR Optics

Orbit correction

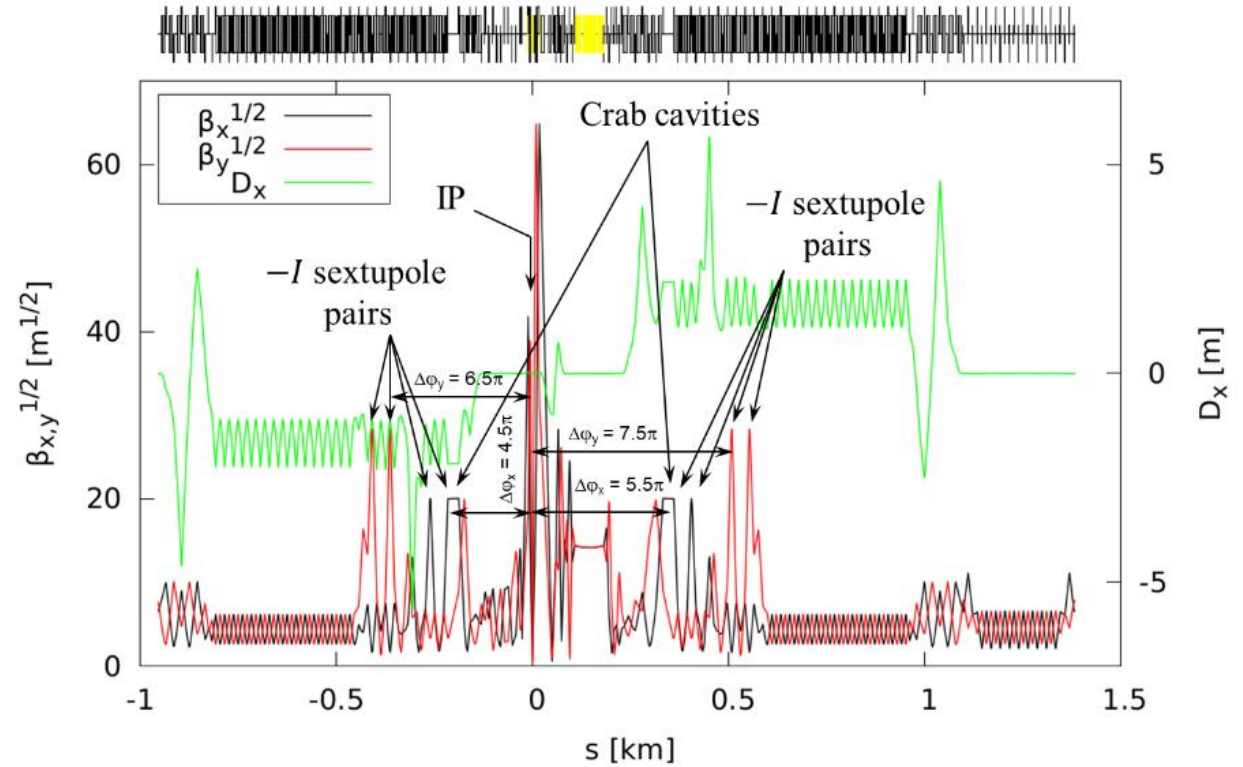
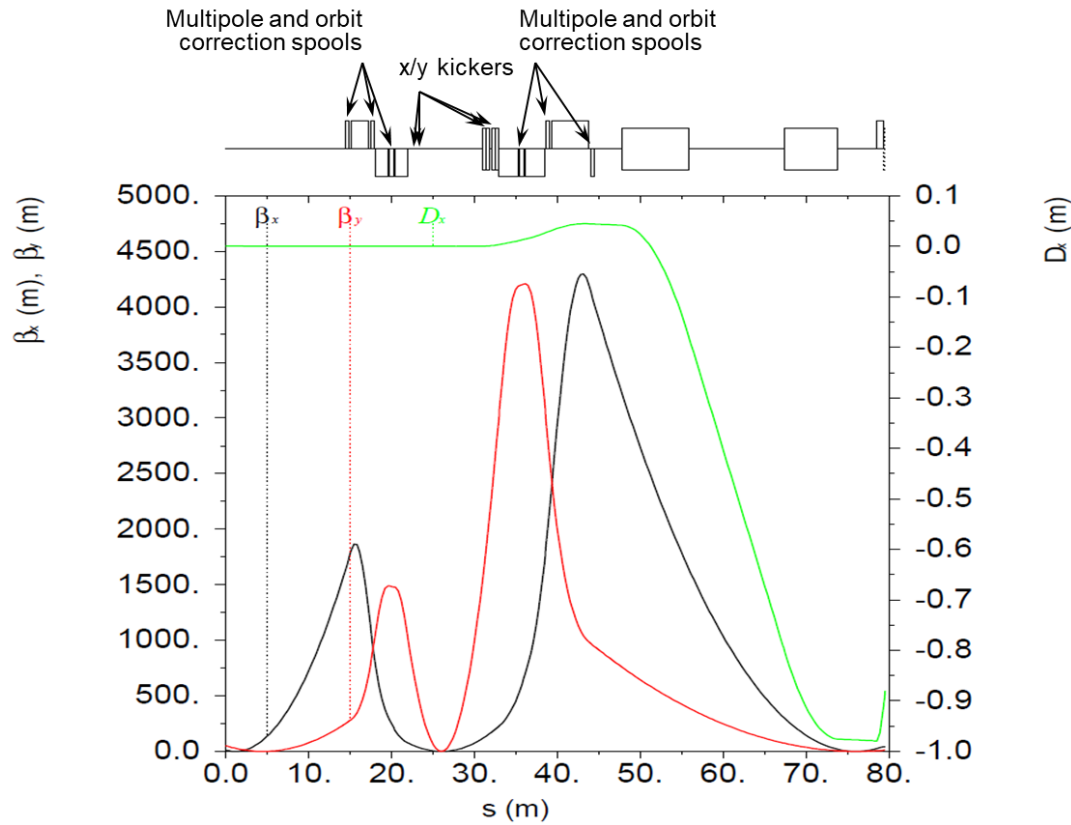

Ion Dynamic Aperture

Bare Lattice ($\pm 60\sigma$)

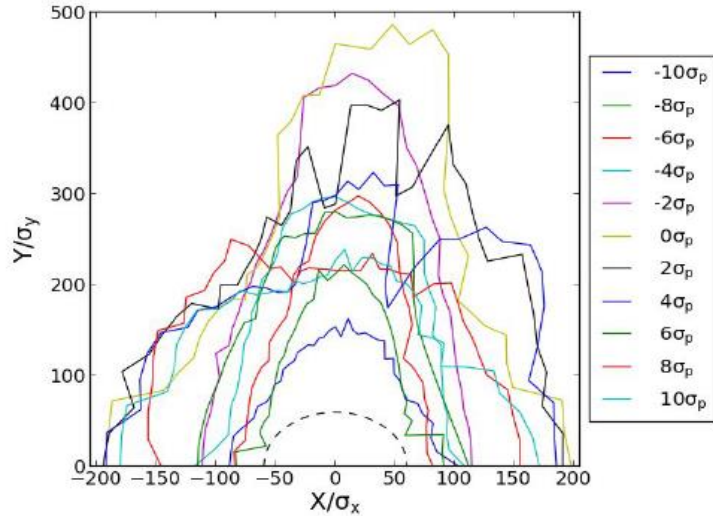

Figure 1

SuperKEKB ($\pm 12.7\sigma$)

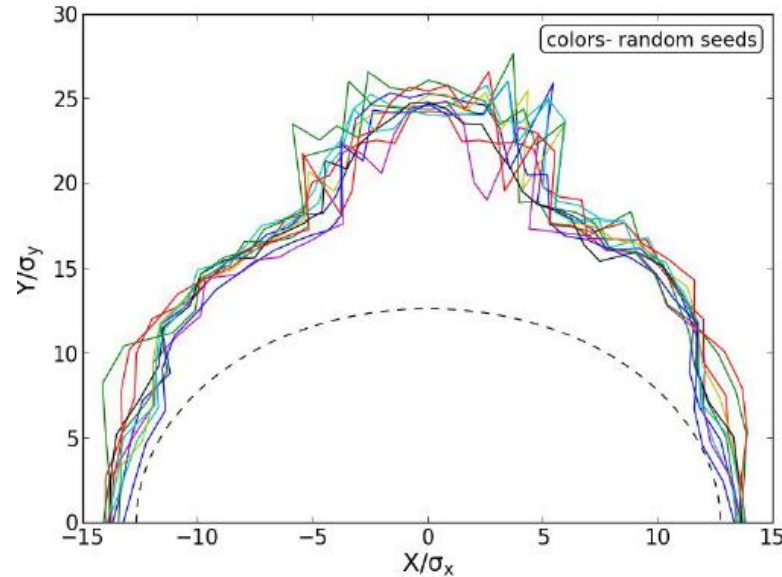

Figure 2

JLEIC Electron Quad Model ($\pm 10\sigma$)

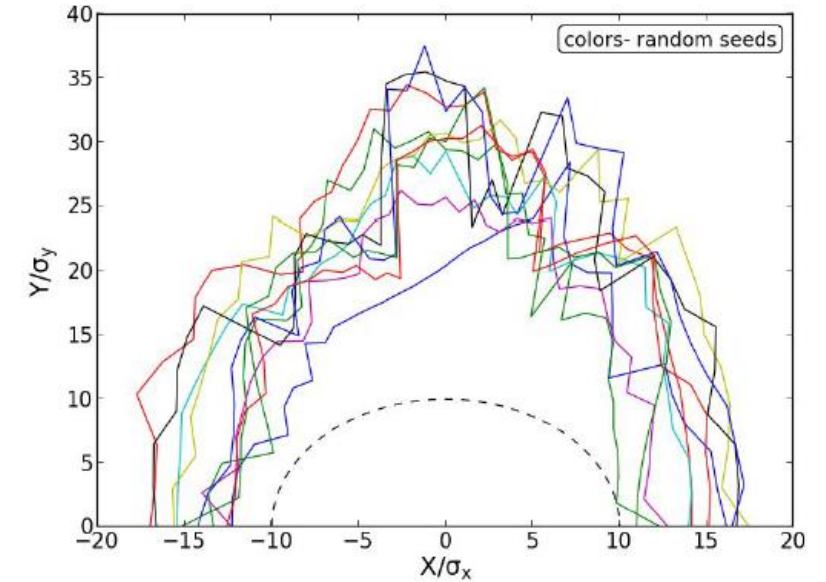

Figure 3

- Bare lattice DA for different momentum offsets (Fig. 1)
- DA for on momentum particles within 10 random seeds for multipole errors
- Multipoles were introduced to all 6 IR quads
- For JLEIC electron quads, $b_6=3.97$ and $b_{10}=0.09$

n	Avg.		rms	
	a_n	b_n	a_n	b_n
3	0.84	0.42	2.27	2.03
4	0.43	-0.22	1.36	0.68
5	-0.38	-0.18	0.84	0.91
6	-0.18	4.44	1.36	3.49
7	0.27	-0.04	0.24	0.39
8	0.04	-0.41	0.72	0.35
9	0.48	1.48	1.8	2.88
10	-0.55	-7.2	1.28	3.66

JLEIC Interaction Region

- The electron and ion rings intersect at the interaction point (IP) and the region around IP is called interaction region (IR).
- Crossing angle is 50 mrad
- The IR contains a full acceptance detector built around a detector solenoid.
- Forward Side ion magnets have apertures which support ± 10 mrad angular acceptance

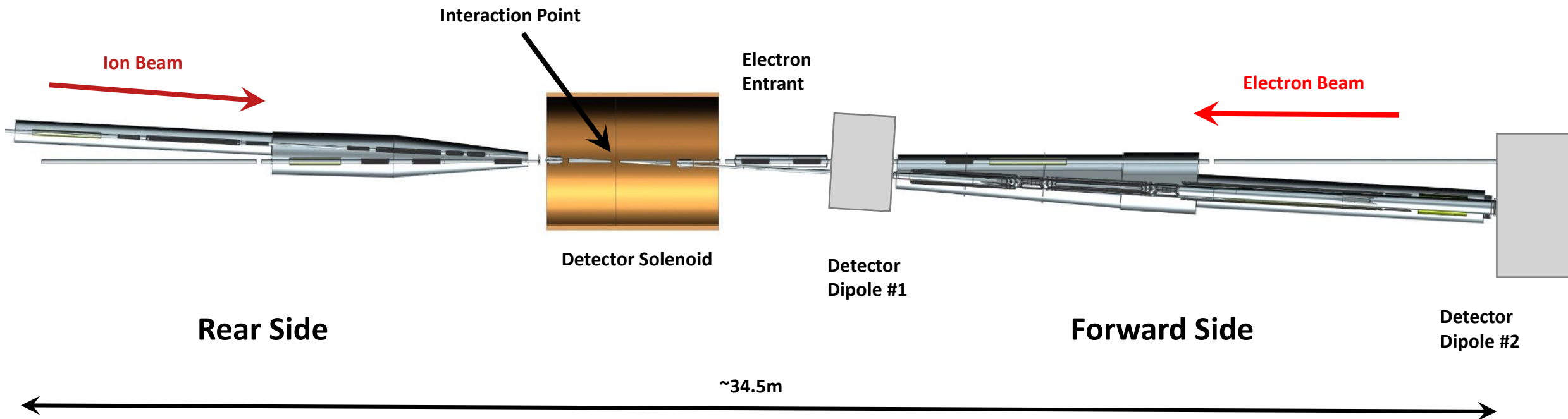

IR Magnet Specifications and Design Parameters

- All final focus quadrupole magnets use NbTi conductor
- Operating temperature between 4.5 K and 4.7 K
- All IR magnets are designed as cold bore, to lower the peak field in the coils

Element Name	Type	Specifications								Design				
		Length [m]	Good Field Radius [cm]	Aperture Inner Radius [cm]	Outer Radius [cm]	Dipole field [T]		Quadrupole field [T/m]		Solenoid [T]	Coil Inner Radius [cm]	Coil Outer Radius [cm]	Coil Width in Radial Direction [mm]	Peak Field in the coil [T]
						Bx	By	Normal	Skew					
Ion Rear Side Elements														
iASUS	SOLENOID	1.6	3.0	4.0	12.0	0	0	0	0	2	6	6.7	7	2.0
iQUS3S	QUADRUPOLE	0.5	3.0	4.0	12.0	0	0	0	3.38	0	4.5	4.7	2	0.3
iQUS2	QUADRUPOLE	2.1	3.0	4.0	12.0	0	0	94.07	0	0	4.5	7.8	33	5.7
iQUS2S	QUADRUPOLE	0.5	2.0	3.0	10.0	0	0	0	-9.26	0	3.5	4	5	0.6
iQUS1b	QUADRUPOLE	1.45	2.0	3.0	10.0	0	0	-97.88	0	0	3.45	4.95	15	5.1
iQUS1S	QUADRUPOLE	0.5	2.0	3.0	10.0	0	0	0	16.42	0	3.5	4.4	9	0.9
iQUS1a	QUADRUPOLE	1.45	2.0	3.0	10.0	0	0	-97.88	-3.08	0	3.45	5.75	23	5.1
iCUS1	KICKER	0.3	2.0	3.0	10.0	-3.90	0.076	0	0	0	3.45	5.25	18	6.3
iCUS2	KICKER	0.3	2.0	3.0	10.0	4.50	-0.019	0	0	0				
Ion Forward Side Elements														
iQDS1a	QUADRUPOLE	2.25	4.0	9.2	23.1	0.0	0	-37.23	-1.23	0	13.0	17.1	41	6.4
iQDS1S	QUADRUPOLE	0.5	4.0	9.9	24.8	0.0	0	0	14.85	0	13.0	14.2	12	3.9
iQDS1b	QUADRUPOLE	2.25	4.0	12.3	31.0	0.0	0	-37.23	0	0	13.0	16.3	33	6.4
iQDS2S	QUADRUPOLE	0.5	4.0	13.0	32.7	0.0	0	0	-7.83	0	13.6	14.5	9	2.3
iQDS2	QUADRUPOLE	4.5	4.0	17.7	44.4	0.0	0	25.96	0	0	18.2	21.5	33	7.0
iQDS3S	QUADRUPOLE	0.5	4.0	18.4	46.2	0.0	0	0	0.63	0	20.0	20.2	2	0.4
iASDS	SOLENOID	1.2	4.0	19.8	49.7	0.0	0	0	0	4	22.5	24.0	15	4.0
Electron Rear Side Elements														
eASDS	SOLENOID	1.2	2.2	4.5	11.0	0	0	0	0	-4	4.95	6.5	15.5	3.6
eQDS3	QUADRUPOLE	0.6	2.4	4.5	10.0	0	0	-18.72	-2.71	0				
eQDS2	QUADRUPOLE	0.6	2.8	4.5	8.5	0	0	36.22	5.25	0				
eQDS1	QUADRUPOLE	0.6	1.7	4.5	8.0	0	0	-33.75	-4.89	0				
Electron Forward Side Elements														
eQUS1	QUADRUPOLE	0.6	2.0	4.5	10.0	0.0	0.00	-36.94	8.10	0	4.95	6.5	15.5	3.6
eQUS2	QUADRUPOLE	0.6	3.2	4.5	11.0	0.0	0.00	33.66	-7.38	0				
eQUS3	QUADRUPOLE	0.6	1.5	4.5	11.0	0.0	0	-20.80	4.56	0				
eASUS	SOLENOID	1.8	2.2	4.5	11.0	0.0	0	0	0	-4				

Very Large Aperture NbTi Quadrupoles – Reference Designs

Magnet	Gradient (T/m)	Bore ID (m)	FoD* – G^2R^3 (T/m) ² m ³
RHIC IRQ	48	0.13	5.1
eRHIC Q1ApF	72.6	0.112	7.4
JLEIC iQDS1a	37.2	0.184	8.6
CERN ISR	40	0.20	12.8
JLAB Hall C, Q3	7.9	0.6	13.5
AHF Case II	10.3	0.51	14.1
eRHIC Q1BpF	66.2	0.156	16.6
JLEIC iQDS1b	37.2	0.246	20.6
eRHIC Q2pF	40.7	0.262	29.8
JLEIC iQDS2	26	0.354	30
JLAB Hall C, Q2	11.8	0.6	30.1
HIF RPD FFQ	24.2	0.51	77.7

(* Ref: J. Waynert et al, IEEE Trans. Appl. Supercond. Vol. 11, March 2001, pp. 1522

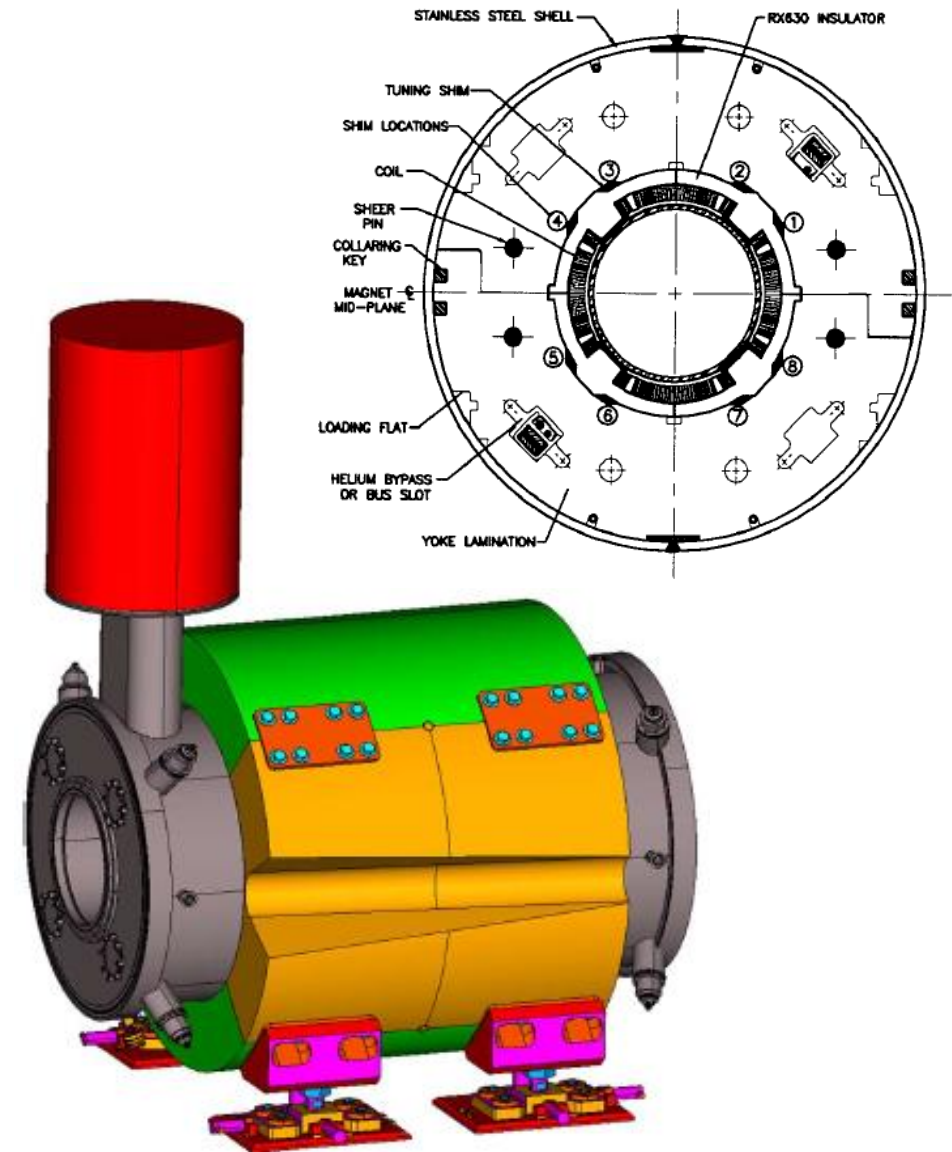

Ion Quadrupole – JLab Model

- The ion beam line has *6 main quadrupoles*; 3 upstream, 3 downstream
- The upstream quadrupoles are less demanding due to their smaller apertures
- The downstream quadrupoles have larger bores and are the most challenging
 - iQDS1a has a gradient of 37.23 T/m and beam aperture radius of 9.2 cm
 - iQDS1b has a gradient of 37.23 T/m and beam aperture radius of 12.3 cm
 - *iQDS2 has a gradient of 25.96 T/m and the largest beam aperture radius at 17.7 cm*
- The *peak field in the ion quadrupole coils is 6.4-7.0 T*
- The coils will be keystone Rutherford cable

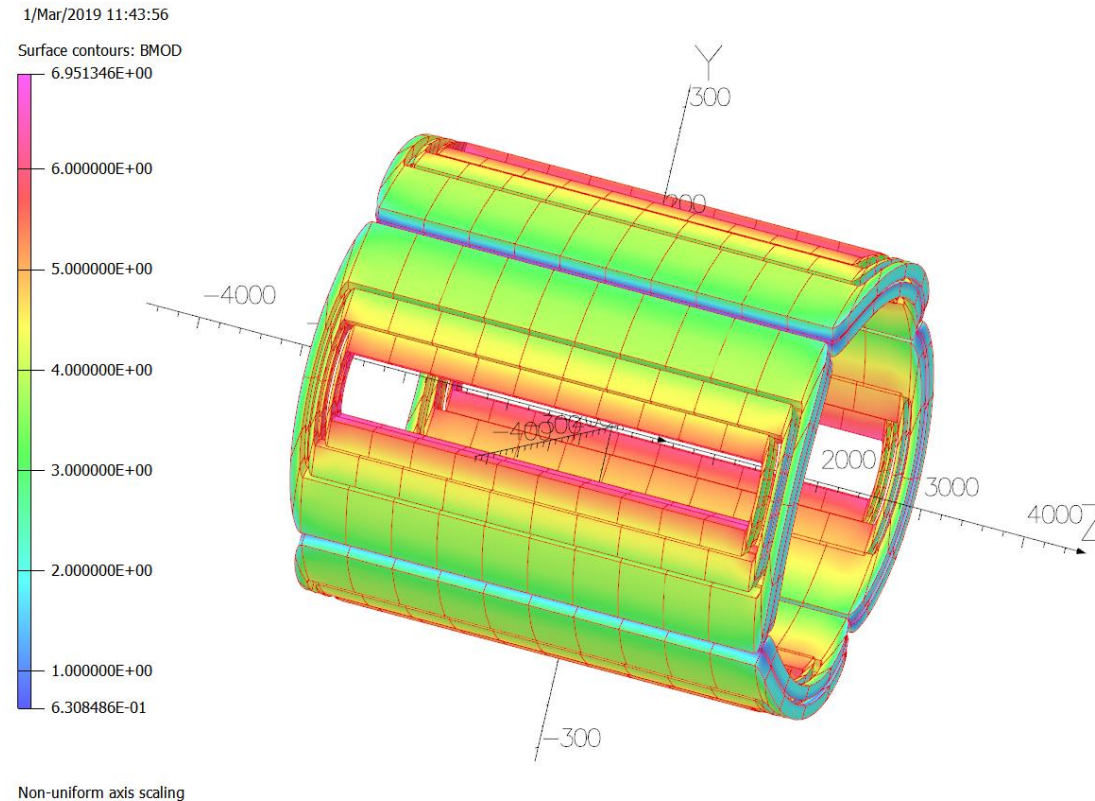

UNITS	
Length	mm
Magn Flux Density	T
Magnetic Field	A/m
Magn Scalar Pot	A
Magn Vector Pot	Wb/m
Current Density	A/mm ²
Elec Flux Density	C/m ²
Electric Field	V/m
Electric Pot	volt
Charge Density	C/cm ³
Conductivity	S/m
Power	W
Force	N
Energy	J
Mass	g
Pressure	Pa

MODEL DATA

6 conductors

Field Point Local Coordinates

Local = Global



This coil design is optimized to the first order. Further optimization is required to reduce the peak field in the coil ends and tailor multipoles.

Preliminary Electron Quad Analysis – LBNL Model

Goals:

- Perform a first-pass analysis for eQ(U/D)S(1-3)
- Obtain a preliminary design and performance parameters: **cable and coil geometry, operating current, margin to quench, fringe field, magnetic length and field quality**
- Iterate as needed, get feedback to/from AP

Coil and yoke geometry:

- **Single layer coil with ~8.5 mm width**
- Two coil blocks (one wedge) for control of geometric harmonics
- Inner coil radius at 53 mm (8 mm increase for inner vessel)
- Radial space reserved for collars: 8.7 mm (yoke IR 70 mm)
- Outer yoke radius 95 mm (specified range from 80 to 110 mm)

Superconductor and cable:

- **NbTi superconductor at 4.5K**
- Based on **MQY inner cable**: 22 strands, 0.735 mm diameter
- Larger aperture allows **decreasing keystone angle from 1.725 to 1.311 deg.** for improved mechanical stability and degradation

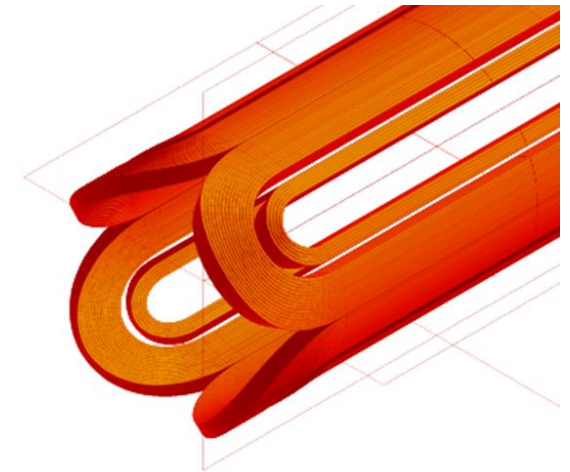
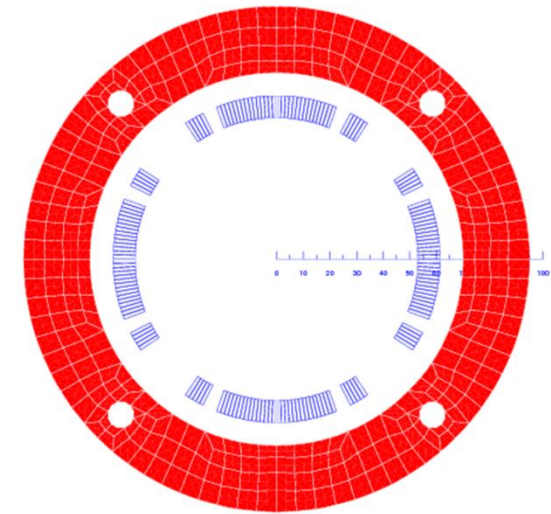

Preliminary Electron Quad Analysis – LBNL Model

- **2D FIELD QUALITY**
- Field quality **optimized and reported at 35 mm radius** (~2/3 of coil aperture, 53 mm)
- Good **field radius required by beam is 15-32 mm**: significant benefit for some quads
- Harmonics at nominal current can be optimized to $\ll 1$ "unit" (10^{-4} of quadrupole)
- However, b_6 saturation is several units (R=35 mm) in the absence of yoke optimization
- Yoke optimization for **saturation control will increase the fringe field: is it needed?**
- Random errors calculated for radial/azimuthal block displacements **with ± 100 mm range**
- Persistent current should be included: may be important for low field operational modes

- **3D FIELD QUALITY**
- **Large negative contribution to b_6 , b_{10} in the ends**
 - Due to conductor blocks lifting away from the mid-plane as they turn around the pole
- b_6 : -290 units peak, or -71.1 units integrated over a magnetic length (straight section equivalent) of 154.5 mm
- b_{10} : -28 units peak, or -4.6 units integrated over 154.5 mm
- Integral **can be corrected by body-end compensation or by end optimization** – with different advantages and disadvantages
- **Need AP evaluation and feedback for different options**

Random errors (1 sigma) for 100 μ m block displacements

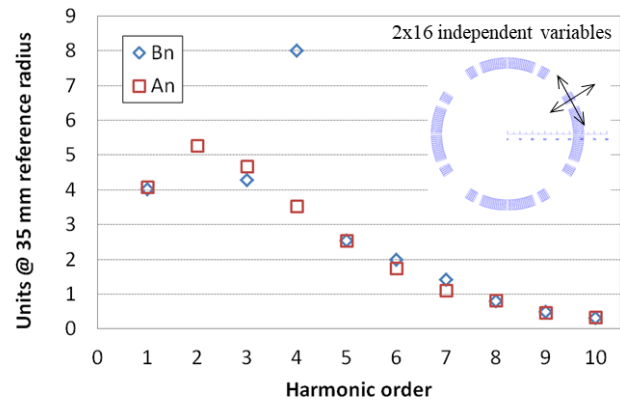

Saturation effect on b_6 (R=35 mm)

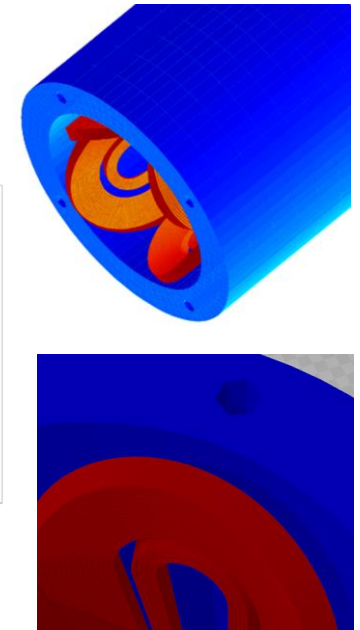
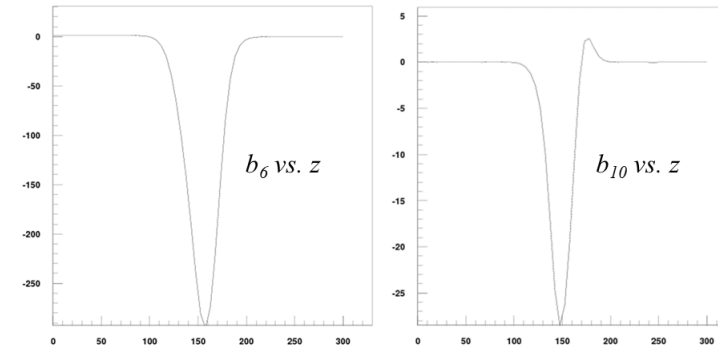
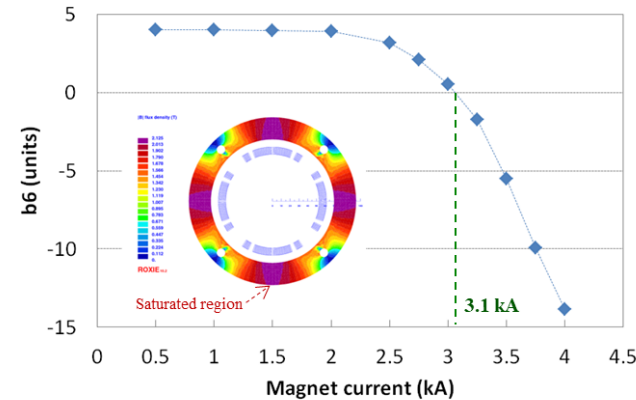

Magnet Field Quality: Geometric Errors

Interface with DA studies: field error table including **systematic, uncertainty on systematic, and random components**

Errors are defined **by harmonic expansion**:

$$B_y + iB_x = B_2 10^{-4} \sum_{n=1}^{\infty} \bar{c}_n \left(\frac{x + iy}{r_0} \right)^{n-1}$$

Harmonic coefficients combine **normal and skew components**:

$$\bar{c}_n = b_n + i a_n$$

Random errors:

- Effect of fabrication tolerances by Monte Carlo calculation
- Conductor positioning within $\pm 50 \mu\text{m}$ is usually achieved in $\cos\theta$ magnet production
- **Larger errors may be expected for first (only) units or other design/fabrication methods**
- Scaling data from production of similar magnets is also possible

Random errors (1 sigma) for $\pm 100 \mu\text{m}$ block displacements

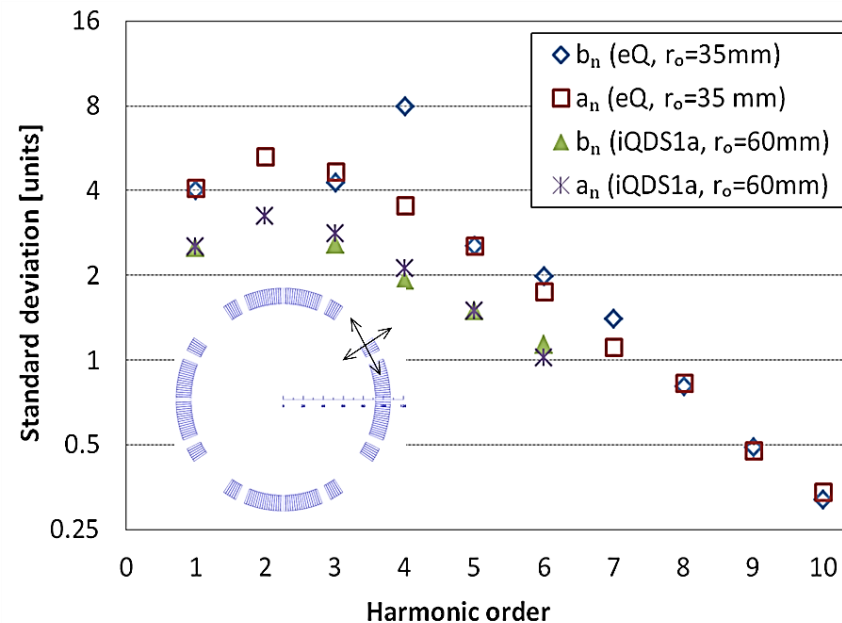

Systematic Effects: Iron Saturation

- Operation over a large energy/field range compared to other colliders
- Limited options for yoke optimization due to transverse space constraints
 - Increased distance between yoke OD and coil, increased iron thickness, introduction of features (e.g. holes) to make saturation more uniform
- Requires a specific analysis of each individual magnet
- Cross-section can be modified to shift of the entire curve by a fixed value

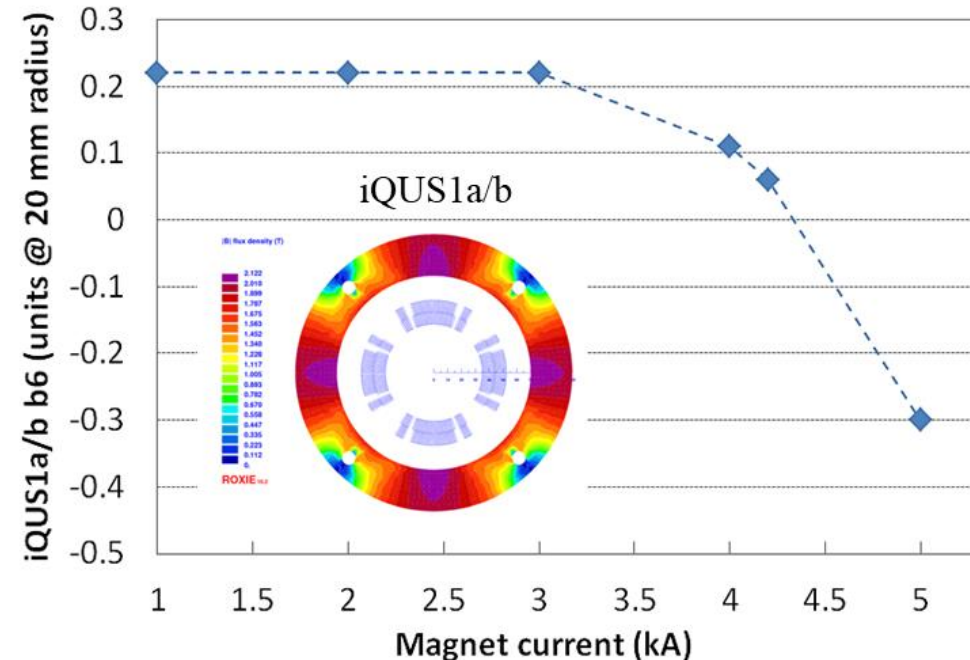
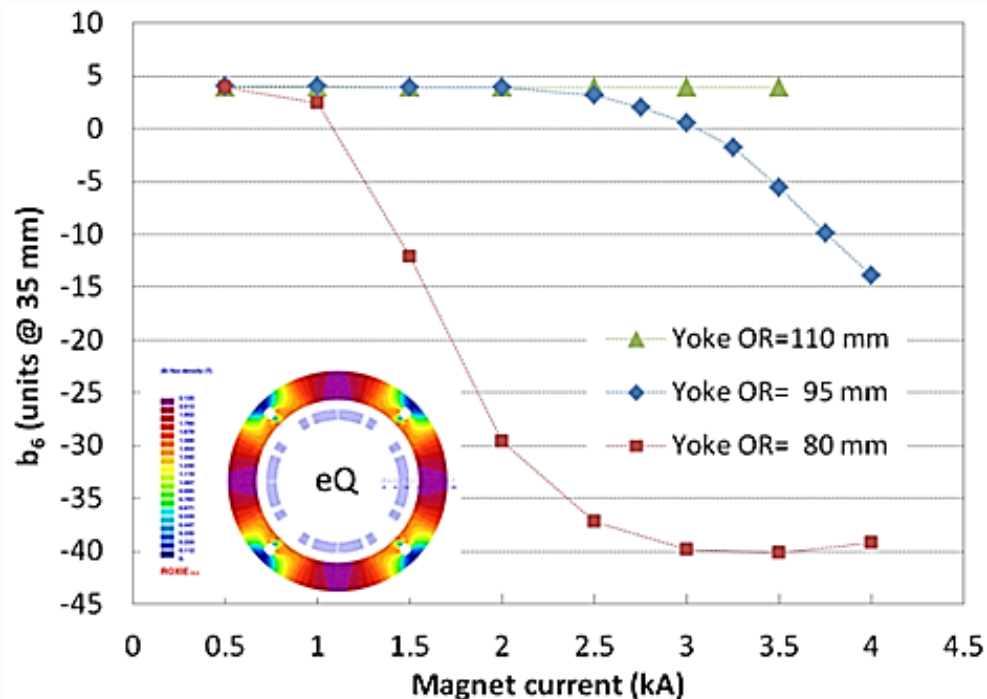

Coil End Optimization: Field Quality

- Integrated harmonics can be corrected with spacers but total magnet length will increase
- For higher order harmonics, need to split blocks
- Feedback from AP will provide guidance

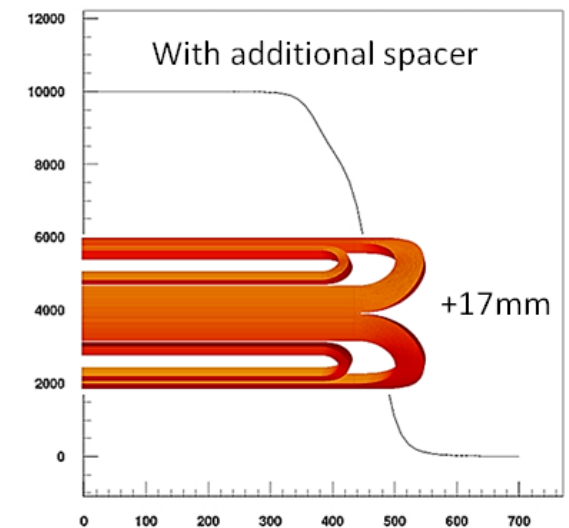
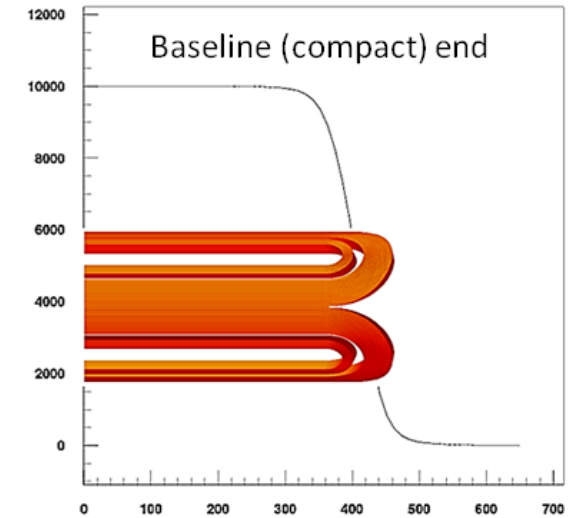
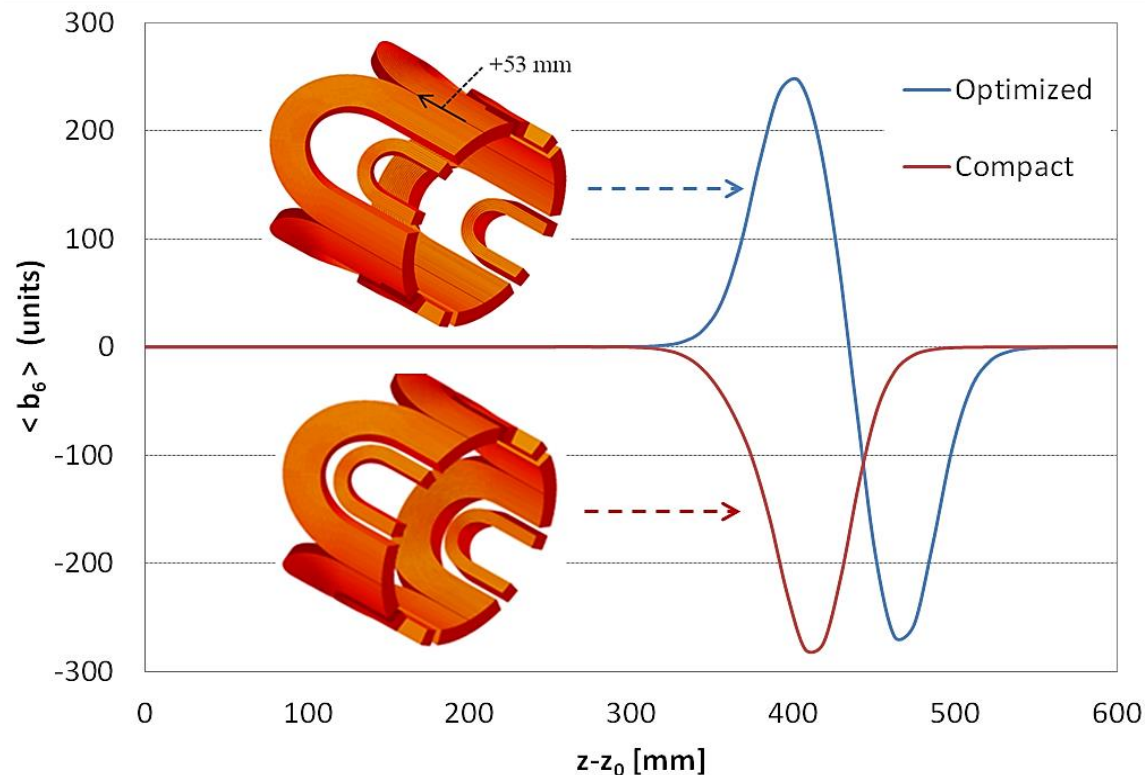

Coil End Optimization: Peak Field

- Coil field may increase by 10-20% in the ends
- Terminating the yoke would increase the fringe field
- Increased block spacing is required to avoid loss of margin

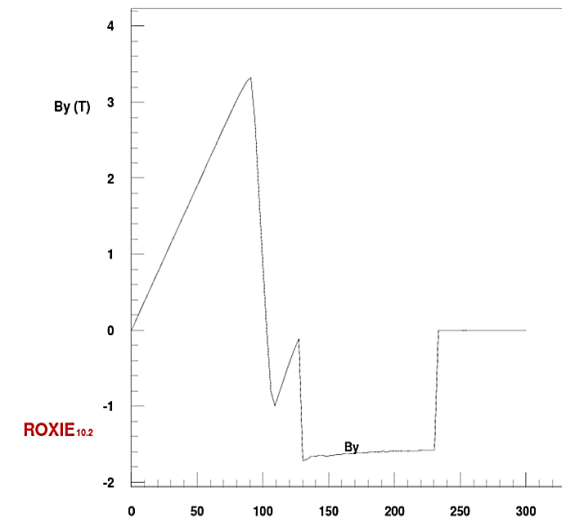
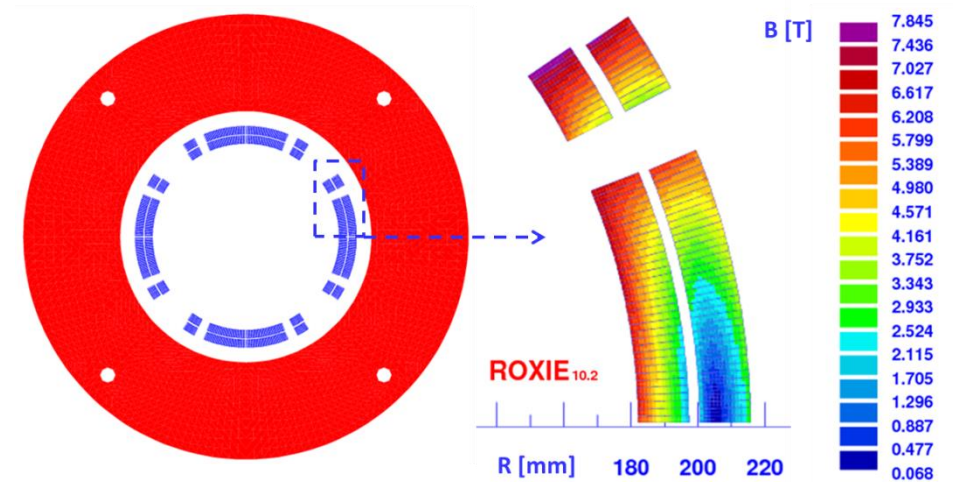
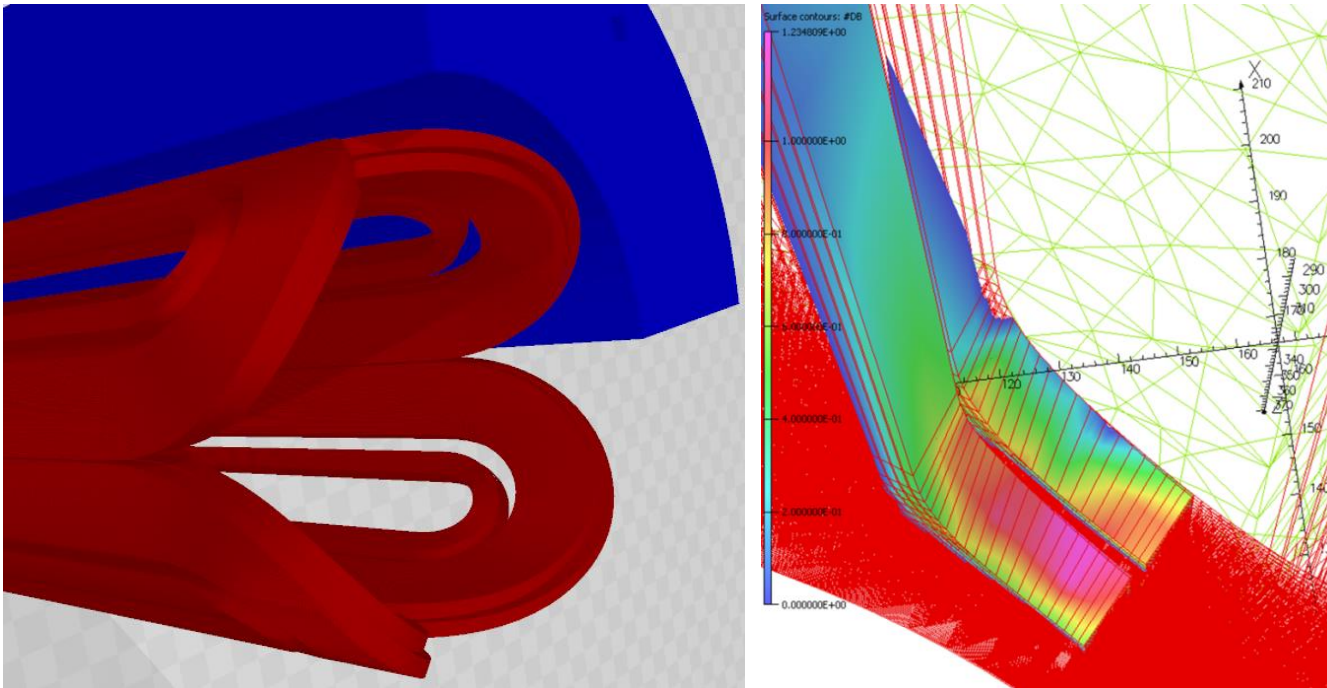

SR Impacts

- All interaction Region (IR) designs hinge on controlling machine induced backgrounds for the detector
- Need control of SR backgrounds from the final focus magnets and other upstream sources like the last bend magnet
 - Soften the last bend magnet as much as possible
 - Move it as far away as possible
- Final focus magnets need to be close enough to the collision point to keep the maximum beta function values “reasonable”, < 5000 m
- The final focus magnet design is an integral part of any Interaction Region
 - The magnet placements strongly influence detector acceptance for physics (usually something has to be given up or compromised since detectors want 4π SA)

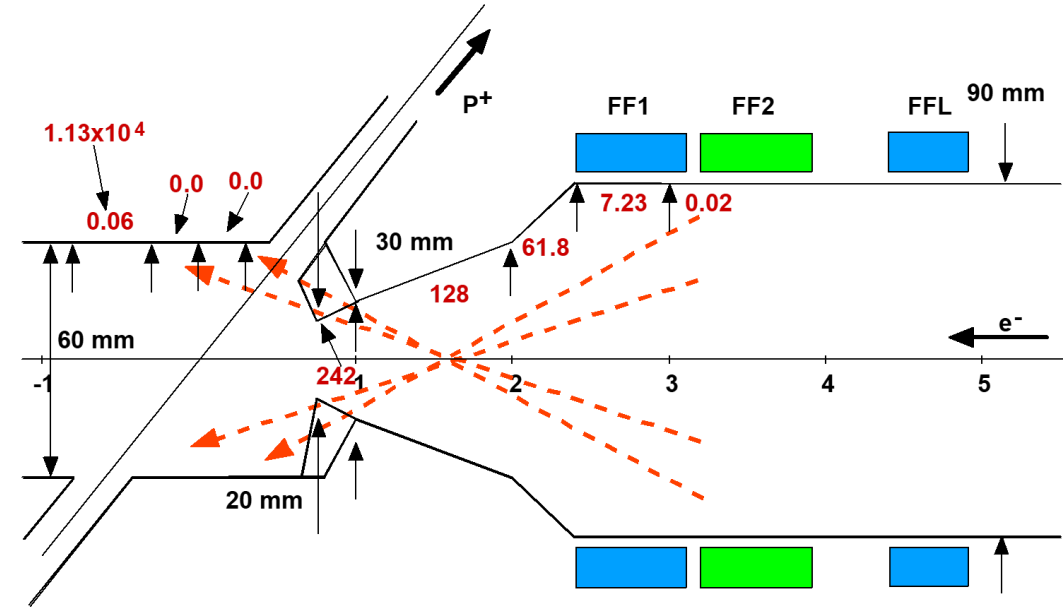

• 5 GeV beam

- β_x/β_y 10/2 cm
- ϵ_x/ϵ_y 5.5/1.1 nm-rad
- I 2.8 A
- BSC envelope is about $17\sigma_x$ and $45\sigma_y$
- Maximum X BSC is ± 22.3 mm at 4.075 m
- Maximum Y BSC is ± 28.5 mm at 2.95 m

• 10 GeV beam

- β_x/β_y 10/2 cm
- ϵ_x/ϵ_y 22/4.4 nm-rad
- I 0.71 A
- BSC envelope is about $14\sigma_x$ and $22\sigma_y$
- Maximum X BSC is ± 36.9 mm at 4.075 m
- Maximum Y BSC is ± 27.8 mm at 2.95 m

SR Impacts

- The focus has been on the IR beam pipe and masking of SR
- Measure of success is reduction of detector background
- Multiple iterations on the IR beam pipe
 - Reduce SR by masking
 - Consider impedance of the structure
- Specific engineering designs for these magnets may cause difficulties in both dynamic aperture size and in SR masking issues. We will have to keep a close watch on developments that alter the magnets as currently envisioned.

NEW BEAM PIPE CONFIGURATION: Mike Sullivan

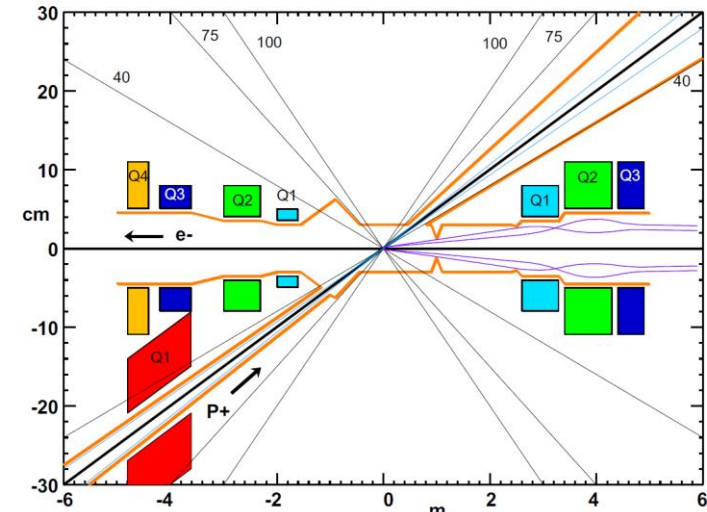

Initial Beam Pipe Design

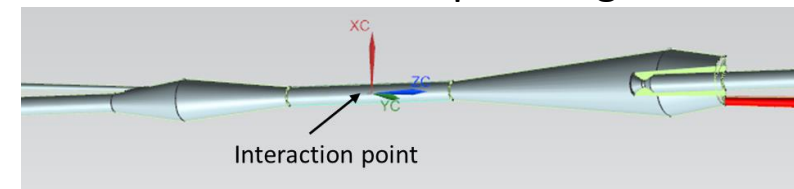

Revised Beam Pipe Design

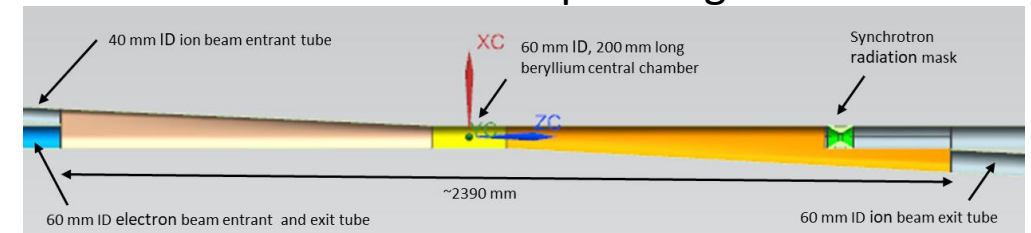

Publications

- G. Sabbi, B.R. Gamage, T.J. Michalski, V.S. Morozov, R. Rajput-Ghoshal, M. Wiseman, “**Field quality analysis of interaction region quadrupoles for JLEIC**”, NAPAC 2019, <https://napac2019.vrws.de/papers/moplo13.pdf>
- R. Rajput-Ghoshal, R. Fair, P. K. Ghoshal, G. Sabbi, “**Optimization of an Interaction Region Quadrupole Magnet for a Future Electron-Ion Collider at JLab**”, 26th International Conference on Magnet Technology (MT-26), in press.
- G. Sabbi, “**The IR Magnets for EIC**”, EIC User Meeting, Paris, July 2019, <https://indico.in2p3.fr/event/18281/contributions/71973/>
- R. Rajput-Ghoshal, C. Hutton, F. Lin, T. Michalski, V.S. Morozov, M. Wiseman, “**Optimization of an Interaction Region Quadrupole Magnet for a Future Electron-Ion Collider at JLab**”, paper TUZBA4, NAPAC2019, Lansing, MI, September, 2019. <https://napac2019.vrws.de/papers/tuzba4.pdf>
- V.S. Morozov, et.al., “**Full Acceptance Interaction Region Design of JLEIC**”, IPAC 2019, Melbourne, Australia, doi:10.18429/JACoW-IPAC2019-WEPGW123.
- Contribution to: B. Parker, et.al., “**Electron Ion Collider Machine Detector Interface**”, paper TUZBA2, NAPAC2019, Lansing, MI, September, 2019. <https://napac2019.vrws.de/papers/tuzba2.pdf>
- B.R. Gamage, et.al., “**Multipole Effects on Dynamic Aperture in JLEIC Ion Collider Ring**”, paper TUPLO15, NAPAC2019, Lansing, MI, September, 2019. <https://napac2019.vrws.de/papers/tuplo15.pdf>
- R. Rajput-Ghoshal, R. Fair, P. Ghoshal, C. Hutton, E. Sun, M. Wiseman, “**Conceptual Design of the Interaction Region Magnets for Future Electron-Ion Collider at Jefferson Lab**”, IEEE Transactions On Applied Superconductivity, Vol. 29, No. 5, August, 2019, DOI: [10.1109/TASC.2019.2901590](https://doi.org/10.1109/TASC.2019.2901590).

Next Steps and Future Work

- Further validate analytical multipoles against scaled, existing magnet data
- Optimize individual magnet multipoles, include yoke in magnet
- Optimize around one operational point
 - Will require assessment across the entire energy range of each collider ring
- Develop appropriate correction schemes for ECR and ICR
- Additional considerations:
 - Space allocation – tuning magnet ends tends to make them longer, yokes, shielding
 - Cryostats, mechanical supports, shielding magnet-magnet and magnet-adjacent beamline
 - Additional IR systems: IR beam pipe, region vacuum, IR beam pipe thermal management
 - Detector system considerations: backgrounds, SR mitigation, acceptance cone within IR magnets, shadows generated by external envelope affecting acceptance

Summary

- Changes were made to the magnet designs to support JLEIC project decisions; ion energy at 200 GeV and converting all SC magnets to NbTi
- The project is on track with progress and milestones
- All analysis models are functional, allowing for expedient iterations during optimization studies
- Random and systematic errors have been entered into the analytical models and impacts to dynamic apertures have been studied
- Studies of fundamental magnet parameters have been performed for coil end effects on multipoles and effects of yoke saturation limits
- SR studies have driven the design of the IR beam pipe
- The project has been the foundation or contributed to several conference publications and posters
- The project is expected to achieve all its objectives in year 2. Follow on R&D towards performance across the complete energy range and MDI topics is anticipated.

Thank you for your attention.

Questions?