

Critical Accelerator R&D for JLEIC

(Jefferson Lab EIC Collaboration)

Yuhong Zhang

Thomas Jefferson National Accelerator Facility

DOE-NP Accelerator R&D PI Meeting, 11/14/2016

Outline

- **Introduction**
- **Update on JLEIC Accelerator Design**
- **The DOE-ONP Supported R&D and Budget**
- **Descriptions of Projects**
- **Perspective of Future Accelerator R&D**
- **Summary**

Introduction

- Design of JLab EIC is aimed at delivering very high luminosities and polarization to meet science needs, with low technical risk & modest R&D requirement.
- The main JLEIC design concept/strategy has remained the same over the last 10 years, indicating a high level of maturity of the design.
- The implementation has been revised in the last two years in several areas to optimize performance, technology and cost.
- The key accelerator R&D topics have been identified, presently are under study by the JLab accelerator team and external collaborators.
- The support by DOE-ONP through the facility research grant is the most critical one. We thank DOE-ONP for this support and also are looking forward to continuity and expansion of the support.

Outline

- Introduction
- **Update on Accelerator Design**
- The DOE-ONP Supported R&D and Budget
- Descriptions of Projects
- Perspective of Future Accelerator R&D
- Summary

(Achieved) Design Goals Driven by Science

- **Energy** *(bridging the gap of 12 GeV CEBAF & HERA/LHeC)*
 - Full coverage of center-of-mass energy up to 63 GeV²
 - Electrons 3-10 GeV, protons 20-100 GeV, ions 12-40 GeV/u
- **Ion species**
 - Polarized light ions: p, d, ³He, (and a few polarized heavier ions)
 - Un-polarized light to heavy ions up to A above 200 (Au, Pb)
- **Up to 2 detectors**
- **Luminosity**
 - Greater than 10³³ cm⁻²s⁻¹ per IPs over a broad CM energy range
 - Maximum luminosity should optimally be around CM energy 45 GeV
- **Polarization**
 - At IP: longitudinal for both beams, transverse for ions only
 - All polarizations >70% desirable
- **Upgradeable to higher energies and luminosity**
 - 16 GeV electron, 250 GeV proton, and 100 GeV/u ion

Present JLEIC Baseline Layout

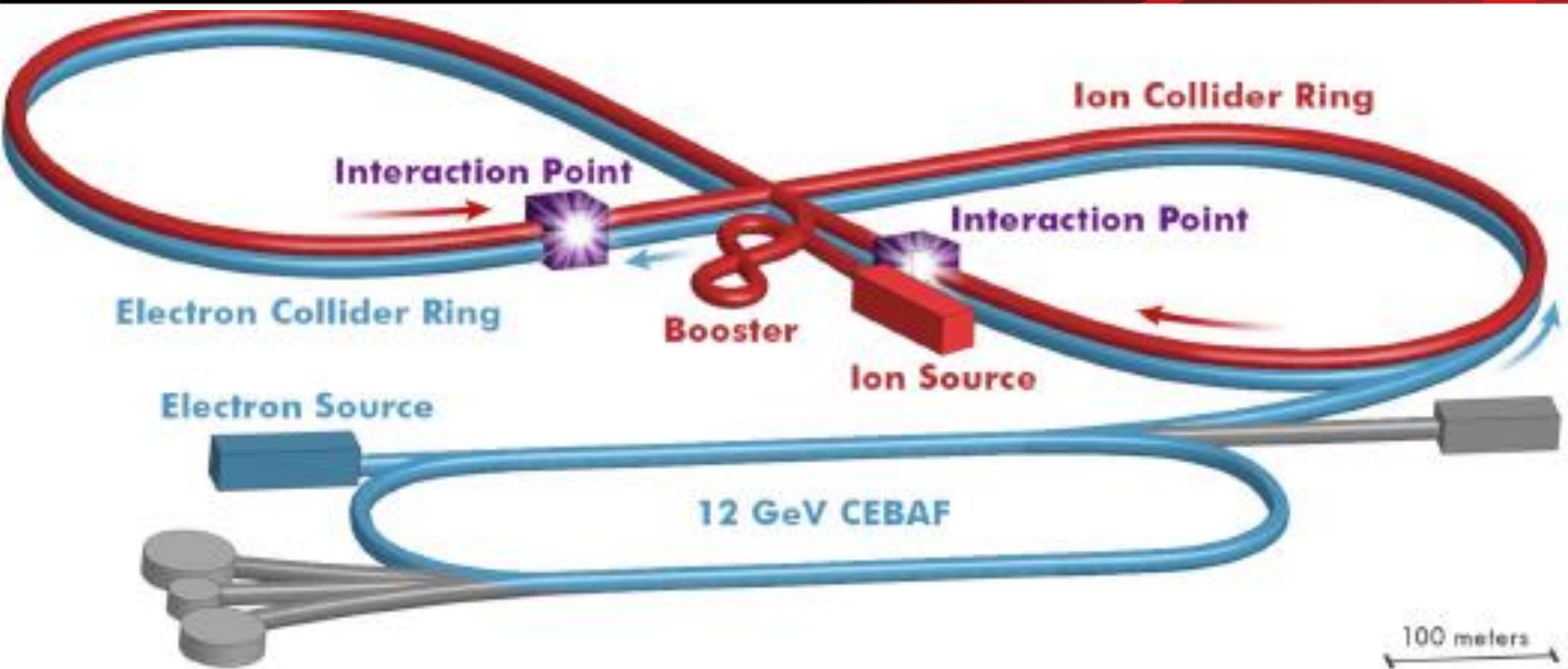

CEBAF is a **full energy injector**.
Only minor gun modification is needed

Strategy for Achieving High Performance

High Luminosity

- Based on high bunch repetition rate CW colliding beams

$$L = f \frac{n_1 n_2}{4\pi\sigma_x^* \sigma_y^*} \sim f \frac{n_1 n_2}{\epsilon\beta_y^*}$$

- KEK-B reached $> 2 \times 10^{34}$ /cm²/s
- However new for proton or ion beams

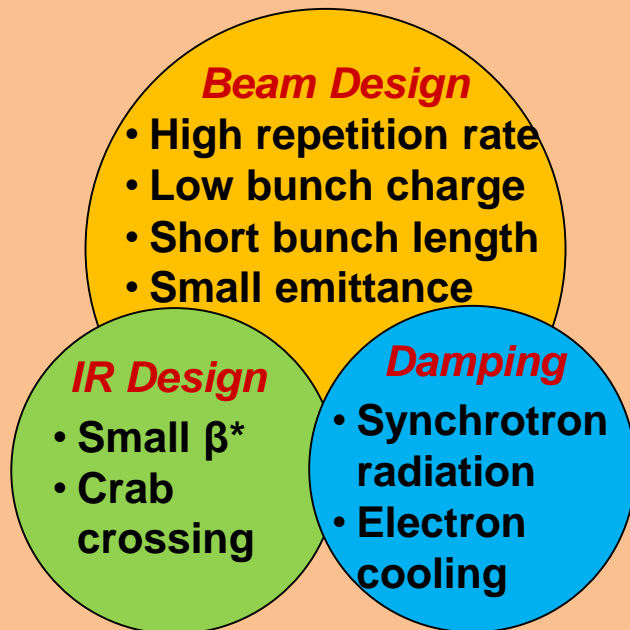

High Polarization

All rings are in a figure-8 shape

→ critical advantages for both beams

- Spin precessions in the left & right parts of the ring are exactly cancelled
- Net spin precession (*spin tune*) is **zero**, thus energy independent
- Spin can be controlled & stabilized by small solenoids or other compact spin rotators

Excellent Detection Capability

Interaction region is design to support

- Full acceptance detection (including forward tagging)
- Low detector **background**

JLEIC e-p Luminosity

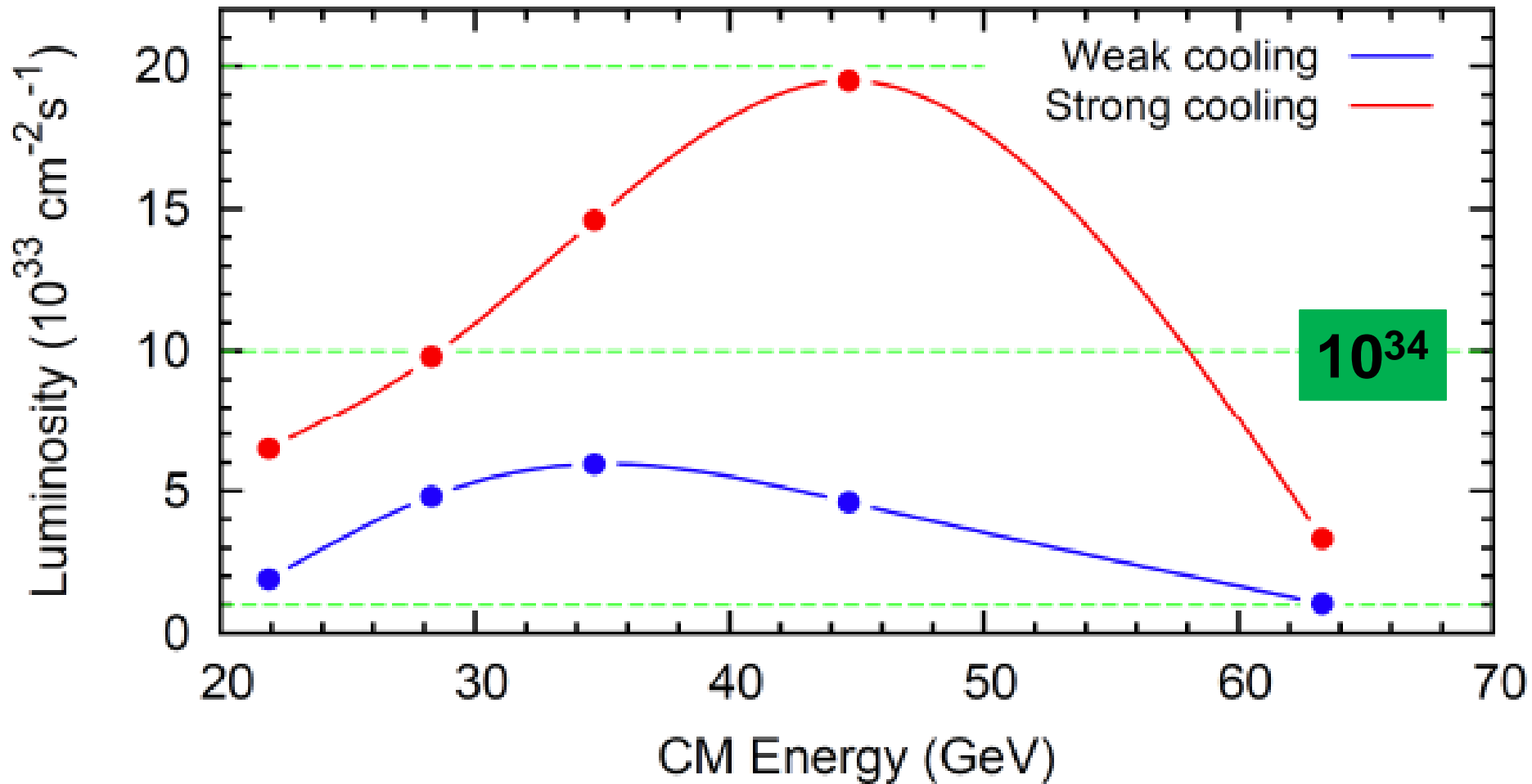

The baseline performance requires strong electron cooling – the bunched beam cooler is based on ERL and a circulator ring

Weak cooling means an ERL cooler without a circulator ring

MEIC/JLEIC Collaboration Meetings

Spring 2015 (3/30-31, 2015) no poster

Fall 2015 (10/5-7, 2015)

MEIC COLLABORATION MEETING FALL 2015

Thomas Jefferson National Accelerator Facility
Newport News, VA

October 5 - 7, 2015

Jefferson Lab has proposed MEIC, a polarized medium energy electron-ion collider based on the CEBAF recirculating SRF linac, as its future nuclear science program. The design studies and accelerator R&D of MEIC have been actively pursued by Jefferson Lab staff and external collaborators. This is the second collaboration meeting for MEIC. Its topic will be review of progress of the MEIC accelerator and detector design, and accelerator R&D.

Meeting will take place in the ARC Building, room 231/233.

CONTACT:
Audrey Barron,
anichols@jlab.org
757-269-7327

www.jlab.org/conferences/meic-oct15



Spring 2016 (3/29-31, 2016)

JLEIC COLLABORATION MEETING SPRING 2016

Thomas Jefferson National Accelerator Facility
Newport News, VA

March 29-31, 2016

JLEIC, a high luminosity polarized electron-ion collider based on the CEBAF recirculating SRF linac, has been proposed at Jefferson Lab as its future nuclear science program beyond 12 GeV CEBAF fixed target program. The design studies and accelerator R&D of JLEIC have been actively pursued over the last ten years by Jefferson Lab staff and external collaborators.

Meeting will take place in the CEBAF Center room F113

CONTACT:
Audrey Barron,
anichols@jlab.org
757-269-7327

<http://www.jlab.org/conferences/jleic-spring16/index.html>



Fall 2016 (10/5-7, 2016)

JLEIC COLLABORATION MEETING FALL 2016

Thomas Jefferson National Accelerator Facility
Newport News, VA

October 5-7, 2016

JLEIC, a high luminosity polarized electron-ion collider based on the CEBAF recirculating SRF linac, has been proposed at Jefferson Lab as its future nuclear science program beyond 12 GeV CEBAF fixed target program. The design studies and accelerator R&D of JLEIC have been actively pursued over the last ten years by Jefferson Lab staff and external collaborators.

Meeting will take place in the CEBAF Center room F113

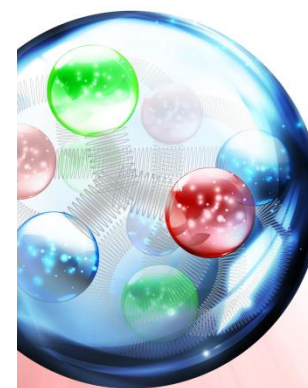

CONTACT:
Audrey Barron,
anichols@jlab.org
757-269-7327

<http://www.jlab.org/conferences/jleic-fall16/>



All talk slides archived in web

Outline

- Introduction
- An Overview of Accelerator Design
- **The DOE-ONP Supported R&D and Budget**
- Descriptions of Projects
- Perspective of Future Accelerator R&D
- Summary

DOE-ONP Direct Support to JLab EIC

- **FY10-12: *Advanced Electron Ion Collider Design***
 - Leader PI: Geoff Krafft
- **FY12-13: *Developments Towards a High Luminosity Polarized Electron Ion Collider***
 - Leader PI: Yuhong Zhang
 - Companion proposals from ANL, SLAC and Northern Illinois Univ. (*funded*), Old Dominion Univ. and Idaho State Univ. (*not funded*)
- **FY14-15: *Critical Accelerator R&D for Achieving High Performance of a Polarized Medium Energy Electron-Ion Collider***
 - Leader PI: Yuhong Zhang
 - Companion proposals from ANL and SLAC (*funded*), and Texas A&M Univ. (through reprioritization/reprogramming)
- **FY16: *Critical Accelerator R&D for Jefferson Lab Electron-Ion Collider***
 - Leader PI: Fulvia Pilat

FY14-15: Critical Accelerator R&D for Achieving High Performance of a Polarized Medium Energy Electron-Ion Collider

Project 1: Interaction Region

- Task 3.1: Optimization of Momentum Acceptance and Dynamic Aperture

Project 2: Polarized Beams in Figure-8 Ring

- Task 4.1: Electron Polarization Tracking
- Task 4.2: Ion Beam Polarization

Project 3: Technology Development

- Task 5.1: RF System R&D for MEIC
- Task 5.2: Design Studies and Proto-typing of Super-ferric Magnets

FY16: Critical Accelerator R&D for JLEIC

Jefferson Lab

Task 1: Studies of Cooling and Beam Transport in the ERL Cooler

Task 2: Development of Ion Polarization Design

Task 3: Simulations of Beam-Beam and related collective effects

Task 4: Design of Harmonic Fast Kicker

Argonne National Laboratory

Task 1: Design and Cost Optimization of the Linac

SLAC National Accelerator Laboratory

Task 1: Interaction Region (IR) Design Optimization

Task 2: Lattice Design and Single-Particle Dynamics

Texas A&M University

Task 1: Super-ferric Dipole 1.2m Prototype

Annual Budget and Total Received to Date

LAB 10-339 - Advanced Electron Ion Collider PI: Geoff Krafft

\$K	FY10+FY11	FY12+FY13	FY14+FY15	FY16	Totals
a) Funds allocated	\$779.6				\$779.6
b) Actual costs to date	\$779.6				\$779.6

LAB 12-632 - Developments Towards a High Luminosity Polarized Electron-Ion Collider PI: Yuhong Zhang

\$K	FY10+FY11	FY12+FY13	FY14+FY15	FY16	Totals
a) Funds allocated		\$734.0			\$779.6
b) Actual costs to date		\$731.5			\$731.5

LAB 14-1082 - Critical Accelerator R&D for Achieving High Performance of a Polarized Medium Energy Electron-Ion Collider PI: Yuhong Zhang

\$K	FY10+FY11	FY12+FY13	FY14+FY15	FY16	Totals
a) Funds allocated		\$47.9	\$692.0		\$739.9
b) Actual costs to date		\$47.9	\$640.7		\$688.6

LAB 14-1082 - Critical Accelerator R&D for JLEIC PI: Fulvia Pilat

\$K	FY10+FY11	FY12+FY13	FY14+FY15	FY16	Totals
a) Funds allocated				\$300	\$300
b) Actual costs to date				\$202	\$202

Outline

- Introduction
- Update on Accelerator Design
- The DOE-ONP Supported R&D and Budget
- **Description of Projects**
 - ERL Cooler Development
 - RF Fast Kicker
 - Bunched Beam Electron Cooling Experiment **(not supported)**
 - Nonlinear Beam Dynamics **(M. Sullivan presentation)**
 - Machine-Detector-Interface & SR **(M. Sullivan presentation)**
 - Ion Polarization
 - RF System R&D
 - Super-ferric Magnet **(P. McIntyre presentation)**
 - Ion Linac **(B. Mustapha presentation)**
- Perspective of Future Accelerator R&D
- Summary

Multi-Step Cooling for High Performance

- **Cooling of JLEIC protons/ions**

- achieves a small emittance
- achieves short bunch length (w/ strong SRF)
- enables strong final focusing & crab crossing
- suppresses IBS, maintaining beam emittance
- expands luminosity lifetime

- **JLEIC adopts conventional electron cooling**

- Well established in low energy DC regime

- **Multi-step scheme**

- taking advantages of high cooling efficiency at low energy or/and with small emittance

Ring	Cooler	Function	Ion energy	Electron energy
			GeV/u	MeV
Booster	DC	accumulation of positive ions	0.11~0.19 (injection)	0.062 ~ 0.1
		Emittance reduction	2	1.1
Collider	Bunched Beam (BB)	Maintain emittance during stacking	7.9 (injection)	4.3
		Maintain emittance	Up to 100	Up to 55

$$\tau_{cool} \sim \gamma^2 \frac{\Delta\gamma}{\gamma} \sigma_z \varepsilon_{4d}$$

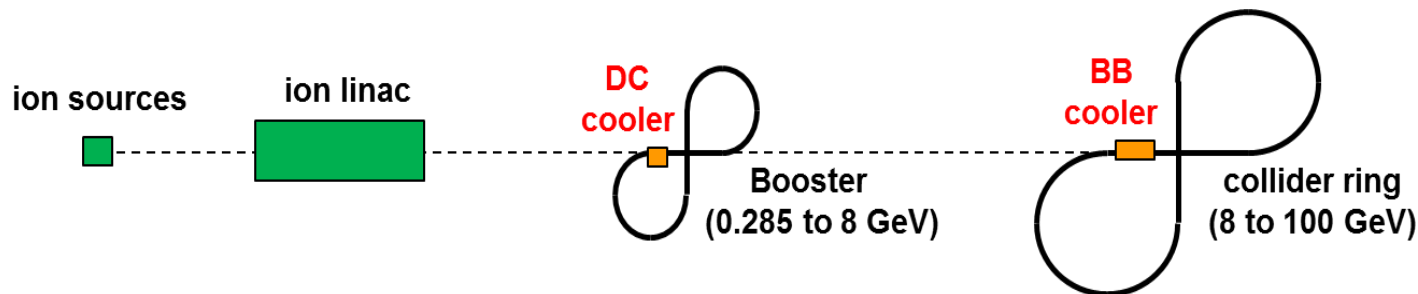

ERL Circulator Cooler Concept

Design Choices

- Energy Recovery Linac (ERL)
- Compact circulator ring to meet design challenges
- Large RF power (up to 81 MW)
- Long gun lifetime (average 1.5 A)

Required technologies

- High bunch charge (2 nC) magnetized gun
- High current ERL (55 MeV, 15 to 150 mA)
- Ultra fast kicker

Cooler development team

- S. Benson (leader), Ya. Derbenev, D. Douglas, H. Fay, Y. Huang, R. Li, F. Marhauser, F. Pilat, R. Rimmer, Y. Roblin, M. Spata, C. Tennant, H. Wang, H. Zhang, Y. Zhang

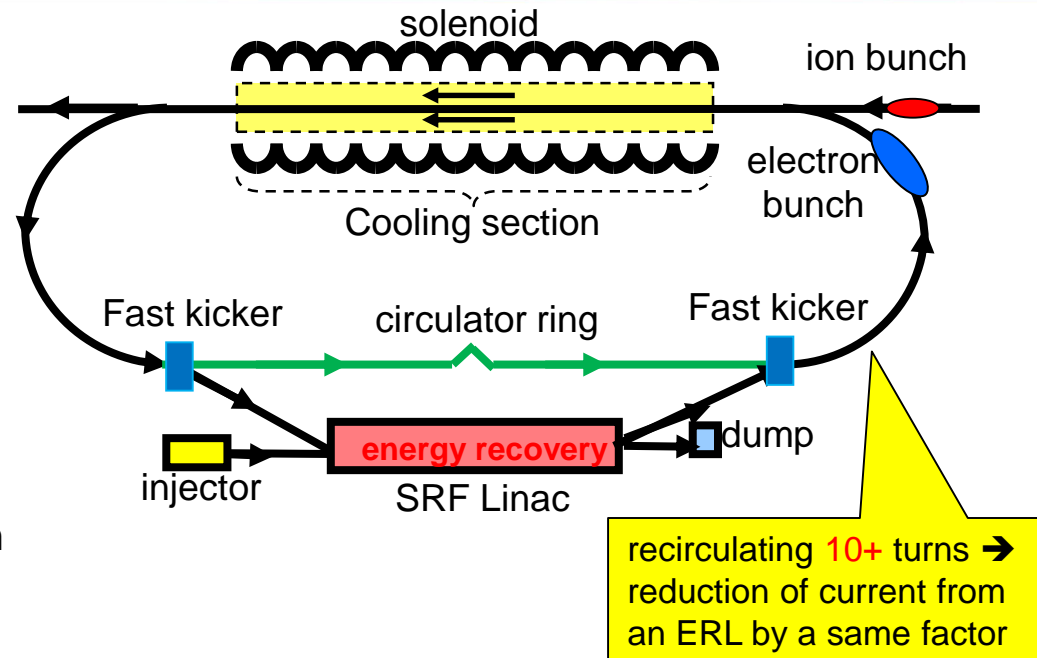

Previous works

- **Using ERL technology**
(Ben Zvi, *et.al.* 2000~2007)
- **Using circulator ring**
(Brinkman, *et.al.* ~1997)

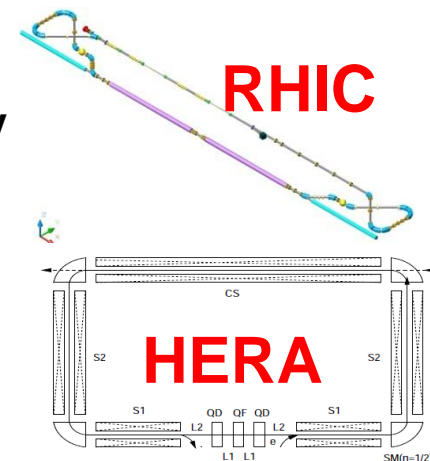

ERL Cooler Specification and Architecture

1st stage of ERL cooler development: single pass, without a circulator ring

Electron		
Energy	MeV	20 – 55
Bunch charge	pC	420
Linac frequency	MHz	952.6
Bunch shape		beer can
Bunch length (tophat)	cm	2 (23°)
Thermal emittance	mm-mrad	<19
Cathode spot radius	mm	2.2
Magnetic field at cathode	T	0.1
Gun voltage	kV	400
Normalized emittance (horizontal drift)	mm-mrad	36
Energy spread, uncorr. (RMS)	10^{-4}	3
Energy spread (p-p corr.)	10^{-4}	6
Cooling solenoid length	m	2x30
Cooling solenoid field	T	1
Electron beta in cooler	cm	37.6

Protons			
Energy	GeV	100	44.7
Particles/bunch	10^{10}	2	6.6
Bunch length (RMS)	cm	2.5	1
Normalized emittance, x/y	mm-mrad	1.2/0.6	1/0.5
Beta function in cooler	m	100	100

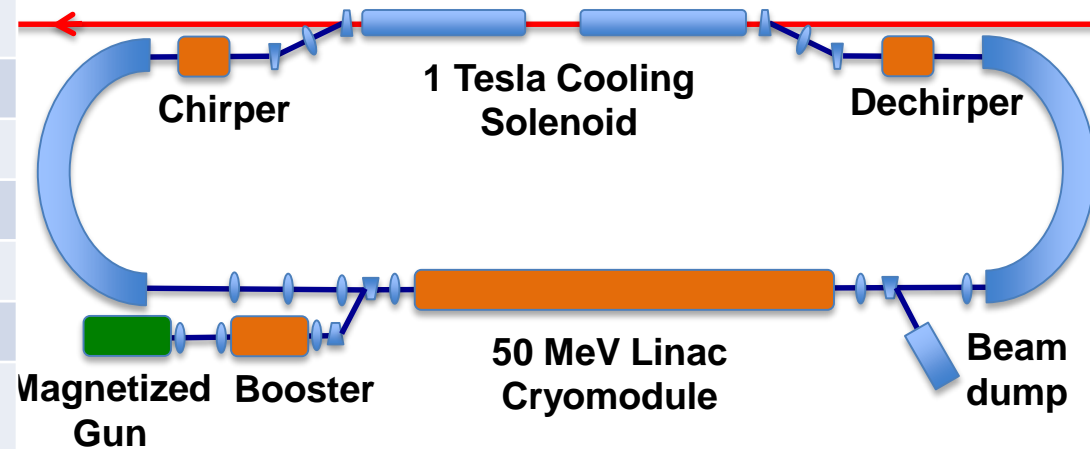

- Same-cell energy recovery in SRF cavities
- Dechirper and chirper before and after solenoid
- Bends
- Dump energy recovery

ERL Cooler Arc Architecture

- Utilize indexed dipoles to provide azimuthally symmetric focusing \rightarrow preserve magnetization
- Avoid envelope modulation \rightarrow avoid space charge driven degradation
- With uniform bending, the dispersion is large and it is difficult to achieve desired R_{56}
 - introduce reverse bending
- Three bend achromats (TBA) with *reversed* center bend
- 2 four-period achromats
 - TBA period, $\frac{1}{4}$ -integer tunes
 - angles chosen to set compaction ($\theta_1=20.4031^\circ$, $\theta_2=18.1531^\circ$)

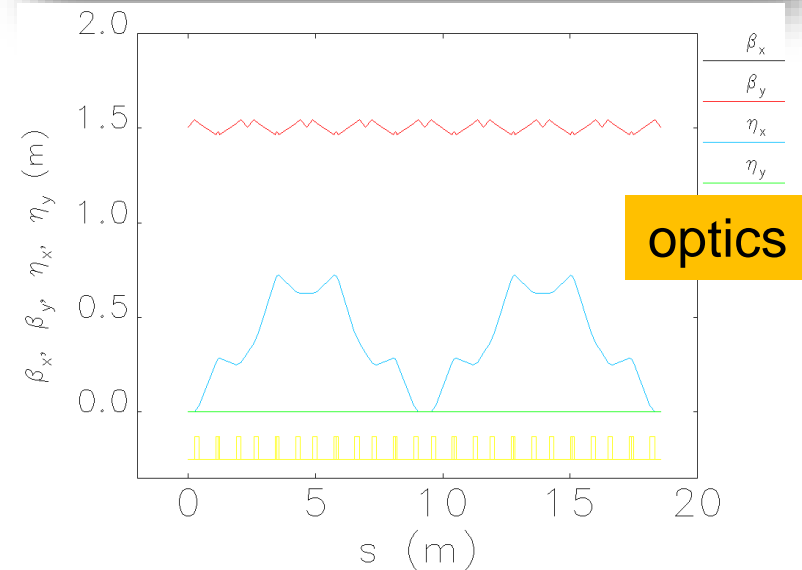
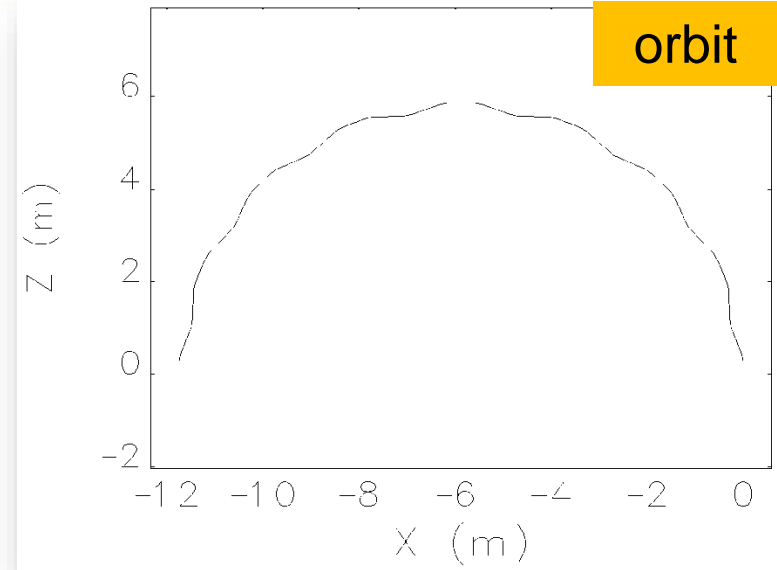

Beam Dynamics Simulation in ERL Cooler

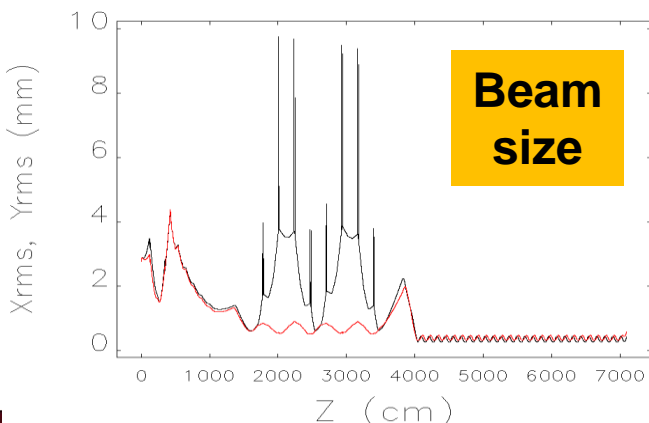
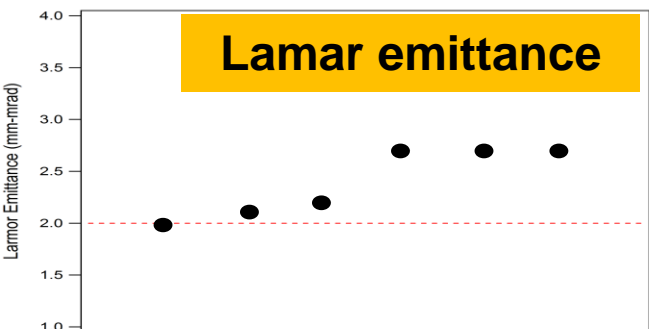
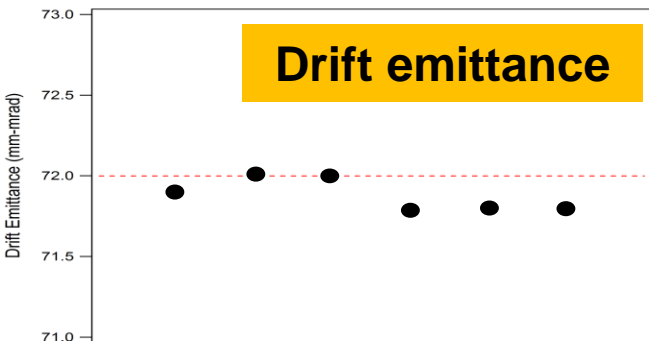

distribution from the front end (5.9 MeV/c)

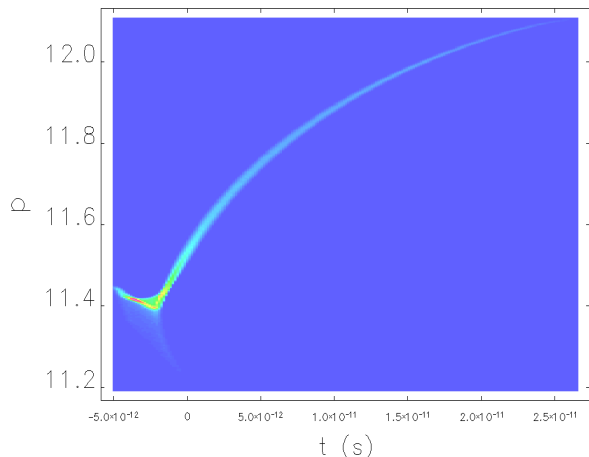

frequency as a function of t and p

Cooling solenoid entrance (matching not optimized)

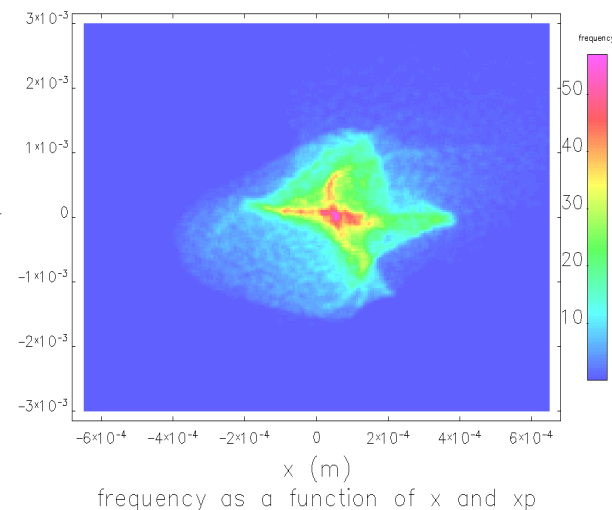

- Still need better injector solution. Hard to get uniform beam
- Space charge does not seem to be hurting us.
- Helicity spin flip appears to be straightforward
- Some early progress with merger design
 - Indexed dipole Penner bend
 - RF kicker
 - Bent solenoid

RF Fast Kicker for Circulator Cooler Ring

- Fast kicker for electron bunches exchange between ERL and CCR
 - multiple harmonic modes generated by a group of QWRs.

- Total kick voltage from all harmonic modes is:

$$V_t = V_0 + \sum_{n=1}^N V_{tn} \cos(n\omega_0 t + \varphi_n)$$

- Relationship between cavity number M and maximum harmonic number N: $2^M - 1 \leq N$

- QWR-based Deflecting Cavities

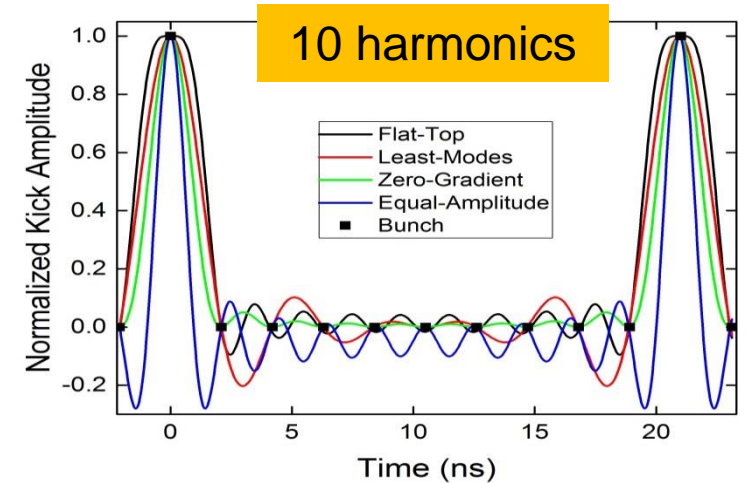
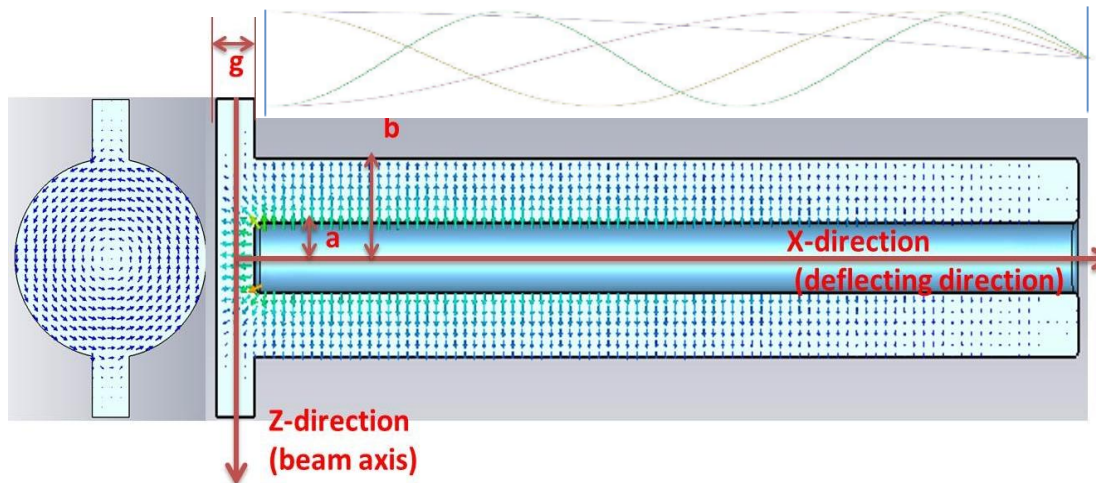
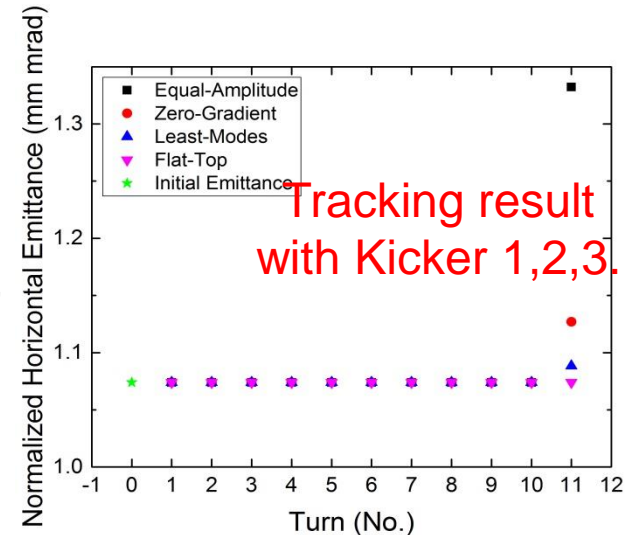
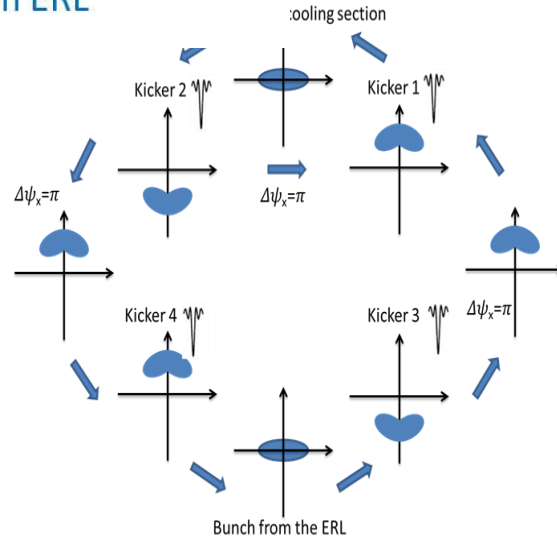
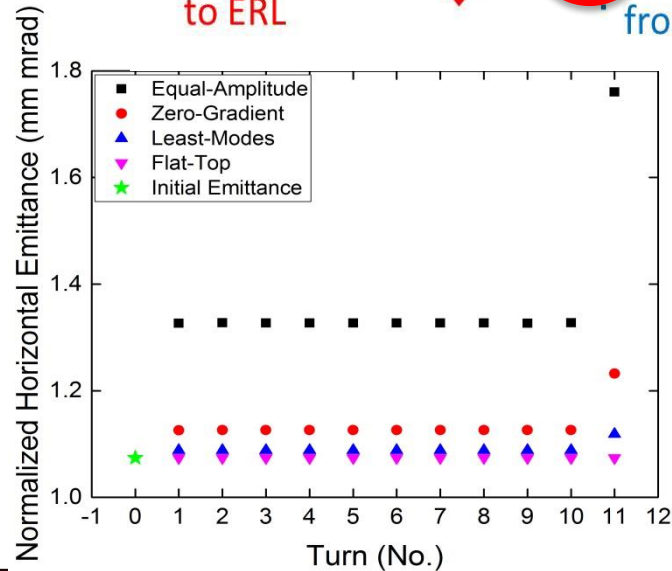
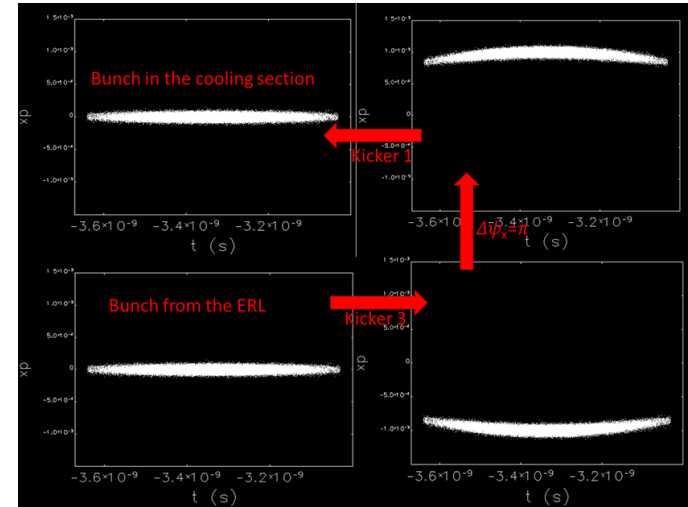
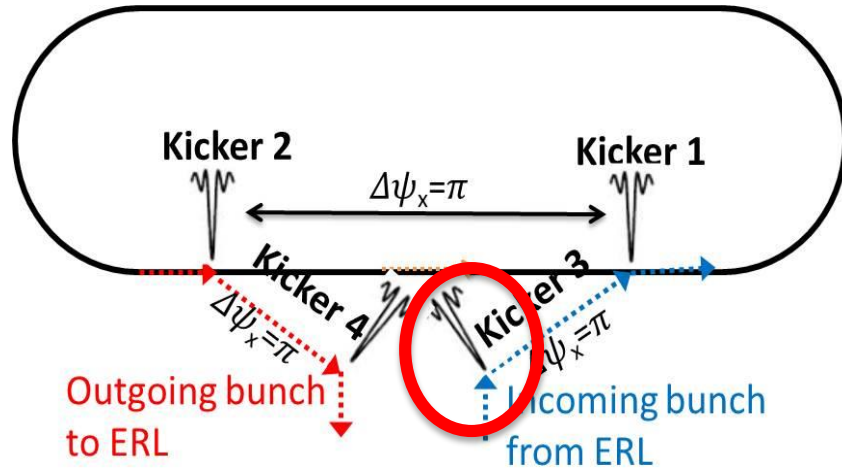

TABLE I. Normalized Kick Amplitude for Each Harmonic.

Mode (MHz)	Flat-Top	Zero-Gradient	Least-Modes	Equal-Amplitude
47.63	0.249	0.180	0.200	0.100
95.26	0.227	0.160	0.200	0.100
142.89	0.192	0.140	0.200	0.100
190.52	0.148	0.120	0.200	0.100
238.15	0.100	0.100	0.100	0.100
285.78	0.053	0.080	—	0.100
333.41	0.012	0.060	—	0.100
381.04	-0.022	0.040	—	0.100
428.67	-0.044	0.020	—	0.100
476.3	-0.055	—	—	0.100
DC	0.140	0.100	0.100	—
Total	1.000	1.000	1.000	1.000

Compensation of Kicking Pulse Curvature

- RF pulse curvature can cause emittance growth
- Introducing pre-distortion & Post-distortion Kicker



4-Cavity Model Based on Flat-Top Scheme

5 harmonics $47.63\text{MHz} \times 1, 3, 5, 7, 9$

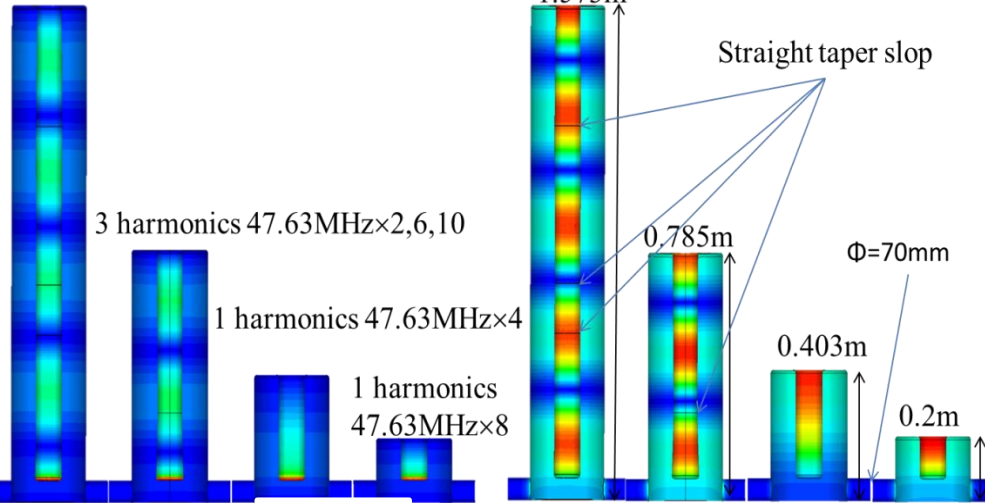

**Half Scale
Copper Prototype**

Calculated electromagnetic parameters of each mode for room temperature copper.

Cavity	Operation Frequency (MHz)	Q_0	Flat-Top Kick Voltage (kV)	Transverse Shunt Impedance (Ω)	Dissipated Power (W)
Five-Mode Cavity	47.63	8586	13.711	$7.527\text{E}6$	24.98
	142.89	14689	10.532	$3.954\text{E}6$	28.05
	238.15	18973	5.503	$2.916\text{E}6$	10.39
	333.41	22472	0.630	$1.859\text{E}6$	0.21
	428.67	25536	-2.432	$1.131\text{E}6$	5.23
Three-Mode Cavity	95.26	12002	12.462	$1.080\text{E}7$	14.38
	285.78	20784	2.917	$4.082\text{E}6$	2.08
	476.3	27056	-3.011	$1.560\text{E}6$	5.81
One-Mode Cavity	190.52	15298	8.129	$1.153\text{E}7$	5.73
One-Mode Cavity	381.04	19435	-1.209	$8.861\text{E}6$	0.17
DC Offset			7.768		
Total			55	$3.117\text{E}7$	97.03

Fabrication Details

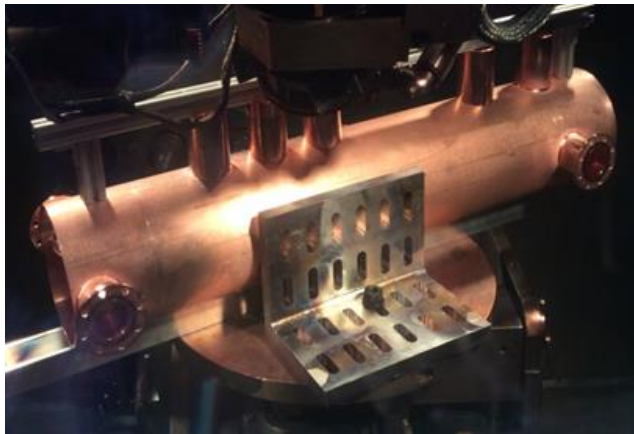

EBW of the outer conductor with the tuner pipes

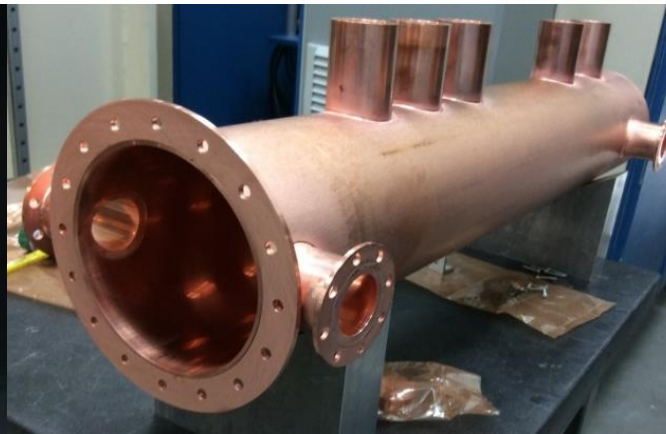

EBW of the outer conductor with electric end flange



Stub tuners detail

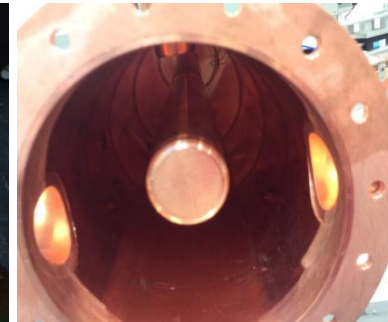
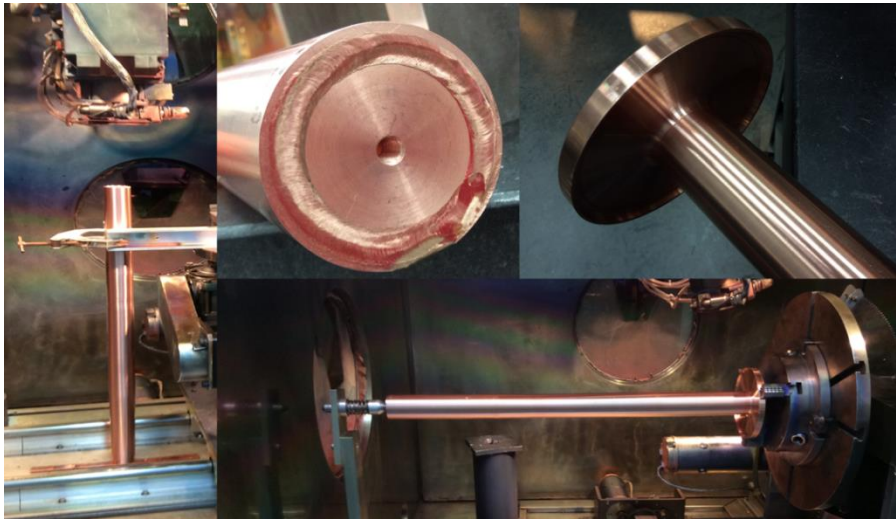

inner conductor cap threaded to the inner conductor bar

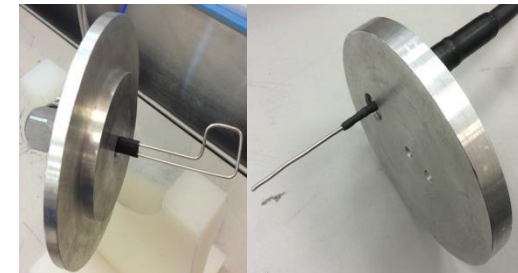

Loop coupler and pickup antenna

EBW of the inner conductor to the Magnetic End flange

Modes Combination Experiment

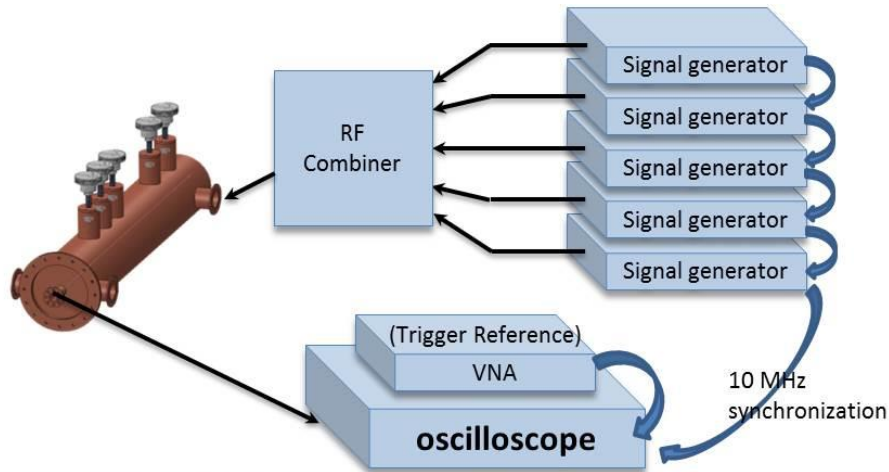

The mode combination results with each mode added in turn starting with the lowest mode.

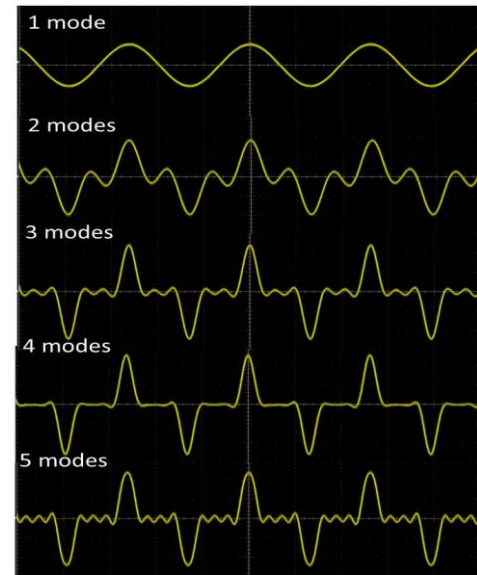

Comparison of the combined kick pulse captured from the oscilloscope display with the simulation

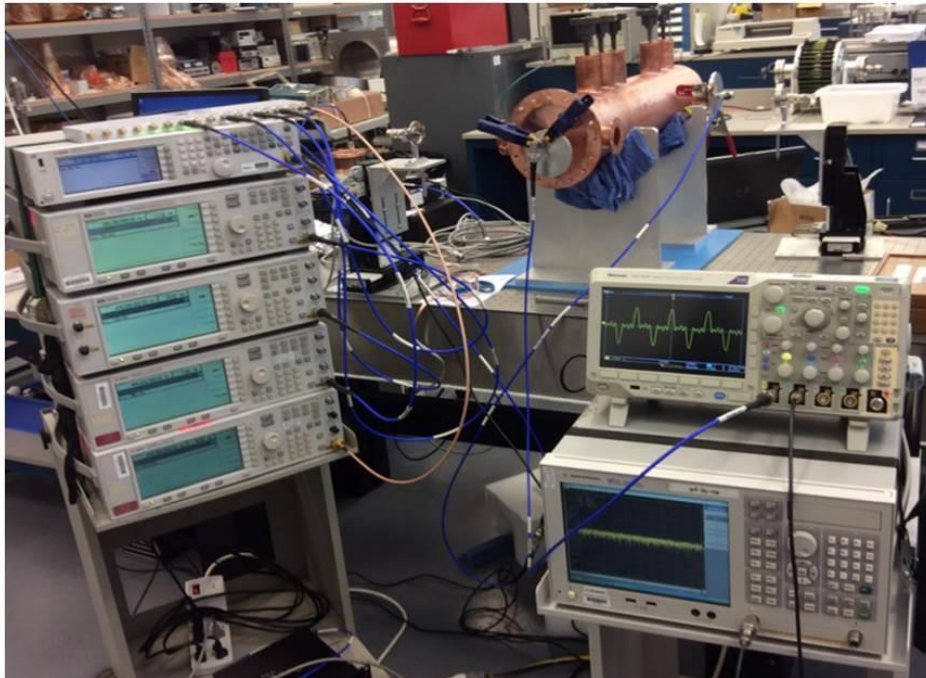
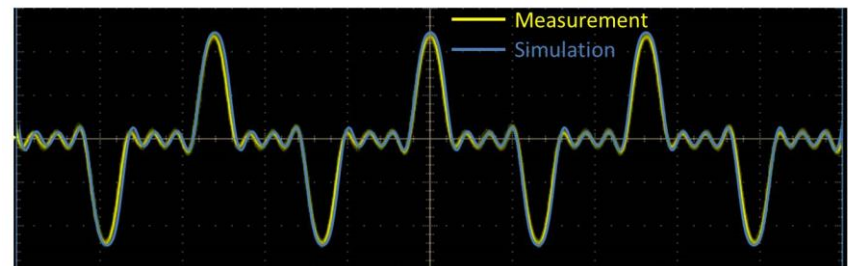

Cooling by a Bunched e-Beam: P-of-P Test

- All electron cooling to this day were performed using a DC electron beam.
- It is generally believed ions can be cooled by a bunched electron beam, however this has never been demonstrated experimentally before
- A proof-of-principle (P-o-P) experiment was proposed utilizing an existing DC cooler: replacing a thermionic gun by a photo-cathode gun, using the driven laser to control the bunch length (very short) & bunch rep. rate (very high).
- The idea further evolved to utilize a method of modulating grid voltage of a thermionic gun to generate a pulsed e-beam (pulse length as short as ~100 ns)
- A collaboration was initiated between Jlab and IMP
- We received a JLab LDRD grant (Y. Zhang, PI) to further develop and design the experiment. IMP received a grant from Chinese Academy of Science for supporting international collaboration (L. Mao as the PI)

Summary of The Experimental Results

- The first experiment of cooling of ions by a non-coasting electron beam was carried out this May at a DC Cooler at IMP by a JLab-IMP collaboration team
- The pulsed e-beam with 2 μ s to 60 ns FWHM pulse length was generated in the thermionic gun of the IMP DC cooler
- In this experiment, cooling of ions (either bunched or coasting) by a pulsed electron beam was observed through BPM measurements.
- The grouping/bunching effect of pulsed beam electron cooling was also observed in the case of coasting ion beam
- The team has collected a large amount of experiment data, they are primarily BPM data. Analyses of these experiment data is in progress.
- 1D longitudinal dynamic modeling with/without RF and the pulsed electron cooling is under development with promised results to explain observed experiment data
- **The 2nd experiment was scheduled at the end of this month, primarily for machine development**
- **The 3rd experiment is likely at April or May, 2017, for pushing short e-pulse length**

IMP DC Cooler on CSRm

DC cooler



Thermionic gun

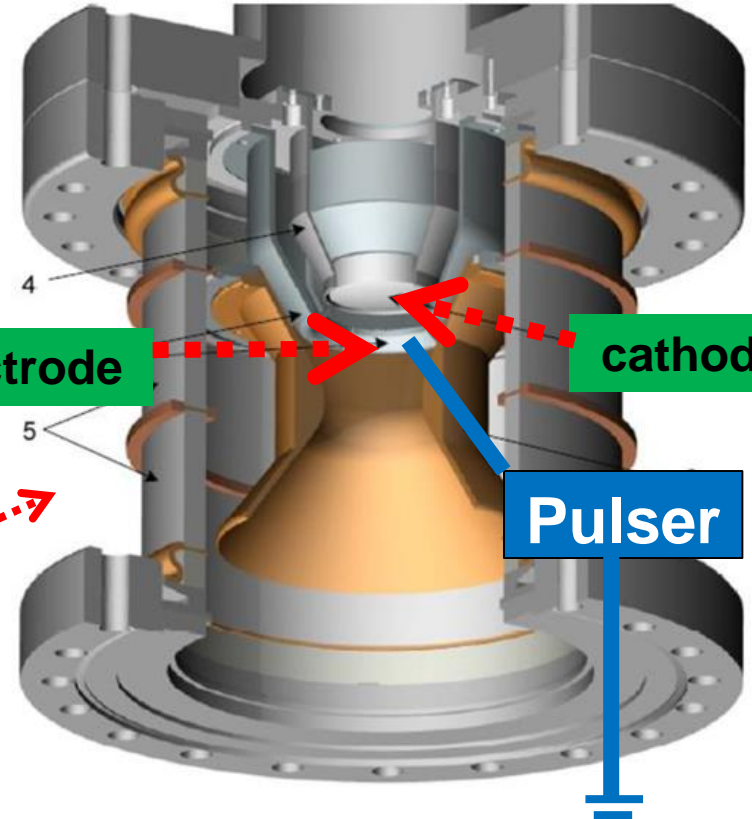

electrode

cathode

Pulser

CSRm ring



图 1 CSRm 电子冷却装置

Fig.1 The sketch of the electron gun

1 – four-sector control electrode, 2 – oxide cathode, 3 – anode, 4 – cathode housing, 5 – ceramics.

1 电子枪, 2 静电偏转板, 3 弯曲螺线管, 4 冷却段螺线管, 5 盖板, 6 收集器, 7 校正二极铁, 8 真空管道, 9 束流位置探针

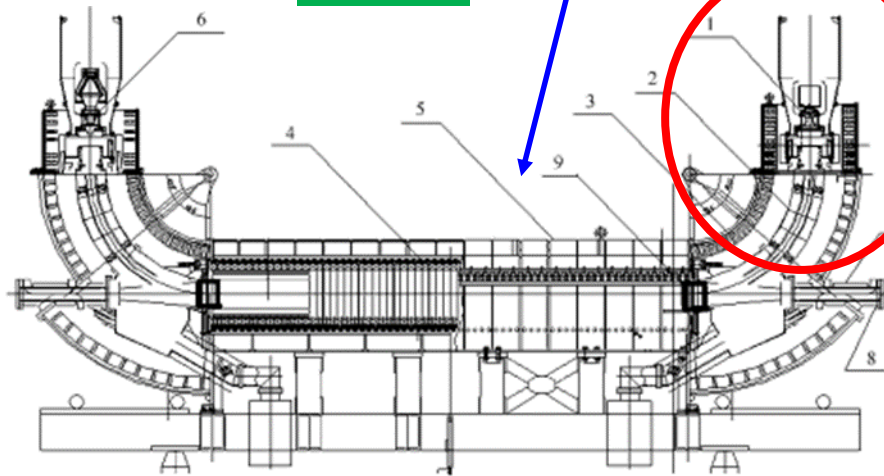
The Bunched Beam Cooling Experiment Setup

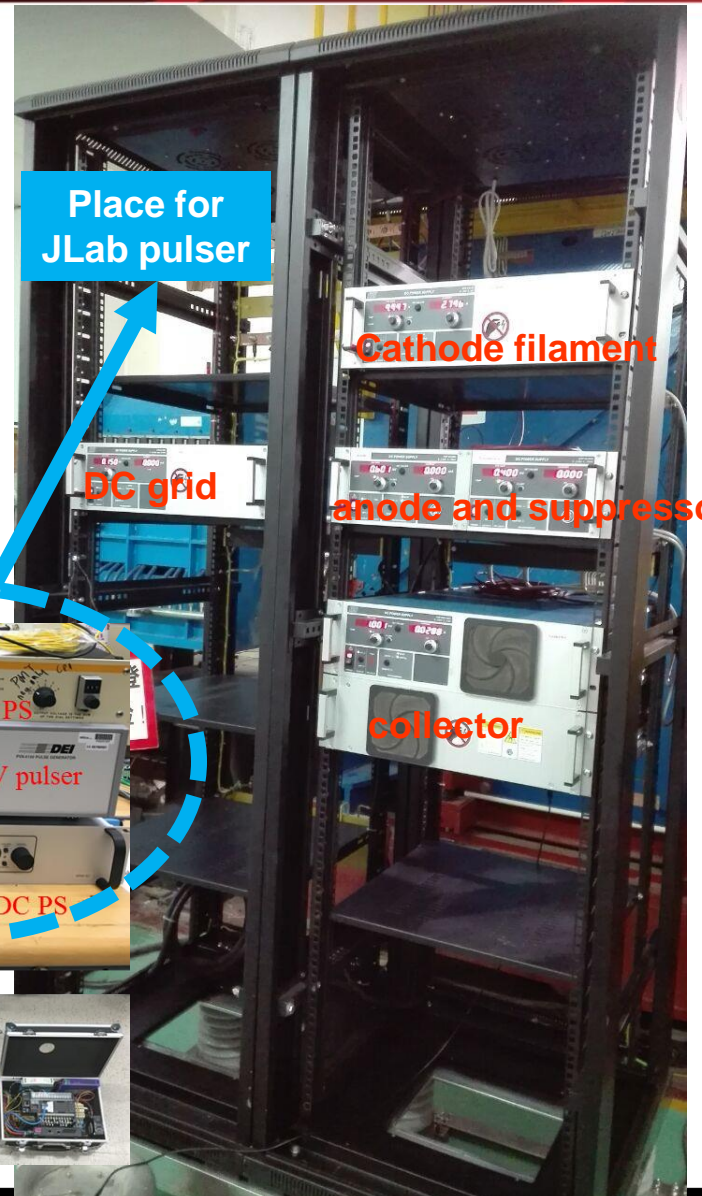
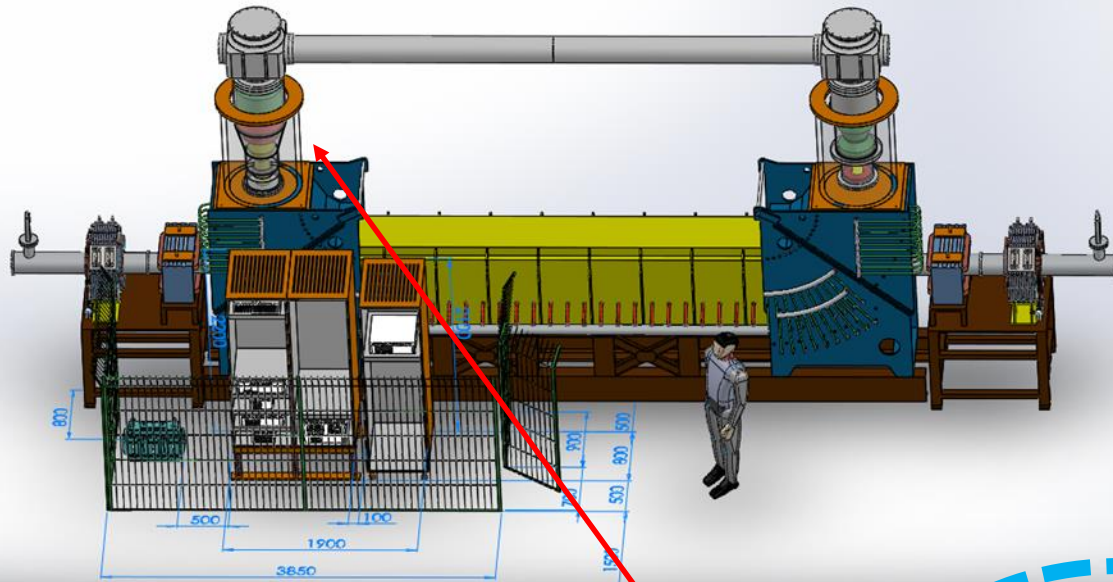

>95% beam transmission

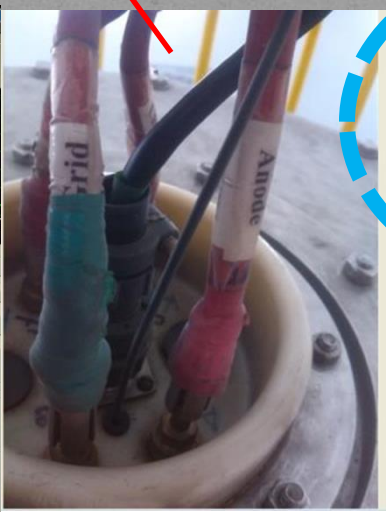

Observation of Cooling of Bunched Ion Beam by a Pulsed Electron Beam

Experiment data observation on BPMs

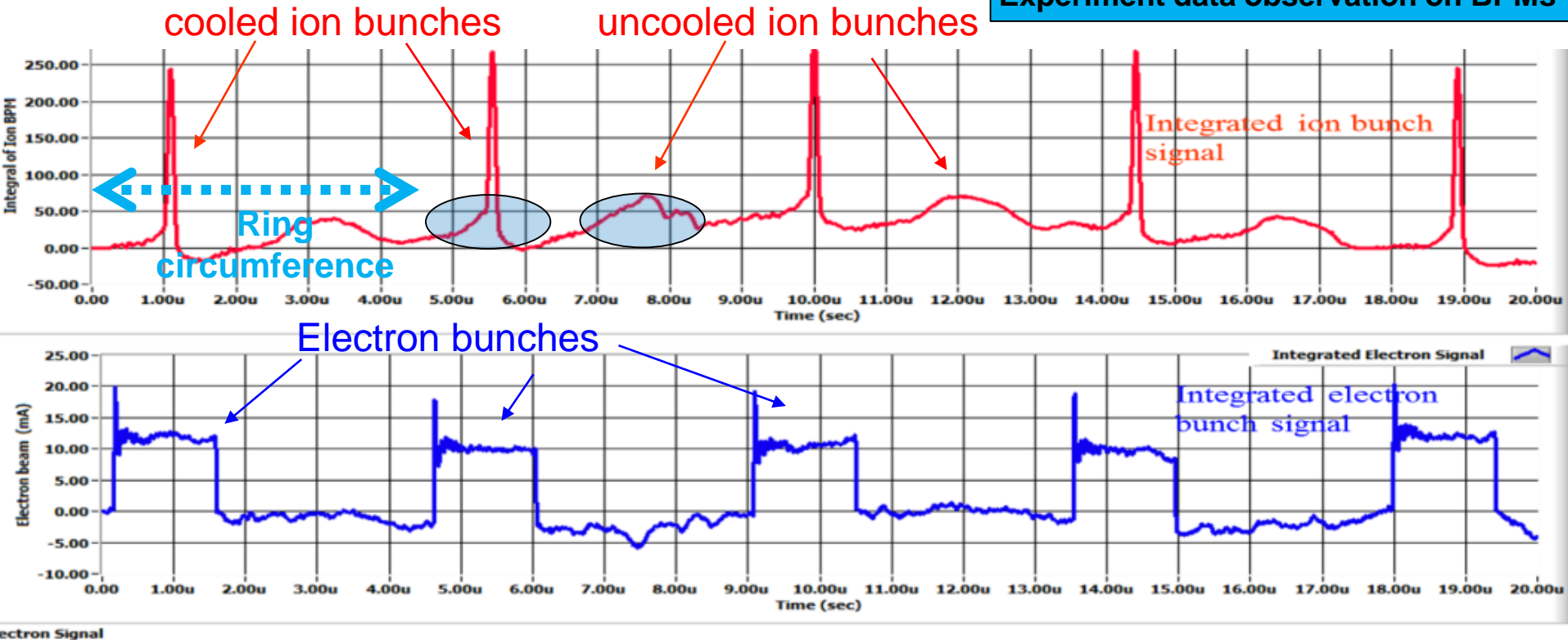

- ❖ Two long ion bunches in the ring, only one of them was cooled
- ❖ After cooling, the cooled ions has a much smaller energy spread, then the ions were more concentrated around center of the RF bucket

A Closed Look of Pulsed Beam Cooling

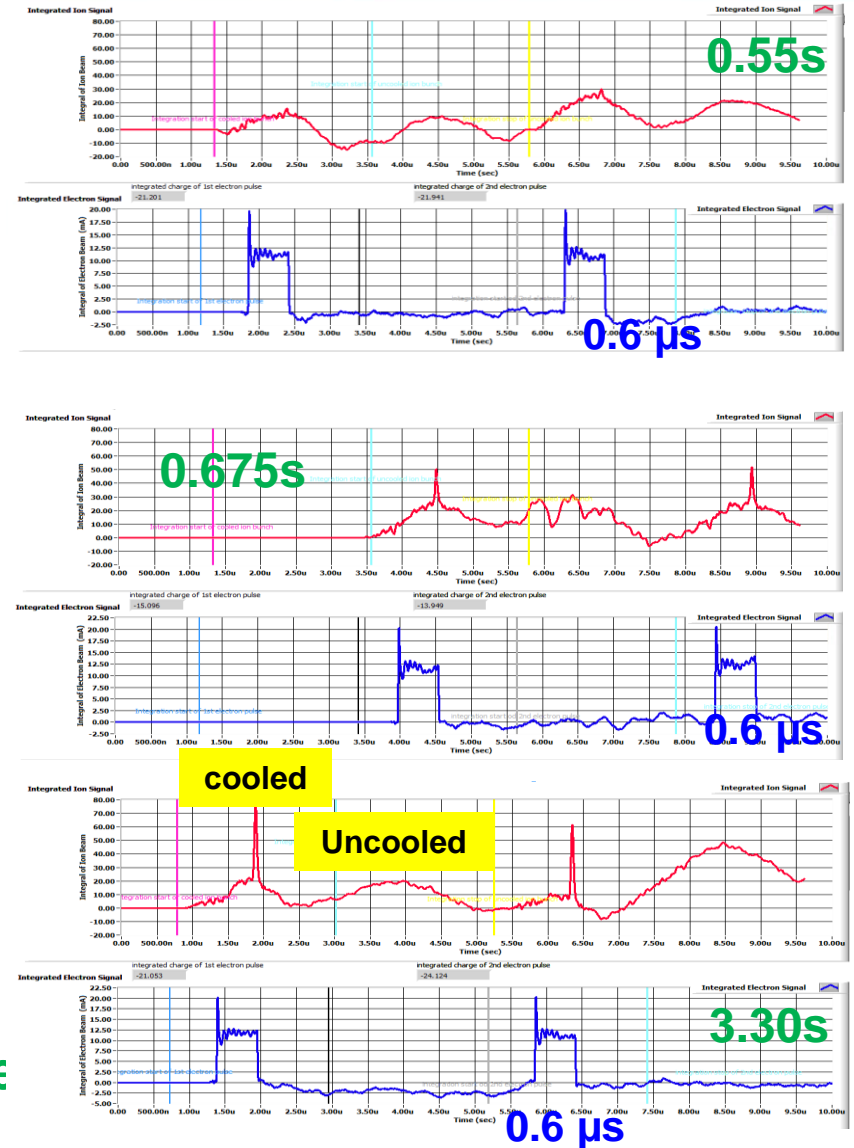
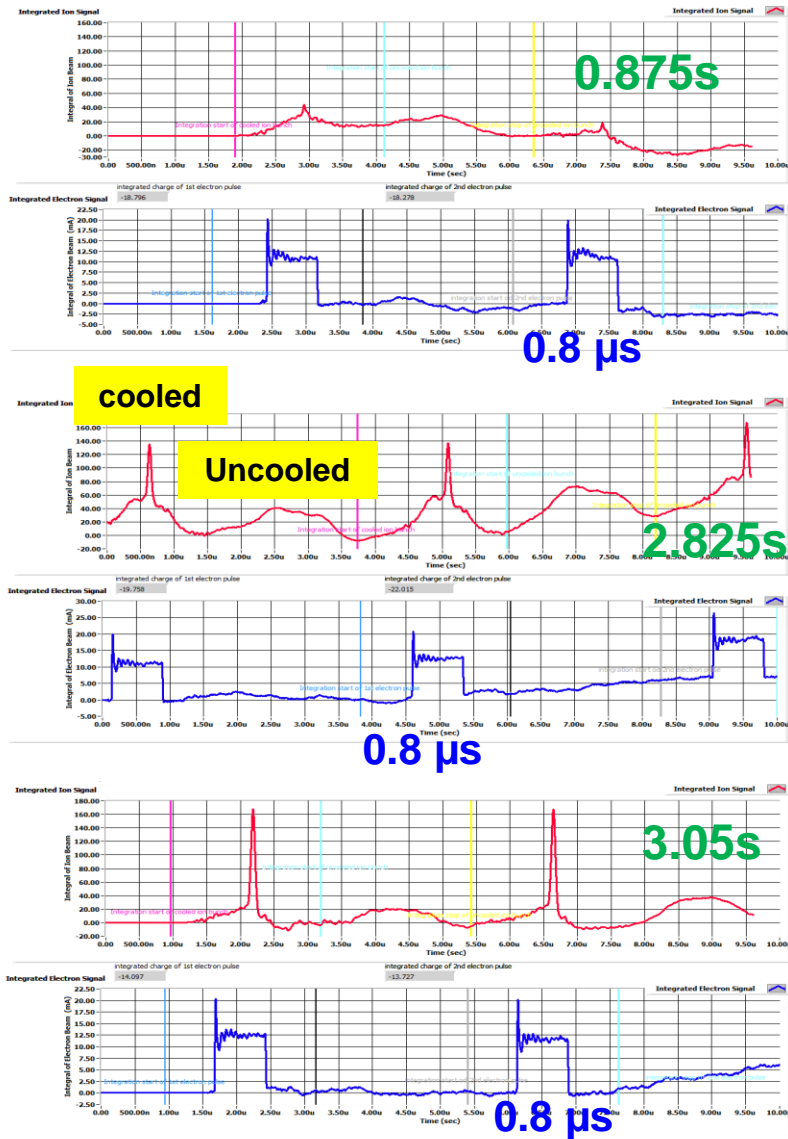

time

Observation of Cooling of Coasting Beam By A Very Short Pulsed Electron Beam

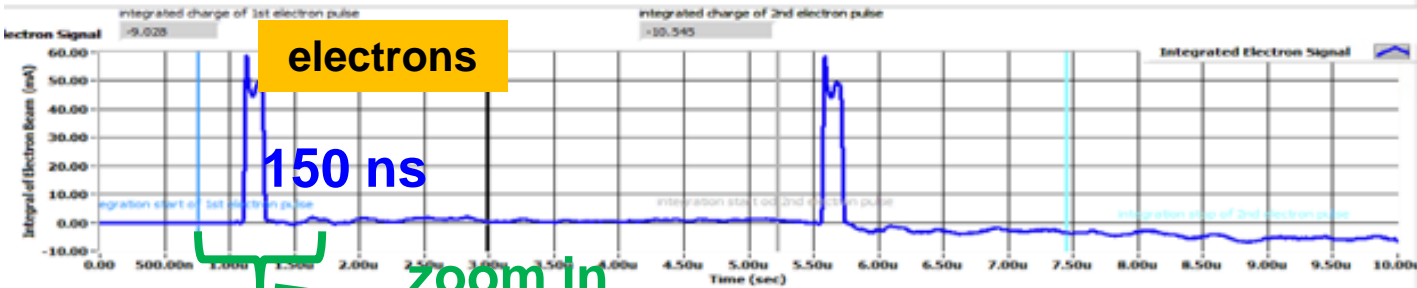
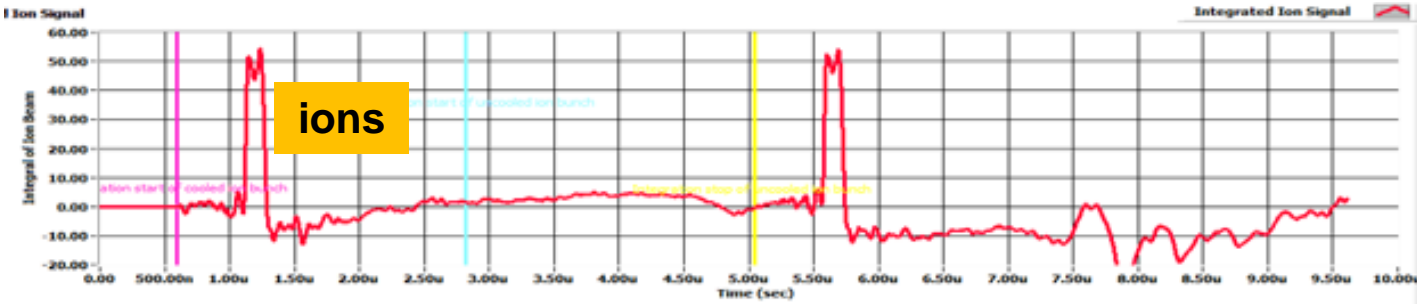

zoom in

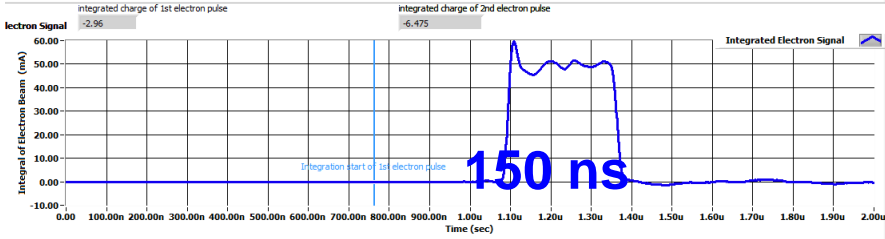
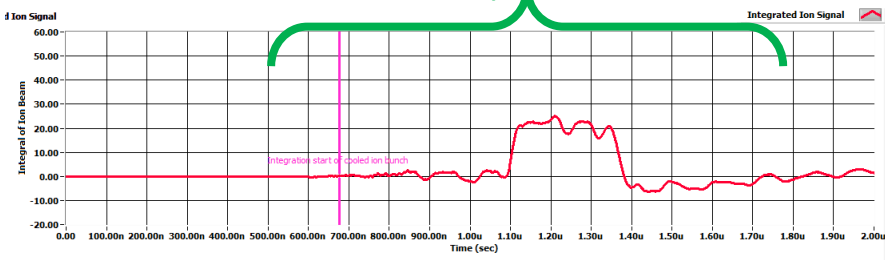

- Beam synchronization between electron pulse and ion bunch is critical
- Both electron and cooled ion have the same bunch length ~ 150 ns
- Without fine tune the electron pulser's frequency with the ion revolution frequency, the cooling effect can be lost

High Polarization with A Figure-8 Topology

All ion rings (booster & collider) have a figure-8 shape

- Spin precessions in the left & right parts of the ring are exactly cancelled
- Net spin precession (*spin tune*) is zero, thus energy independent

Advantage 1: Ion spin preservation during acceleration

- Ensures spin preservation
- Avoids energy-dependent spin sensitivity for ion all species
- Promises a high polarization for all light ion beams

Advantage 2: Ease of spin manipulation

- Delivering desired polarization at multiple collision points

Advantage 3: The only practical way to accommodate polarized deuterons (ultra small $g-2$)

(The electron ring has a similar shape since it shares a tunnel with the ion ring)

Ion Spin Motion in a Figure-8 Ring

- **The team**

- A. Kondratenko, M. Kondratenko (Sci. Tec Lab, Zaryad), Y. Filatov (Moscow IST)
- Ya. Derbenev, F. Lin, V. Morozov (Jlab)

- **Properties of a figure-8 structure**

- Spin precessions in the two arcs are exactly cancelled
- The spin tune is zero independent of energy

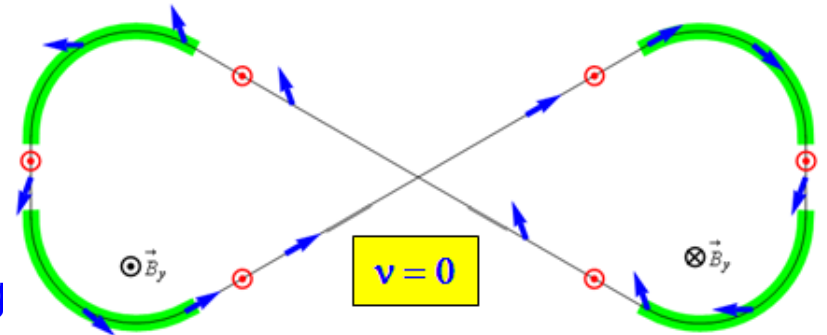

- **Design of polarization in ion booster ring and collider ring, a figure-8 ring provides unique capabilities for polarization control**

- It allows for stabilization and control of the polarization by small field integrals
- Spin rotators are compact, easily ramp-able and give no orbit distortion
- It eliminates depolarization problem during acceleration
- It provides efficient polarization control of any particles including deuterons
- It is currently the only practical way to accommodate polarized deuterons
- It allows for a spin flipping system with a spin reversal time of ~ 1 s

Spin Dynamics in Ion Booster

- Acceleration in figure-8 booster with transverse quadrupole misalignments
- 0.3 Tm (maximum) spin stabilizing solenoid

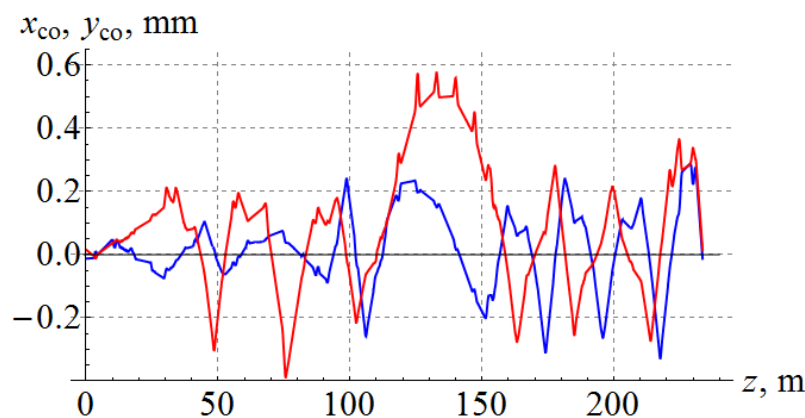
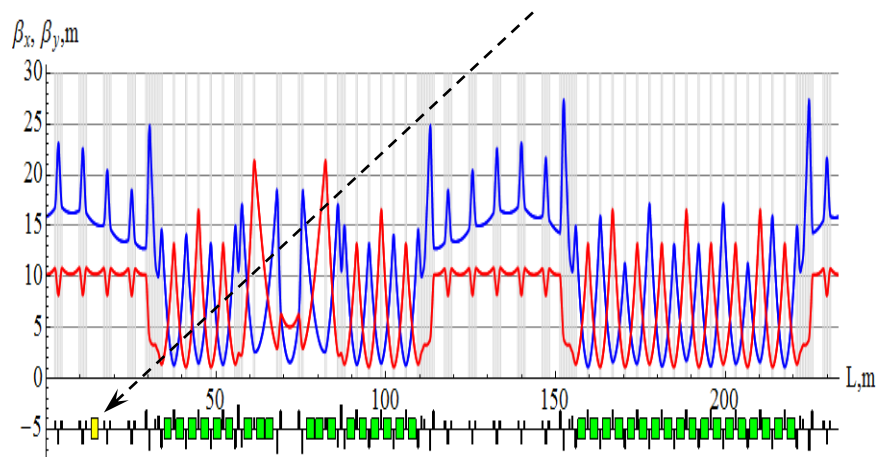

- Spin tracking simulation using Zgoubi (developed by F. Meot, BNL)

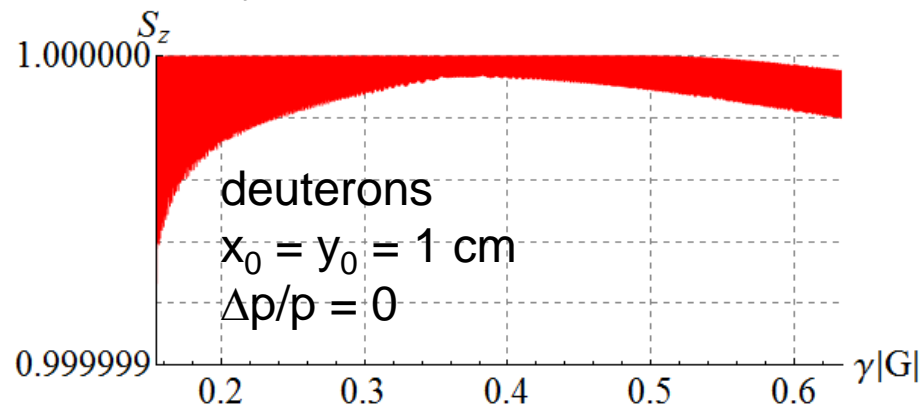
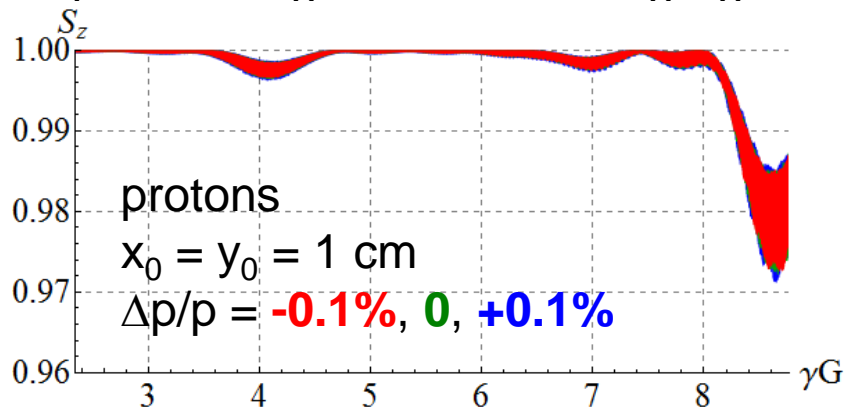

Polarization Control in Ion Collider Ring

- **3D spin rotator:** control of the radial, vertical, and longitudinal spin components
- Module for control of the radial component (fixed radial orbit bump)

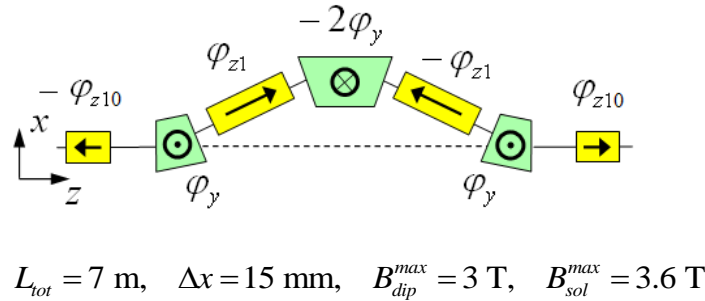

- Module for control of the vertical component (fixed vertical orbit bump)

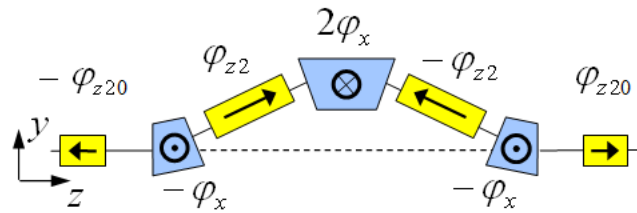

- Module for control of the longitudinal component

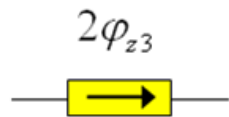

$L_x = L_y = 0.6 \text{ m}, \quad L_{zi} = 2 \text{ m}, \quad L_{zi0} = 1 \text{ m}, \quad \alpha_{orb} = 0.31^\circ$

3D spin rotator

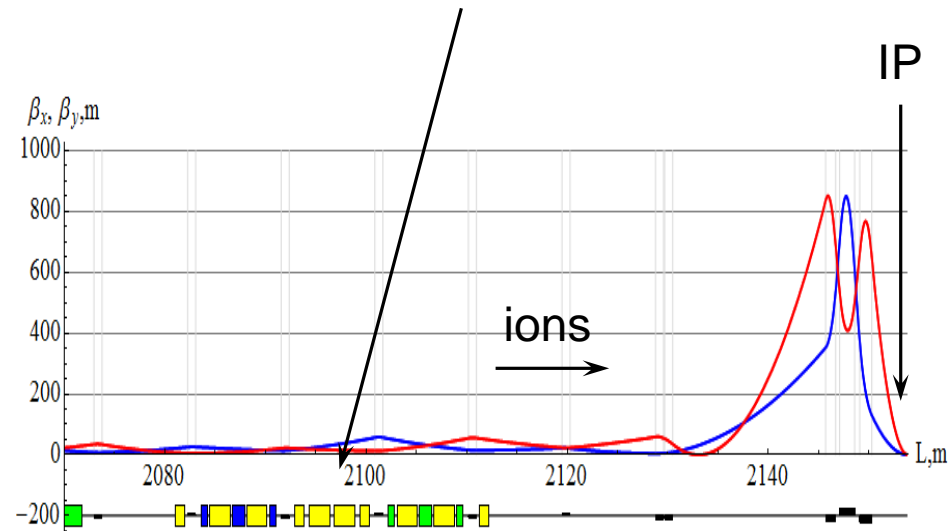
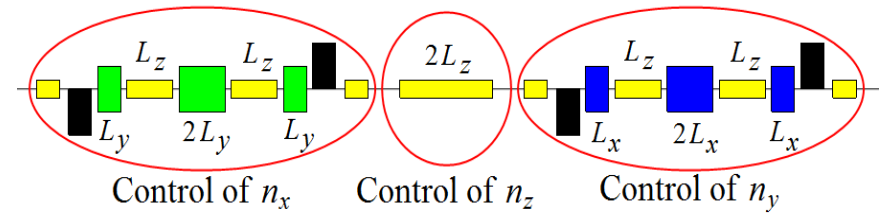

Spin Dynamics in Ion Collider Ring

- 100 GeV/c figure-8 ion collider ring with transverse quadrupole misalignments

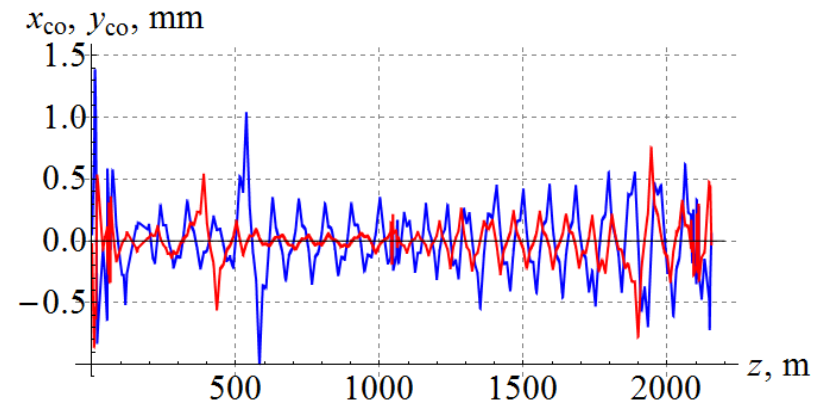
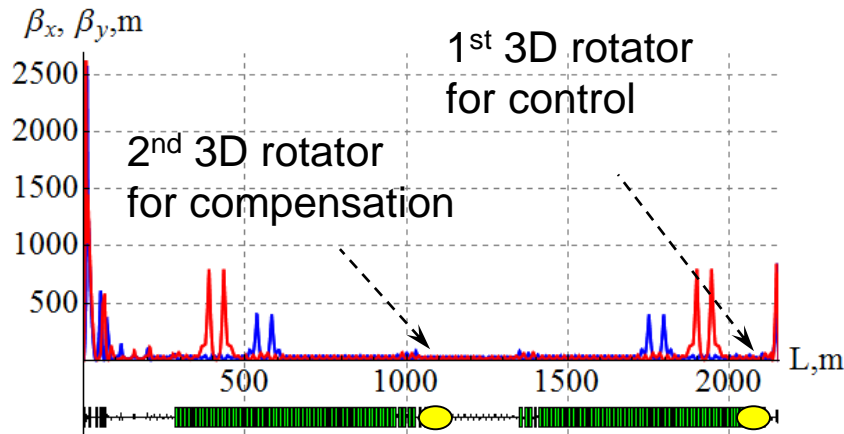

- Example of vertical proton polarization at IP. The 1st 3D rotator: $\nu = 10^{-2}$, $n_y=1$. The 2nd 3D rotator is used for compensation of coherent part of the zero-integer spin resonance strength

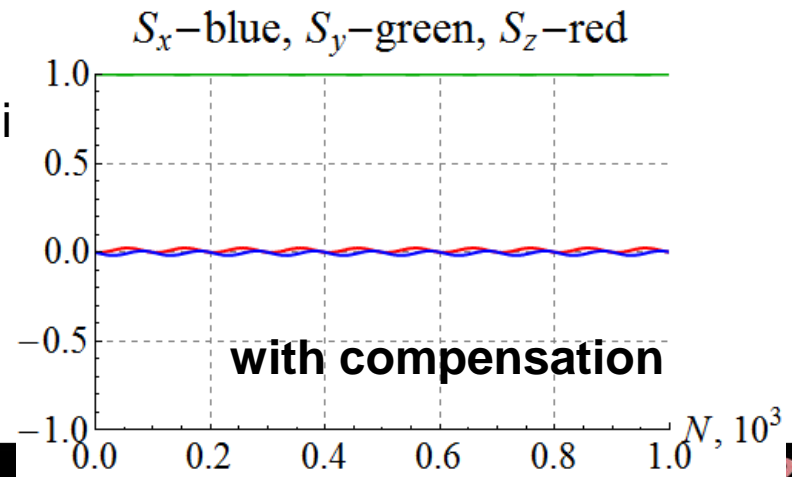
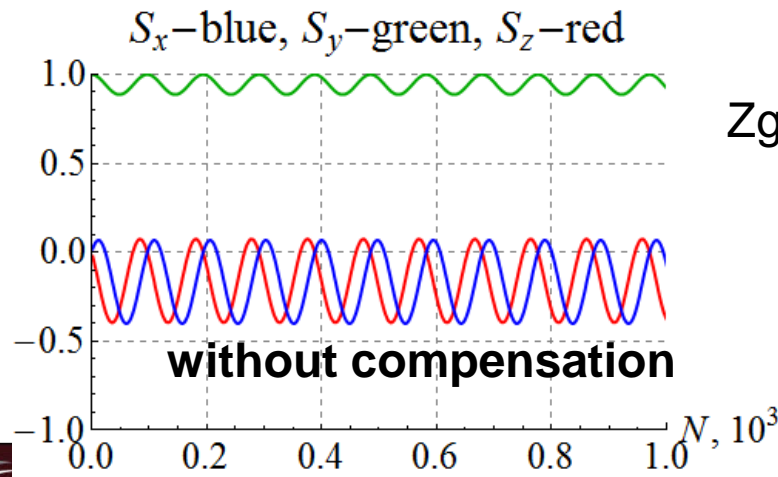

Summary and Future Work in Ion Polarization

- **Schemes have been developed for the figure-8 design**
 - eliminate resonant depolarization problem during acceleration
 - allow polarization control by small fields without orbit perturbation
 - provide for seamless integration of the polarization control into the ring lattice
 - efficiently control the polarization of any particles including deuterons
 - allow adjustment of any polarization at any orbital location
 - allow spin manipulation during experiments
 - make possible ultra-high precision experiments with polarized beams
 - allow for straightforward adjustment of spin dynamics for any experimental needs
- **Initial spin tracking results support the validity of the concepts**
- **Future work**
 - Spin tracking to validate the statistical model and verify developed schemes
 - Development of efficient numerical techniques for spin calculations
 - Optimization of response function at the IP by tuning the lattice
 - Spin flipping development

Nonlinear Beam Dynamics Studies

• The issue

- Due to very low- β^* (for achieving high luminosity), the Interaction Region is characterized by very high β -functions in the final focus quadrupoles.
- The latter cause energy dependent betatron tune and beta functions.
- This creates a large non-linear tune chromaticity and chromatic beam size and may significantly reduce the energy dependent dynamic aperture.

• The solution

- A local Chromaticity Compensation Block (CCB) using sextupoles
- The CCB must also compensate the non-linear geometric (amplitude dependent) aberrations created by the sextupoles.
- Three CCB options based on -1 sextupole pairs (using local non-interleaved and distributed interleaved -1 pairs) were implemented

• The team (*JLab-SLAC collaboration*)

- F. Lin, V. Morozov, G. Wei (JLab)
- Y. Nosochkov, M-H. Wang (SLAC)

**M. Sullivan
presentation**

Lattice Design & Compensation Schemes

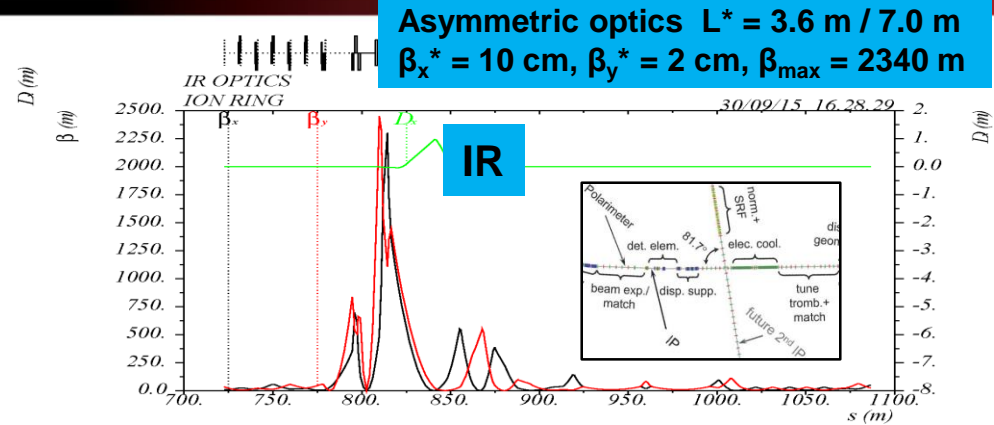
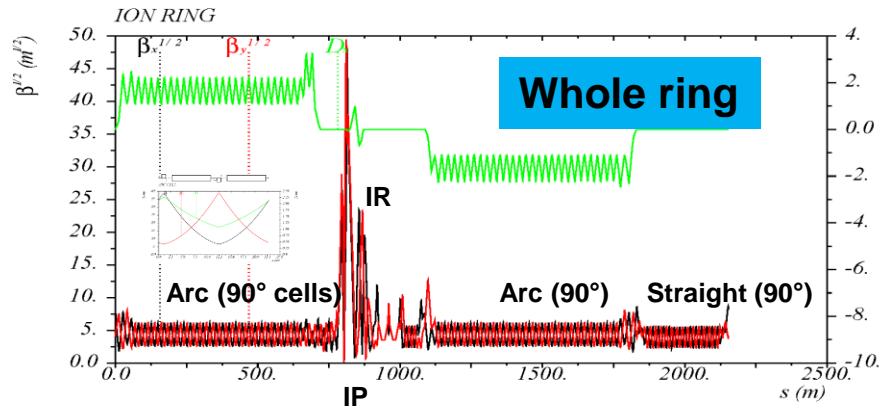

- Advantage: sextupole non-linear geometric effects in a $-l$ pair are self-compensated
- The $-l$ sextupoles can be implemented using pairs of 90° arc cells.
- Two family sextupoles in the other arc cells compensate linear chromaticity

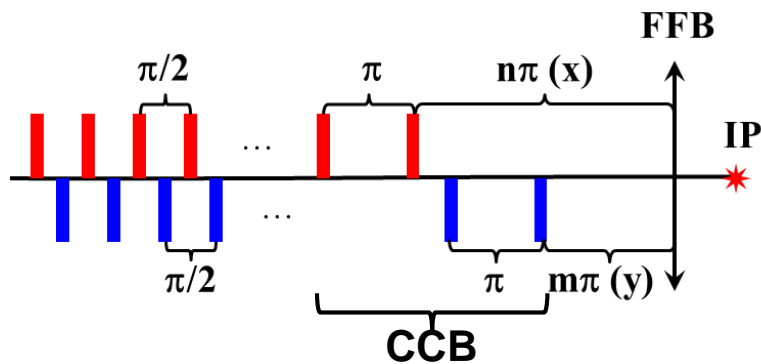

Scheme 1: two *non-interleaved* $-l$ pairs (cancellation of geometric effects)

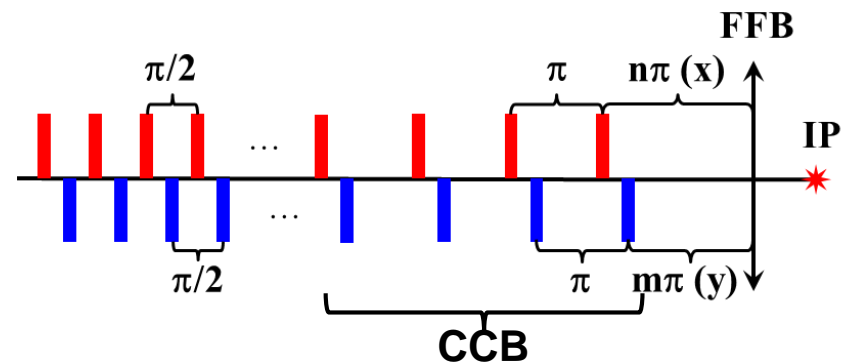

Schemes 2,3: *Distributed interleaved* $-l$ pairs (some residual geometric effects)

SR Background at IR and Other Places

M. Sullivan presentation

- The work is done by M. Sullivan (SLAC)
- Several background sources that need to be studied
- Backgrounds can change as the IR design evolves

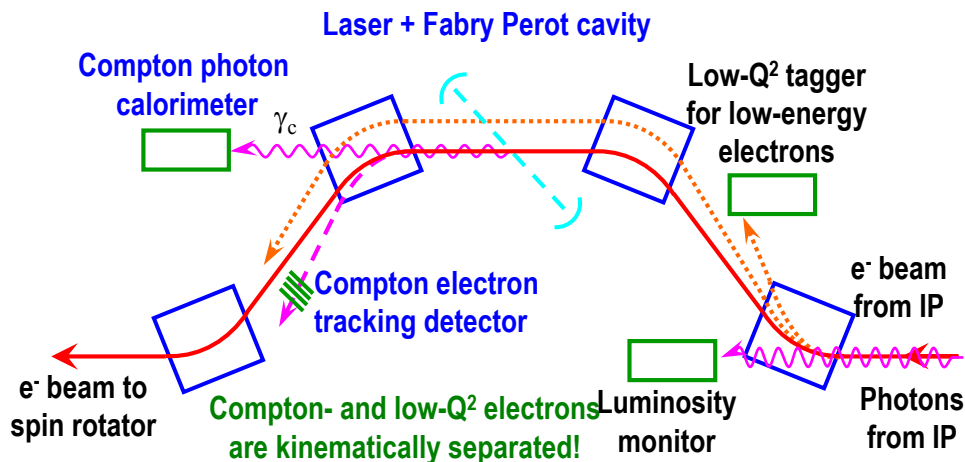

Photons/crossing >10 keV

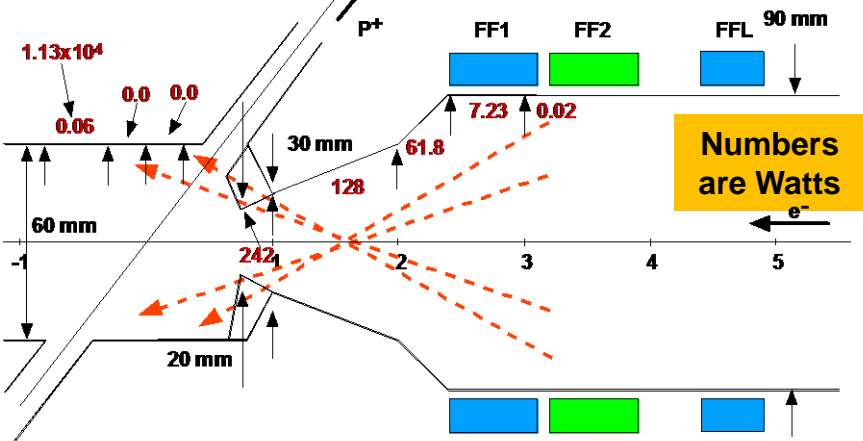

Beam pipe design fits 10σ beam envelope. Prefer larger.

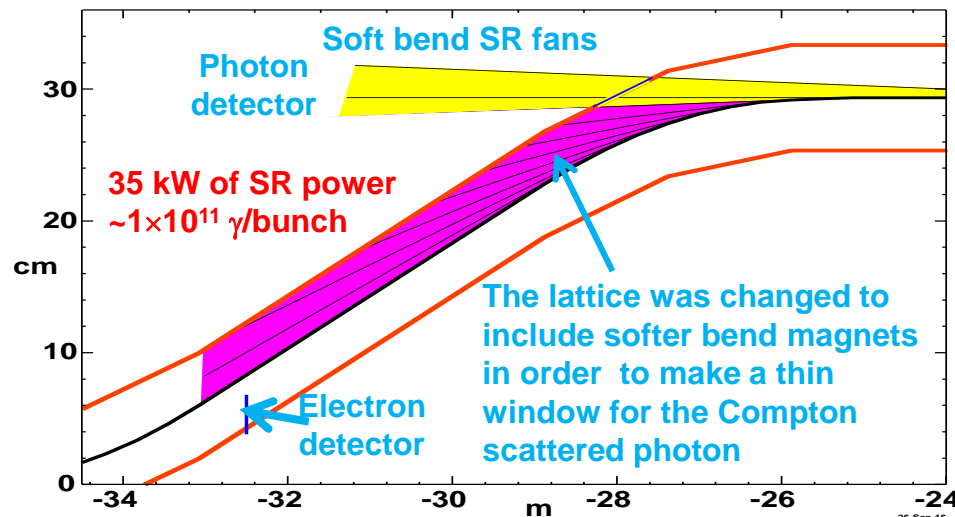

26-Sep-16
M. Sullivan

JLEIC RF System R&D

- **The present RF design (down-selection of frequency/technology)**
 - Electron collider ring: reuse of PEP-II warm RF (frequency 476 MHz)
 - Proven technology, enough cavities and klystrons available
 - 476.3 MHz buckets can be filled from CEBAF linac with simple timing system
 - Ion collider ring: new SRF systems
 - RF frequency is 952.6 MHz (future upgrade consideration)
 - Crab cavity system also has a 952.6 MHz frequency
 - Cooler source and ERL now 952.6 MHz (?)
 - Ion injector chain frequency not affected
- **The team**
 - Led by R. Rimmer, with J. Guo, H. Wang, S. Wang
 - J. Delyean (ODU) on crab cavity

Ion Ring SRF Cavity Design Concept

- 952.6 MHz SRF HOM damped 1-cell cavities, modular Jlab cryomodule
- High frequency/high voltage for short bunch (re-bucket at energy)
- **Medium-power couplers** , no synch. rad. Power.
- Tunable within one harmonic (harmonic jumps for path length changes with energy)
- Impedance is a concern so HOM damping is still needed.
- Multi-cell cavity may be needed for higher energies (upgrades)

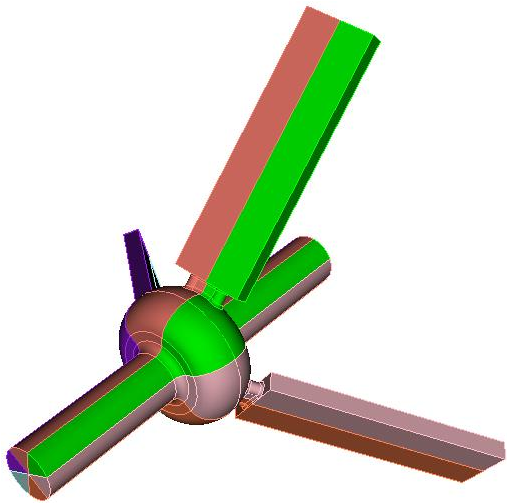

On-cell HOM damped cavity concept

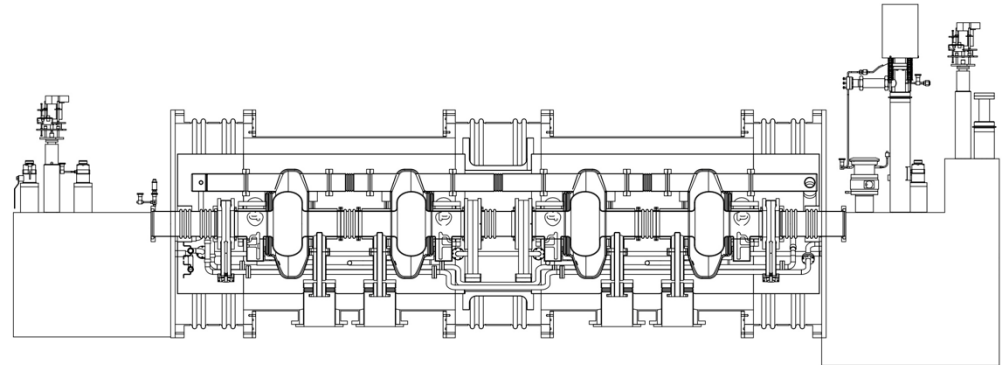
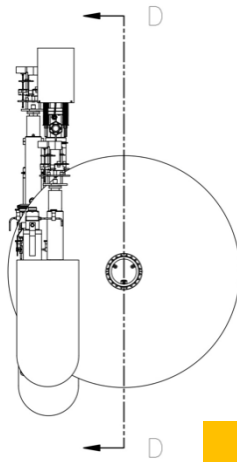

952.6 MHz single cell 4-seater CM
(~4.3m flange to flange. Waveguide HOMs not shown)

“Strong” bunched-beam Cooling

- Electrons circulate 10 to 30 turns in **circulator ring**, fed by an **ERL**
- Beam current and bunch repetition frequency reduced by a factor of 10 to 30
- **Fast kickers (FK)** needed with rise and fall-off times of a fraction of a ns

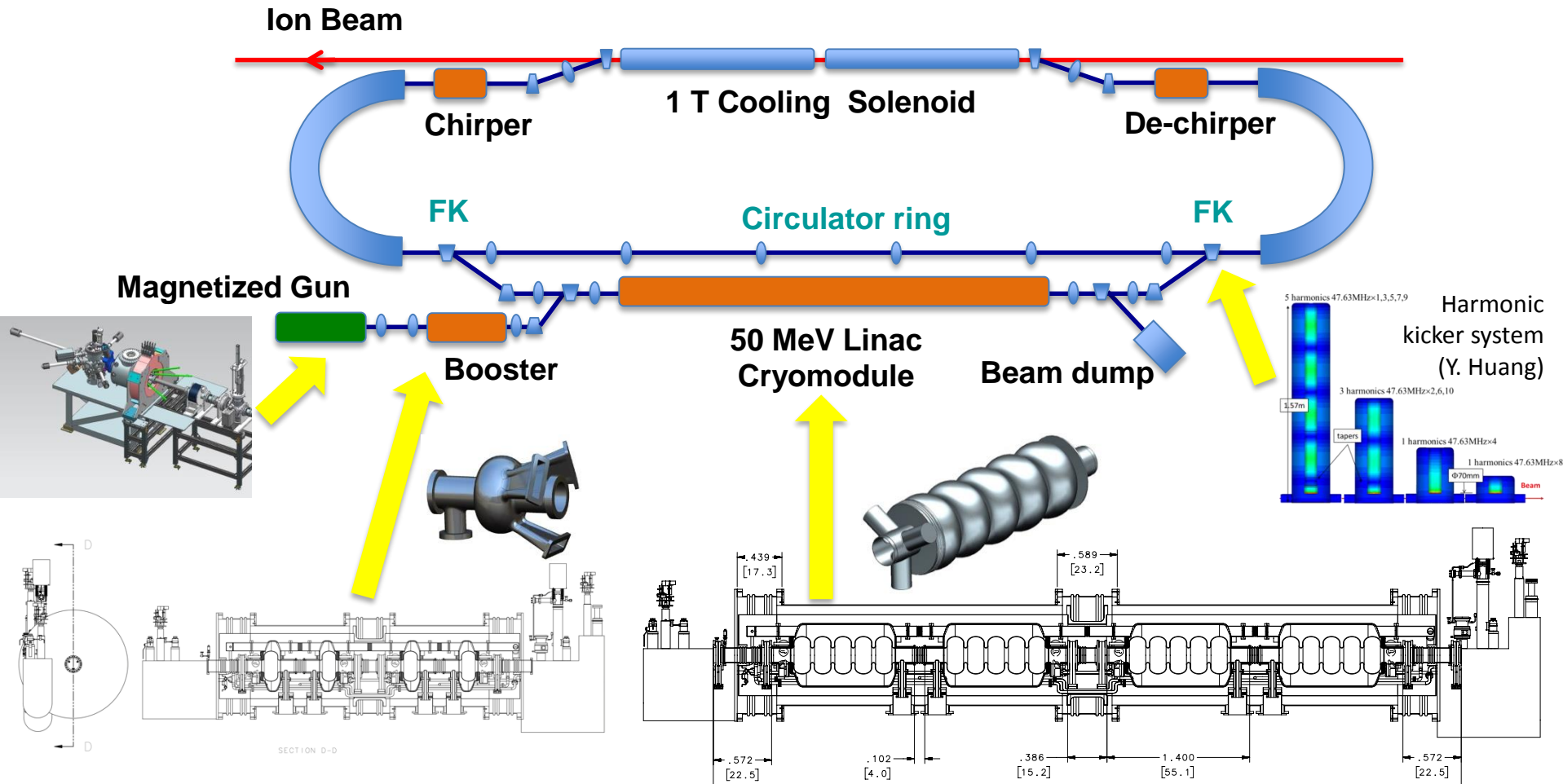

952.6 MHz Cavity Prototype

- Cell RF design is complete
- Preliminary engineering analysis is complete
- Cell dies have been fabricated
- Test blanks have been pressed
- Beam tube dies have been fabricated (110 mm)
- **End group design** will be chosen based on simulation results
 - Impedance requirements (Q spec)
 - HOM power (i-ring, e-ring, ERL)
- Will produce single-cell first (possibly using ingot material)

J. Henry

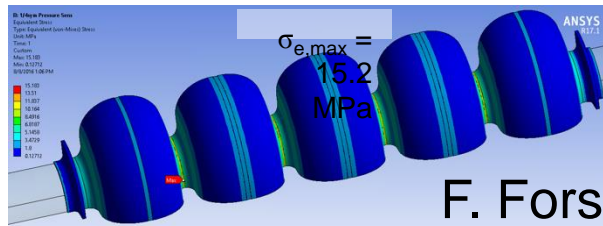

L. Turlington

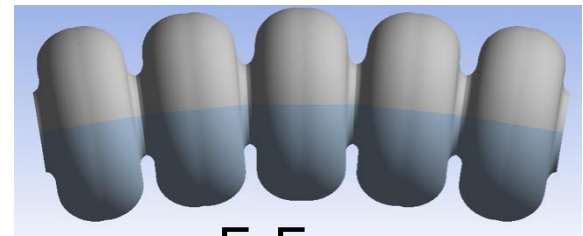
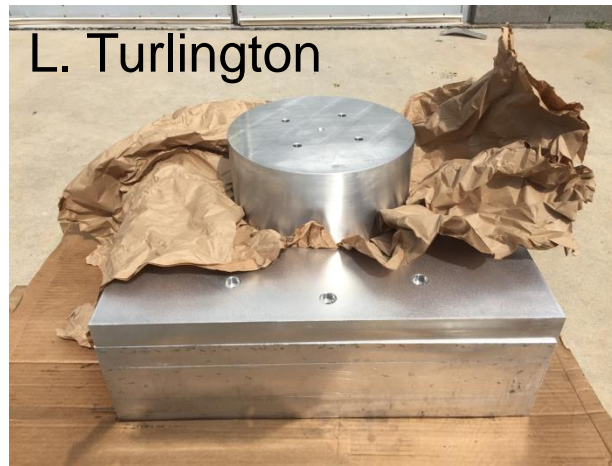

F. Fors

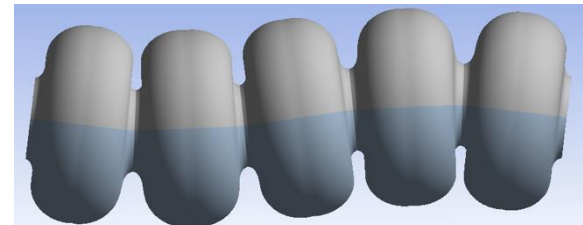

Modular Cryostat

- Take the best features of previous JLab designs
- Modular approach to hold various different cavities
- Design suitable for industrial production
- Simple concepts, low parts count to reduce costs

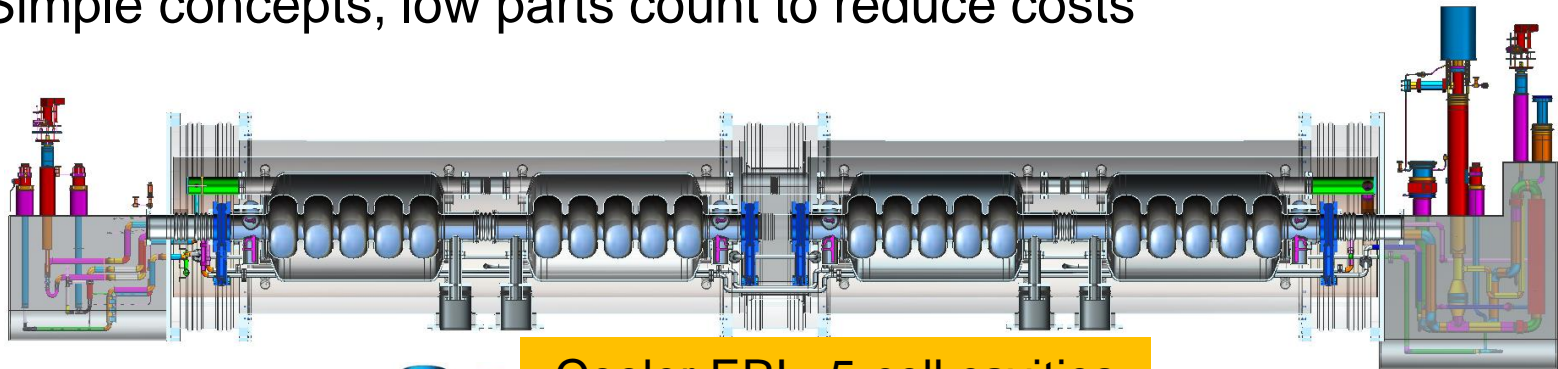

Cooler ERL, 5-cell cavities

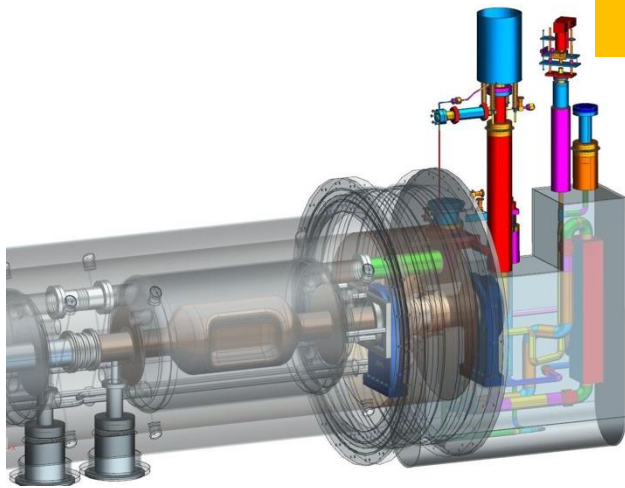

476.3 or 952.6 MHz Crab cavity

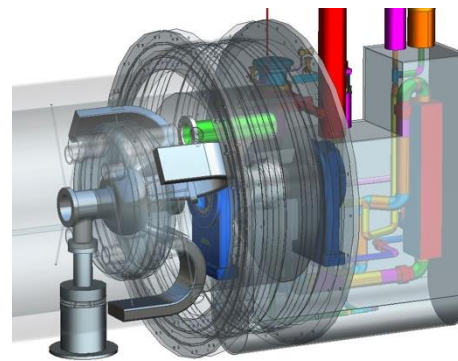

952.6 MHz on-cell damper concept

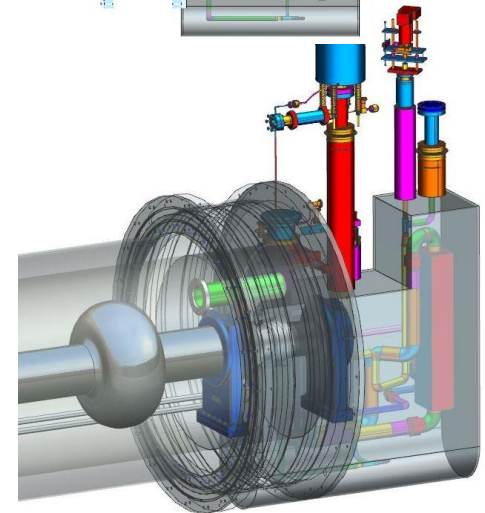

476.3 MHz 1-cell?

Conclusions for RF System R&D

- 952.6 MHz cavity cell shape has been finalized
- HOM damping schemes for i-ring and cooler are being evaluated (also for e-ring)
- Cell and beam pipe dies have been fabricated
- Pressing of test pieces underway
- HOM damping down select will be made based on beam stability conditions, HOM power spectrum
- “modular” cryostat can accommodate all options

Super-Ferric Magnet Development

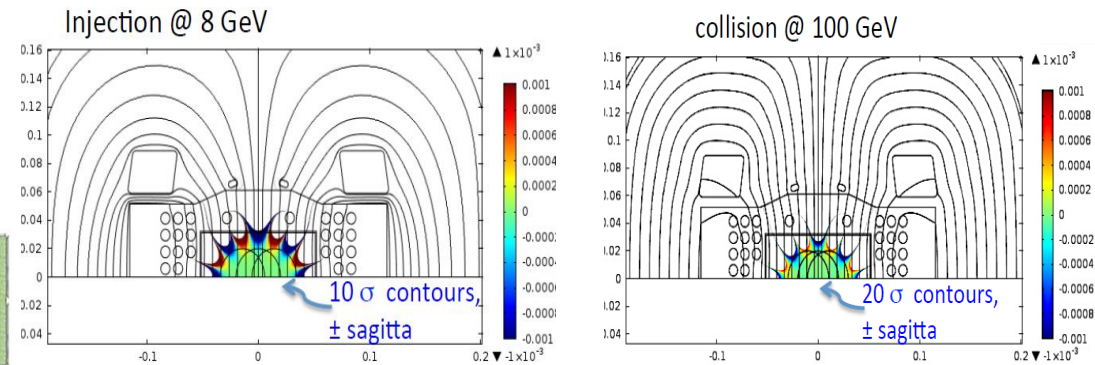
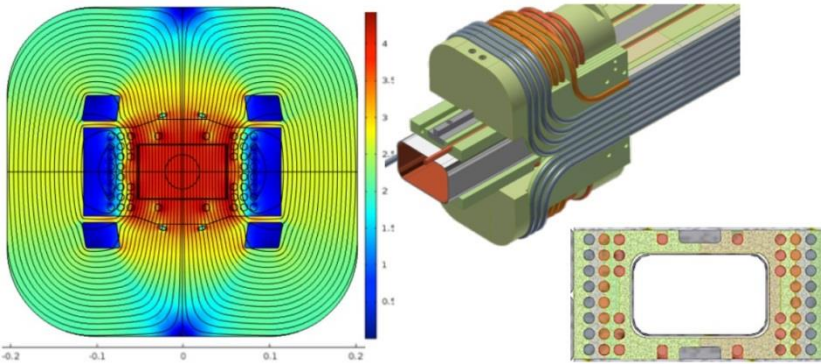
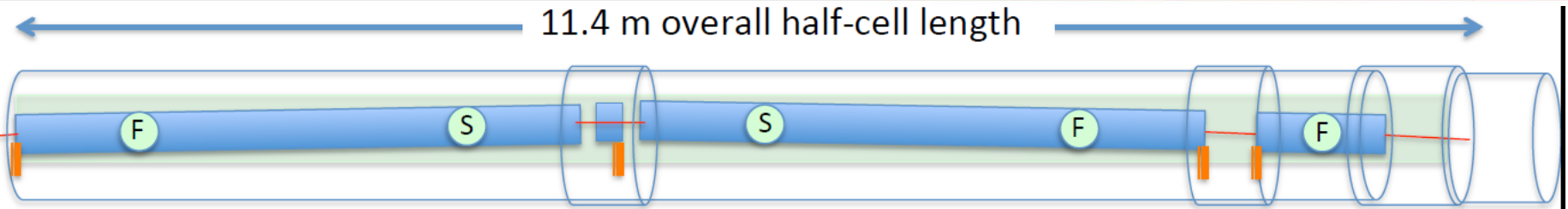

- Prepare CDR for Ion Ring dipole. ✓
- Fabricate mock-up winding to evaluate fabrication method, precision of location of windings in body and ends.
- Design/build 1.2 m prototype of 3 T super-ferric dipole

**P. McIntyre
presentation**

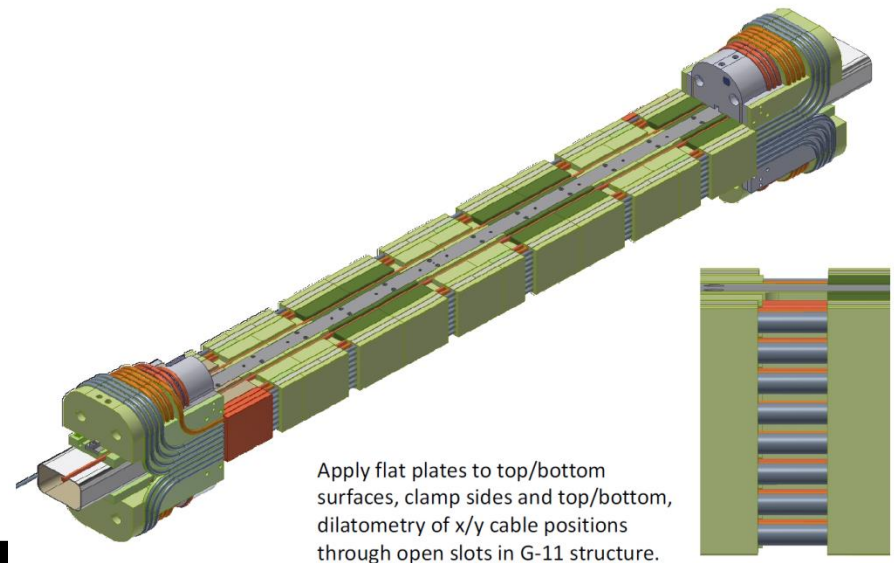

Design Optimization of JLEIC Ion Linac

B. Mustapha presentation

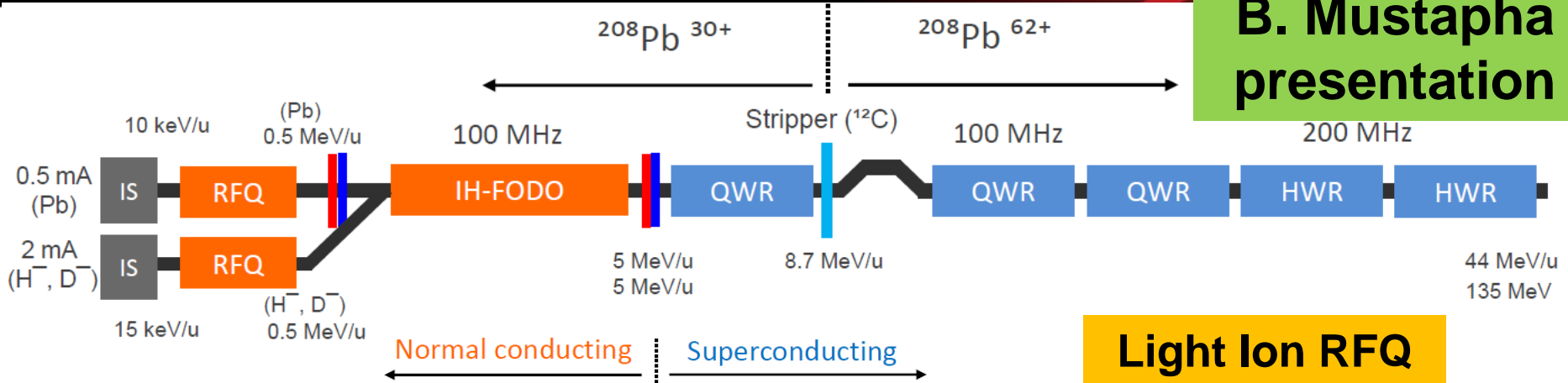

Light Ion RFQ

0.015 – 0.5 MeV/u
 $f = 100$ MHz
 $Q = 9700$
 $V = 103.4$ kV
 $P = 113$ kW
 $L = 2$ m

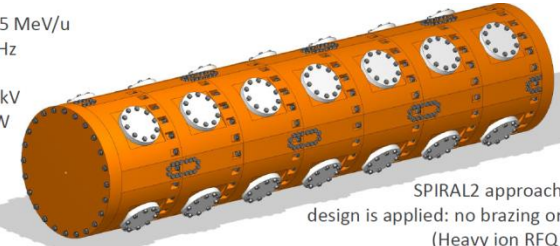

SPIRAL2 approach to mechanical design is applied: no brazing or welding joints (Heavy ion RFQ can be similar)

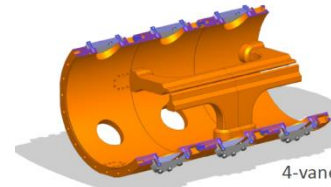

One RFQ segment, 40 cm diameter

4-vane with magnetic coupling windows: Compact & Suitable for pulsed mode

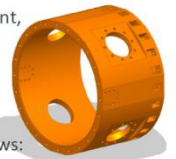

SRF linac section

QWR Design

HWR Design

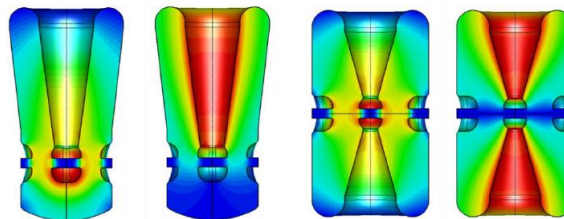

QWR Module



HWR Module



Horizontal orientation of cavities

- Recent Updates to the Ion Linac Design
 - Two RFQs: One for light ions & one for heavy ions
 - IH-DTL: No frequency jump & FODO lattice instead of triplets
 - Two LEBTs designed for light & heavy ion beams
- Design of Different Linac Sections
 - LEBTs
 - RFQs
 - IH-FODO
 - SRF Linac

Outline

- Introduction
- Update on Accelerator Design
- The DOE-ONP Supported R&D and Budget
- Description of Projects
- **Perspective of Future Accelerator R&D**
- Outlook and Summary

EIC Accelerator R&D List

- Development/proof-of-principle of **Electron cooling** for ion beam energy up to 100 GeV (including both DC cooler and bunched beam ERL cooler)
- Development and proto-type of **super-ferric magnets** (up to 3 T, good field region and fast ramping) (*relatively new task*)
- Development/proof-of-principle of **ion beam formation** scheme (for many small short bunches)
- Design & numerically demonstration of high **beam polarization** in a **figure-8** ring
- Design/proto-typing of **SRF system** for a storage ring with requirements of supporting high accelerating field, high RF power & high frequency
- Development of SRF **crab cavity**
- Development of mitigation scheme for **beam synchronization**

Additional Issues in Design Studies

- Development/optimization of chromatic compensation scheme and study of dynamic aperture
- Development/optimization of interaction region design & its integration of a full-acceptance detector (*better for physics, less trouble to beam transport*)
- Optimization of design of the electron collider ring which reuses the PEP-II magnets, particularly, achieving small equilibrium emittance
- Development of Integration of crab cavities in the interaction region
- Studies of nonlinear beam dynamics and collective effects in two collider rings and in the ion injector complex (linac and booster)
- Exploring engineering solutions for implementing beam synchronization scheme

Summary

- **The DOE-ONP support we have received enabled us to perform a few critical design studies and accelerator R&D.**
- **Presently the JLab team is planning the pre-CDR**
 - Continuing design optimization (primarily for retiring remaining technical risks/uncertainties and reduction of cost)
 - Expanding external collaborations (for example, DC cooler by BINP)
- **There are still R&D before the CDR, the highest priority items are**
 - Development of ERL Bunched beam electron cooler
 - Development of a technical design of a DC cooler
 - Optimizing/finalizing the ion injector design and ion beam formation scheme
 - Proof of key technologies (super-ferric magnets, storage ring SRF, crab cavity)
 - Critical design studies (beam polarization, dynamic aperture, beam-beam, collective effects)

Acknowledgement: Our Partners

Ion linac/injector: *P. Ostroumov* (ANL)

Super-ferric magnet: *P. McIntyre* (Texas A & M Univ.)

IR/Chromatic Compensation/dynamic aperture: Y. Nosochkov, *M. Sullivan*, M-H. Wang (SLAC)

Ion polarization: A. Kondratenko, M. Kondratenko (Sci. Tec Lab, Zaryad), Y. Filatov (Moscow IST)

Electron polarization: D. Barber (DESY)

Bunched beam electron cooling demo: L. Mao (IMP, China)

SRF crab cavity: J. Delayen (ODU)

Backup Slides

Risk Reduction in Design Evolution

- **Changed from a (high-risky) ERL-design to a ring-ring**
(we concluded this change will almost not affect the luminosity performance since the linac-ring has no advantage with many-small-short-bunches, as a result, we eliminated the biggest technical risk without losing performance)
- **Eliminated a circulator ring in the bunched beam e-cooler**
(this does affect performance, however, is still able to meet science needs)
- **Increased the vertical beta-star from 0.5 cm to 2 cm**
(in order to accommodate change of the detector needs, namely, the magnet-free detector space was increased from +/-2.5 m to 7 m/4.5 m, and a large 50 mrad crab crossing angle was also a must for detection)
- **Reduced bunch repetition rate from 1.5 GHz to ~0.5 GHz**
(in order to reduce challenge of SRF cavity development and cost)

Highlights On Design Optimization

- The JLEIC design concept for high luminosity and high polarization was proposed more than 10 years ago
- The baseline design remained basically the same since 2009

During the six months *before the EIC cost review* (1/2015), significant design optimization was achieved for *performance enhancement, cost reduction, technology risk reduction*

- Reusing of **PEP-II equipment** (magnets, vacuum chamber and RF systems) for the JLEIC electron collider ring
- Adopting cost-efficient **super-ferric magnets** for the JLEIC ion booster ring and collider ring
- Elimination of the full size **large booster ring**
- Adopting a **single-pass** ERL bunched beam cooler without a circulator ring

Science Requirements and Conceptual Design for a Polarized Medium Energy Electron-Ion Collider at Jefferson Lab

2012 Design Report

arXiv:1209.0757

MEIC Design Summary

January 20, 2015

Author List

2015 Design Summary

arXiv:1504.07961

Electron Beam Polarization: Introduction

The Team

- Fanglei Lin (JLab), D. Barber (DESY/Liverpool/Cockcroft)
- Supported by A. Camsonne, D. Gaskell, Y. Derbenev, V. Morozov, P. Nadel-Turonski (JLab)

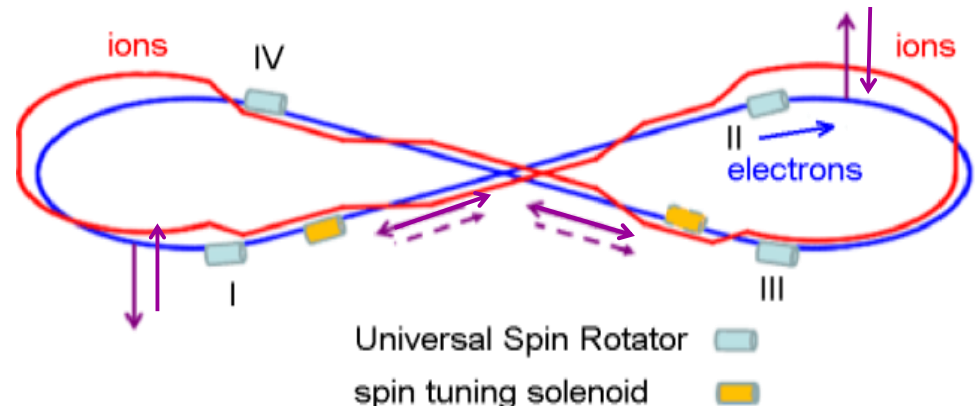

The Design

- Highly polarized e-beam is injected at arc from CEBAF in vertical polarization
 - *avoid spin decoherence, simplify spin transport from CEBAF*
- Polarization is vertical in the arc to avoid spin diffusion and longitudinal at IP
- Universal spin rotator (USR) rotates the polarization near an IP
- Desired spin flipping is implemented by changing the source polarization
- Configuration with figure-8 geometry removes spin tune energy dependence
 - *Significantly suppress the synchrotron sideband resonance*
- Continuous injection of electron bunch trains from the CEBAF is considered to
 - *preserve and/or replenish the electron polarization, especially at higher energies*

Electron Polarization Configuration

- **Unchanged** polarization in two arcs by having **opposite solenoid field** directions in two spin rotators in the same long straight section
 - figure-8 removes spin tune energy dependence, reduces the synchrotron sideband resonances
 - 1st spin perturbation in the solenoids for off-momentum particles vanishes with opposite longitudinal solenoid fields in the pair of spin rotators in the same straight
 - Sokolov-Ternov self-polarization process has a net depolarization effect, but the polarization lifetime is still large with highly-polarized injected electron beams
 - Two polarization states coexist in the collider ring and have the same polarization degradation

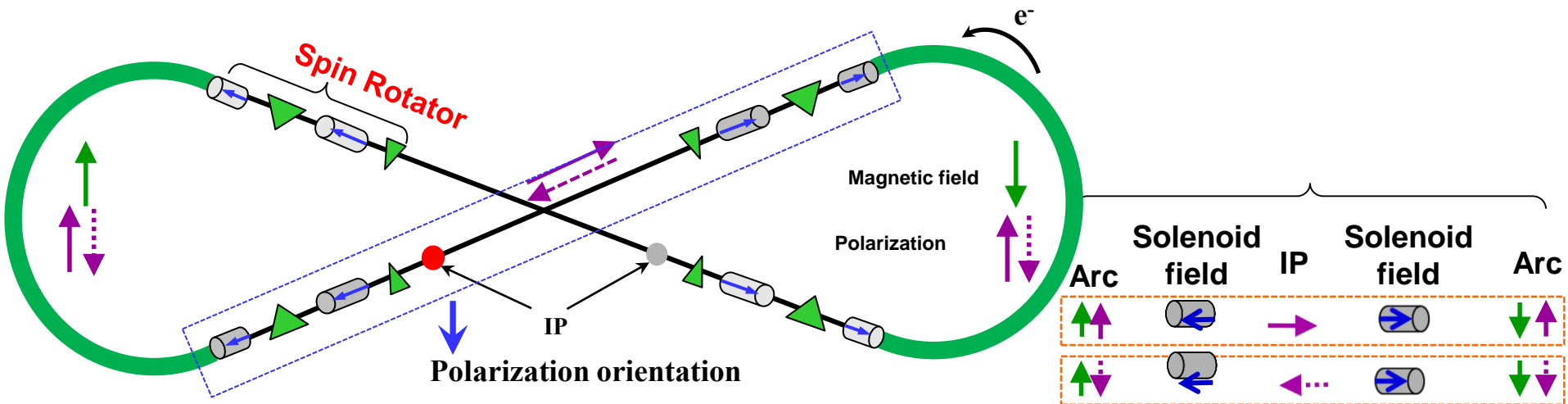

Universal Spin Rotator (USR)

Schematic drawing

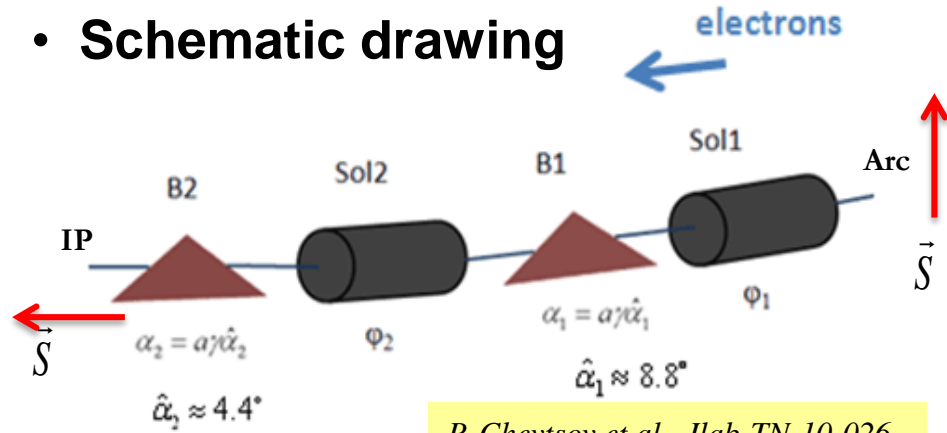

Solenoid decoupling & Lattice function

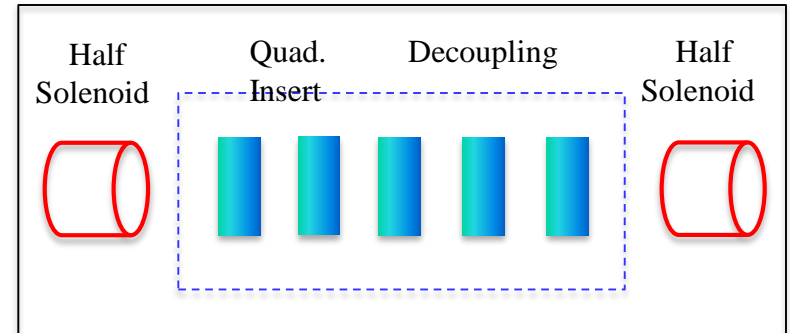

Parameters of USR for MEIC

E	Solenoid 1		Arc Dipole 1	Solenoid 2		Arc Dipole 2
	Spin rotation	BDL	Spin rotation	Spin rotation	BDL	Spin rotation
GeV	rad	T·m	rad	rad	T·m	rad
3	$\pi/2$	15.7	$\pi/3$	0	0	$\pi/6$
4.5	$\pi/4$	11.8	$\pi/2$	$\pi/2$	23.6	$\pi/4$
6	0.62	12.3	$2\pi/3$	1.91	38.2	$\pi/3$
9	$\pi/6$	15.7	π	$2\pi/3$	62.8	$\pi/2$
12	0.62	24.6	$4\pi/3$	1.91	76.4	$2\pi/3$

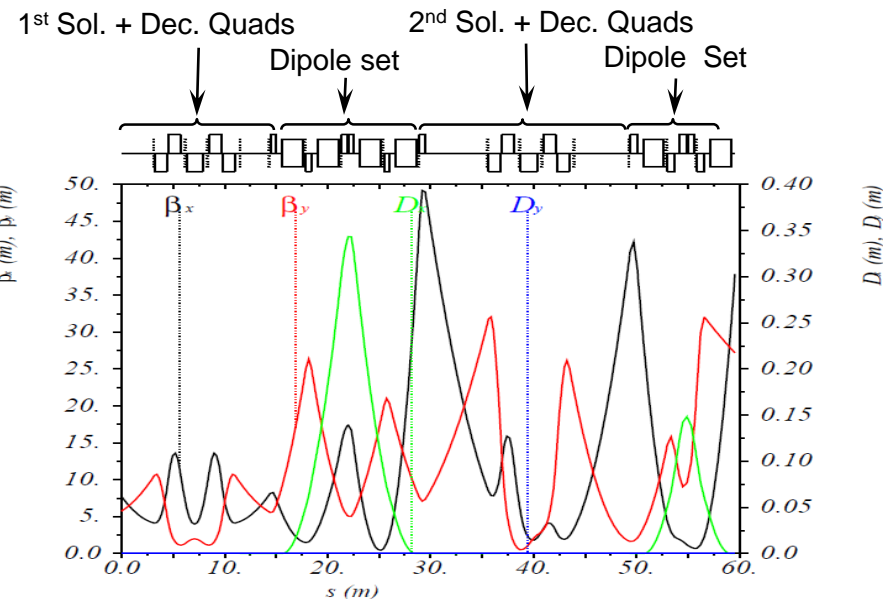

Polarization Simulation and Compensation

• Spin tune scan @ 5 GeV

- Longitudinal field spin tuning solenoid is inserted in the straight where the polarization is longitudinal
- Monte-Carlo simulation
- Main field errors, quads vertical misalignment and dipole role, are introduced

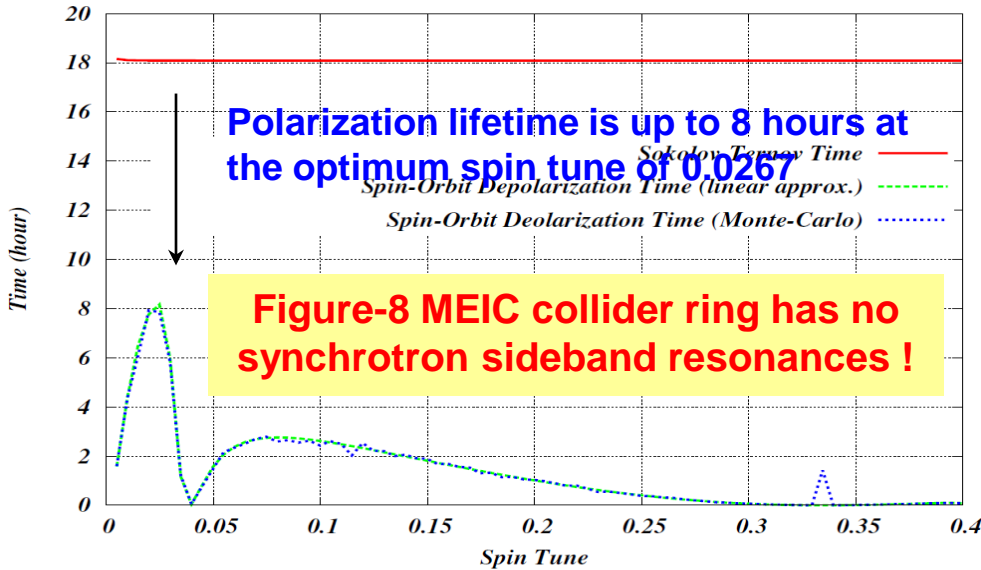

Typical LHeC calculations with very good alignment, rotators but artificial spin matching in SLICKTRACK. Note the sync. sideband effects.

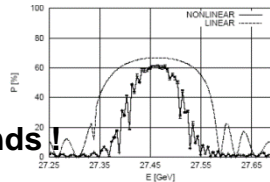
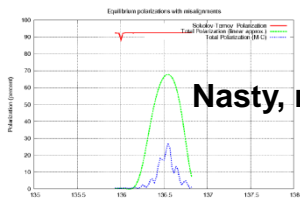

Polarization vs. energy for a HERA Upgrade lattice including the H1 and ZEUS solenoids: comparison of first order calculation (SLIM) and higher order calculations (SITROS).

M. Berglund, DESY-THESIS 2001-044 (2001).

• Continuous injection

- Obtains a high average luminosity
- Reaches a high equilibrium polarization

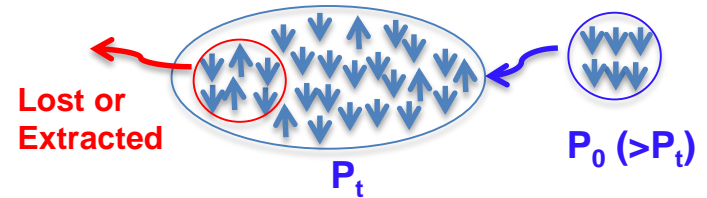

Equilibrium Polarization vs. Average Injected Current

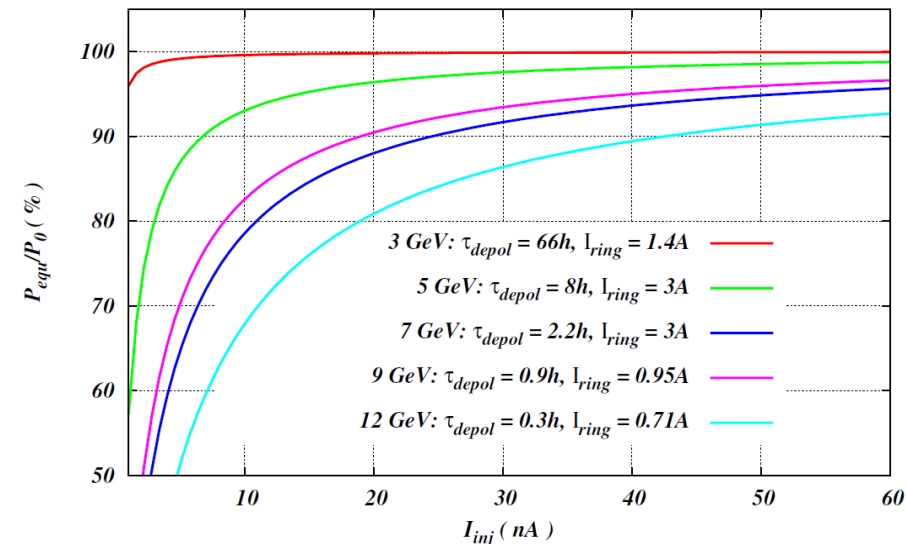

A relatively low average injected beam current of tens-of-nA level can maintain a high equilibrium polarization in the whole energy range.

Electron Collider Ring RF Design

- Re-use proven PEP-II RF stations
- 476 MHz HOM damped 1-cell cavities
 - 34 cavities available
- 1.2 MW klystrons, 13 available
 - Including power supplies etc.
- Current limited by synch. rad. power at high energy, impedance at low energy
- *Refurbishment will be needed*

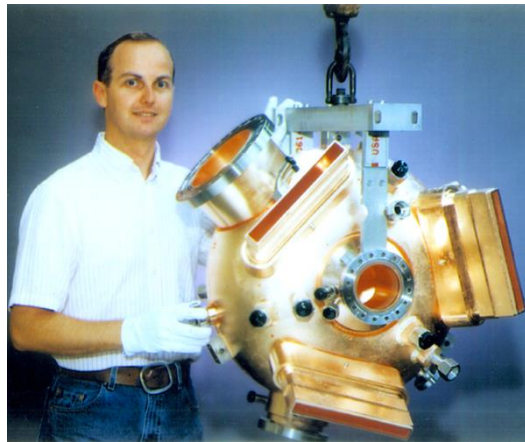
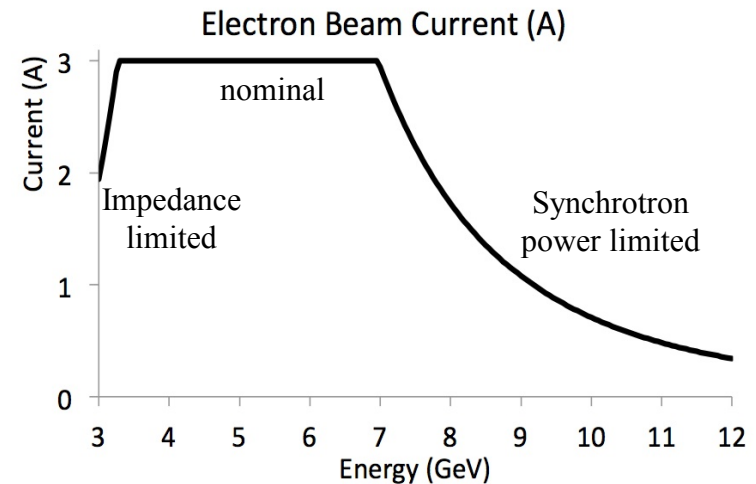

PEP-II RF cavity

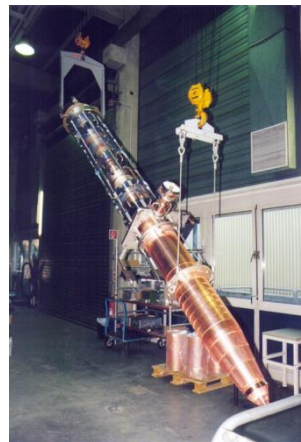

1.2 MW Klystron



2 MVA HVPS

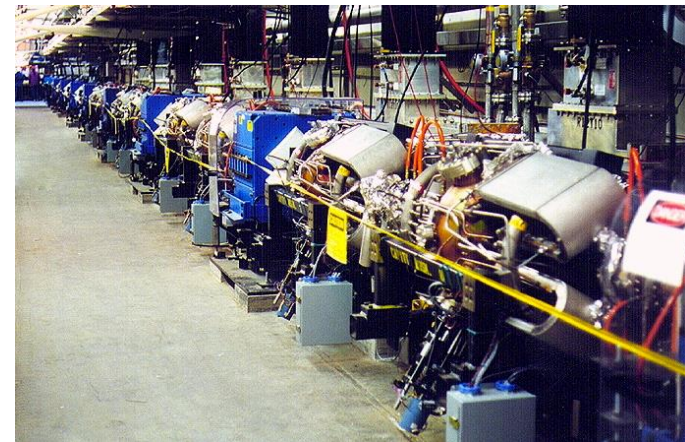

PEP-II Cavities in the SLAC tunnel