

RHIC Update

Executing the 2015 LRP

Berndt Mueller

NSAC Meeting

June 2, 2017

70 YEARS OF
DISCOVERY

A CENTURY OF SERVICE



BROOKHAVEN
NATIONAL LABORATORY

RHIC: A Unique Facility

- The world's most versatile facility for the exploration of the phases of QCD matter from high temperature to high baryon density.
- The world's first and only polarized proton collider and explores properties of the proton's spin.

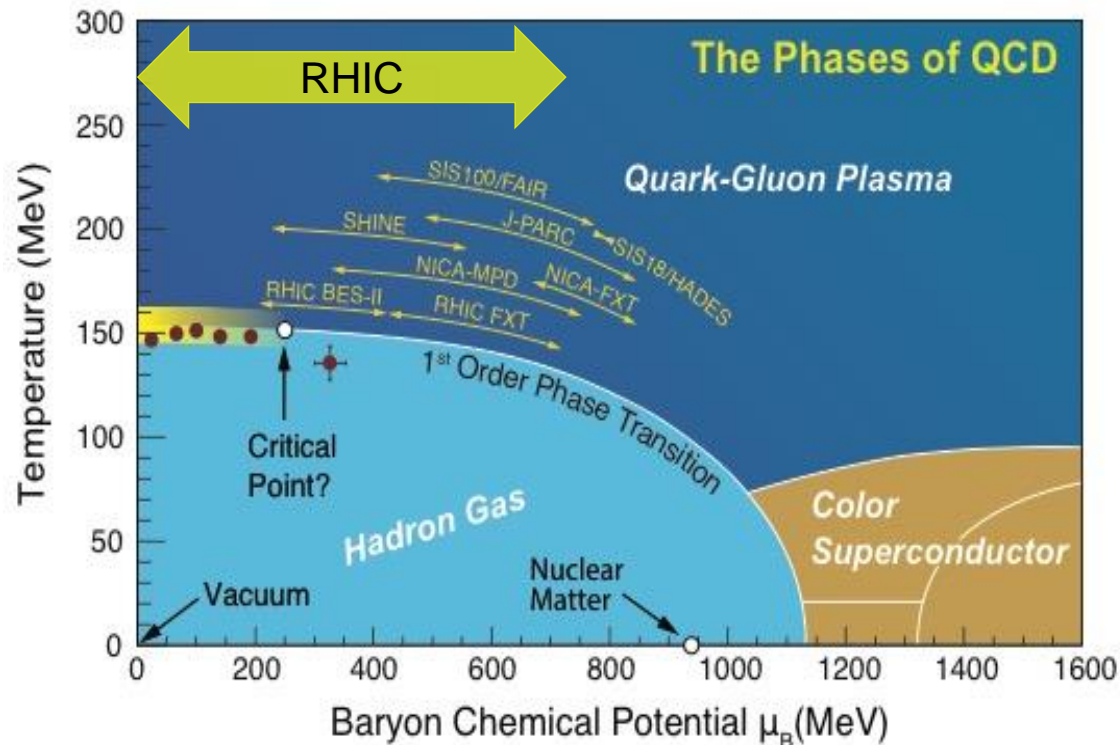

RHIC discoveries include:

- The quark-gluon plasma is a “perfect liquid”.
- Jet quenching in QCD matter.
- Gluons make a substantial contribution to the proton spin.

RHIC's Physics Program is Diverse

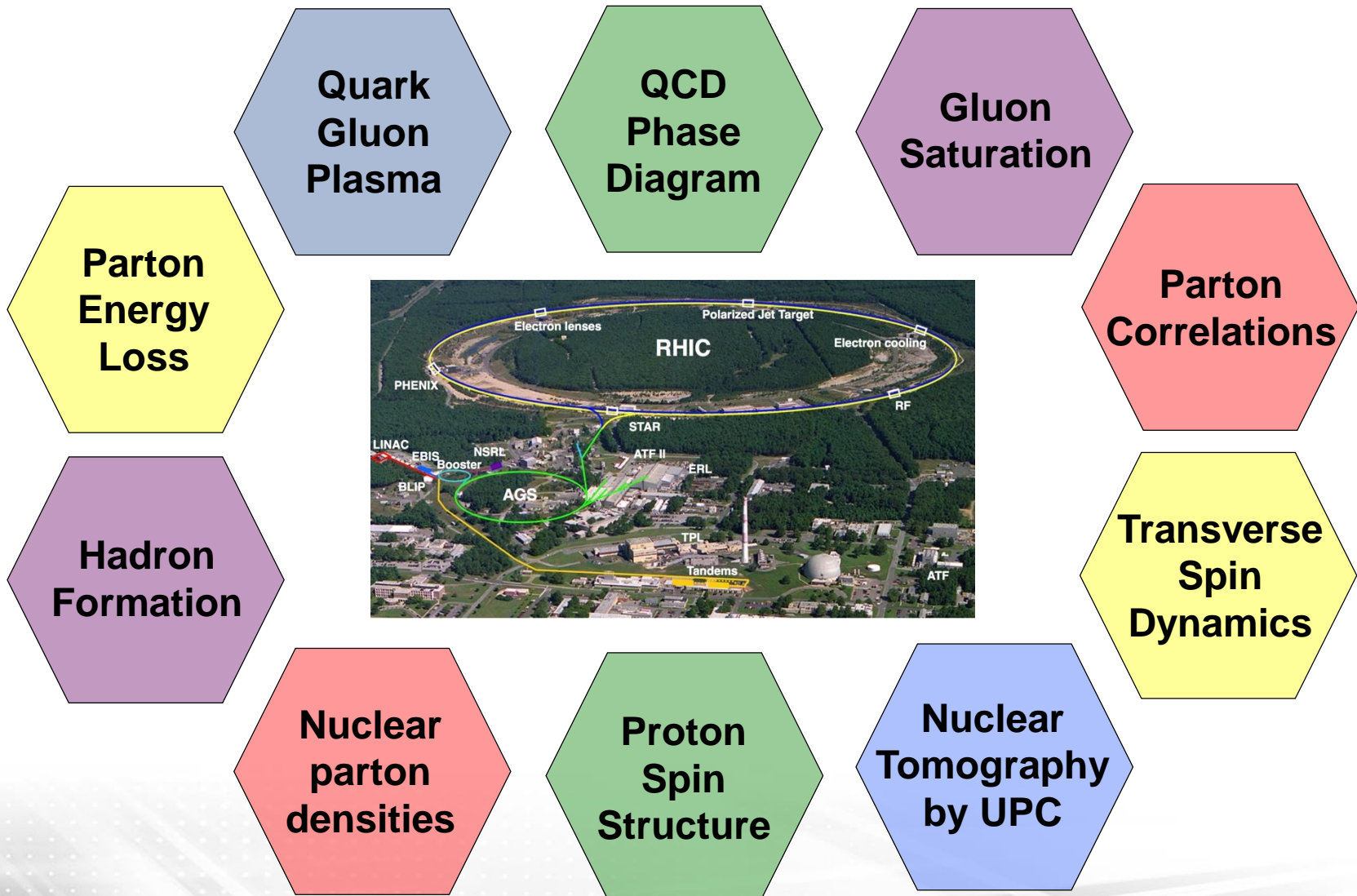

Record Luminosity and Aiming for More

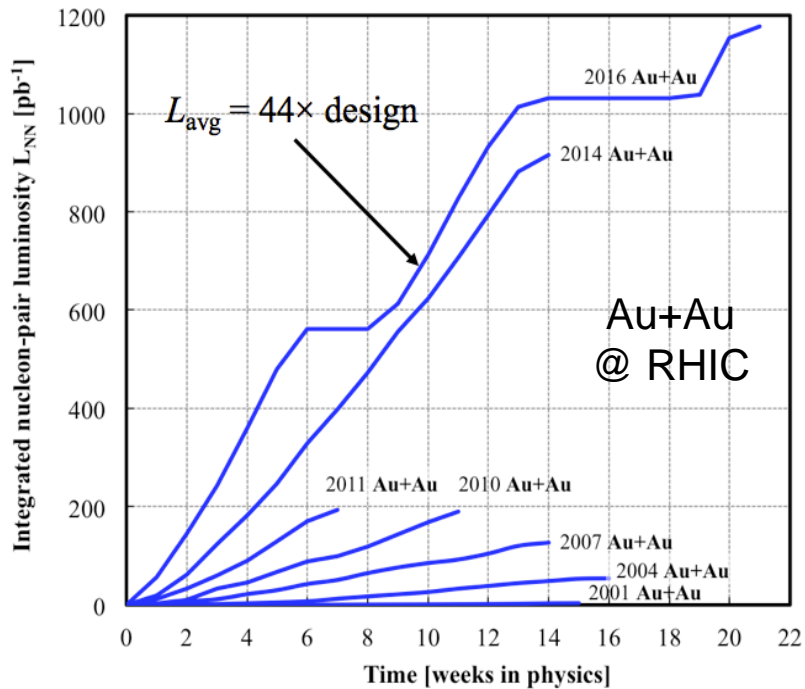

Average store luminosity for Au+Au has now reached 44 times the design value. In 10 minutes RHIC today produces more collisions than during the entire commissioning run in 2000.

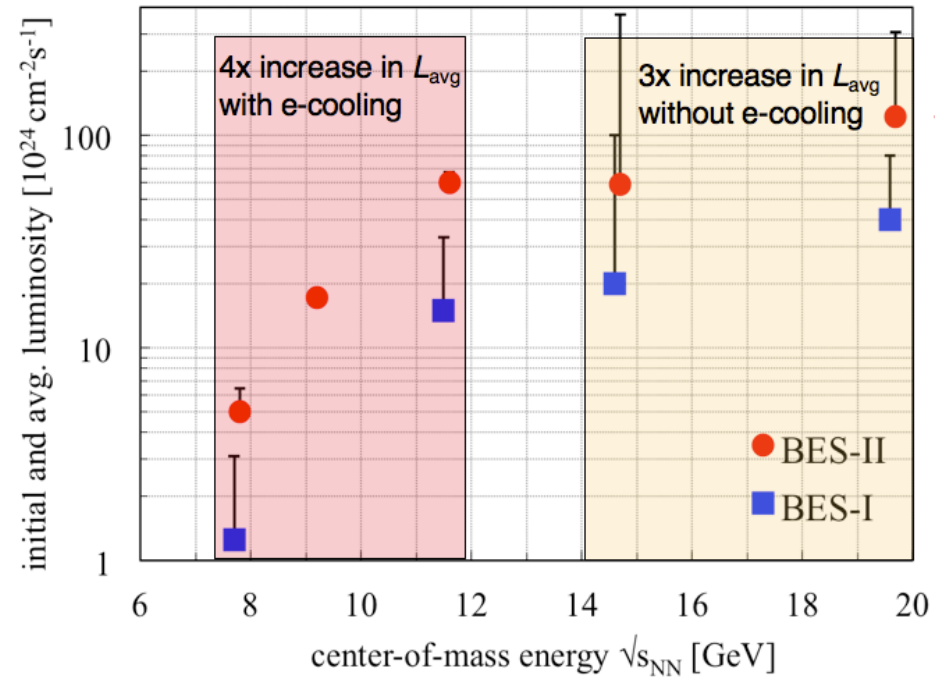

Electron cooling for the Beam Energy Scan II (BES-II) aims for a four-fold increase at the three lowest energies of the scan. A three-fold increase at the two highest energies is possible without cooling, and has been demonstrated in 2016.

RHIC Program Since 2015

- **Run 2015:**
 - Transverse and longitudinally polarized p+p at $\sqrt{s_{NN}} = 200$ GeV
 - **Baseline comparison runs (p+p, p+Au) for heavy flavor program**
 - Polarized p+Au and p+Al at $\sqrt{s_{NN}} = 200$ GeV
 - **Gluon helicity; transverse spin in QCD; nuclear PDFs**
- **Run 2016:**
 - High statistics Au+Au at $\sqrt{s_{NN}} = 200$ GeV
 - **Precision measurement of heavy flavor dynamics in the QGP**
 - d+Au beam energy scan
 - **Energy dependence of collective flow in small systems**
- **Run 2017 (ongoing):**
 - High luminosity transverse polarized p+p at $\sqrt{s_{NN}} = 510$ GeV
 - **Study of scale evolution of the transverse momentum dependent parton distributions and sign change of the Sivers function**
 - Au+Au at $\sqrt{s_{NN}} = 53$ GeV
 - **Study of longitudinal correlations in QGP initial conditions & energy dependence of jet quenching**

RHIC Highlight (1): Παντα ρει

Elliptic flow of D0 mesons (charm quarks)

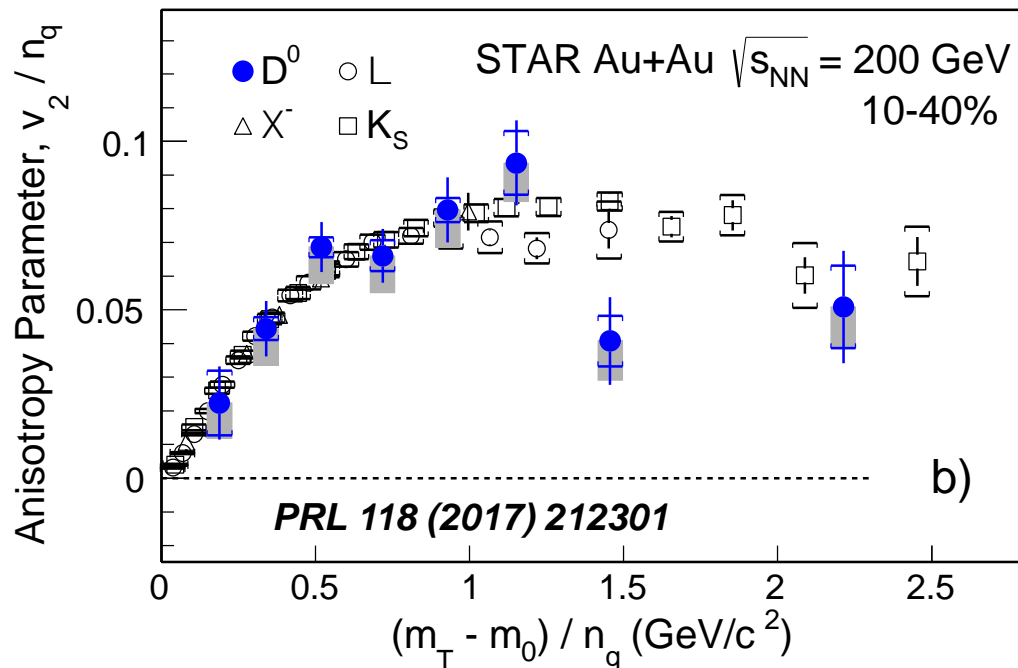

Heavy Flavor Tracker: >10-year development - first use in a collider experiment

Enabling technology: High-precision low-mass Monolithic" Active Pixels

Result: Charm quarks flow just as well as lighter quarks – “Perfect liquid”

RHIC Highlight (2): Παντα ρει

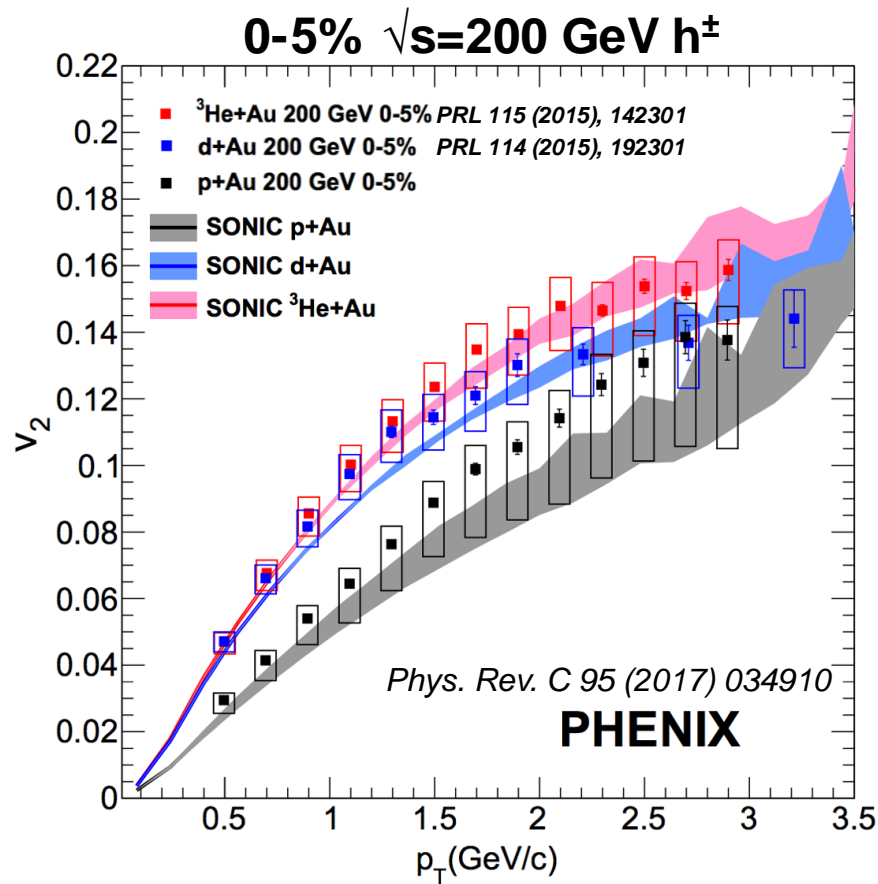

Signatures of collective flow exist even in the smallest systems and at the lowest RHIC energies

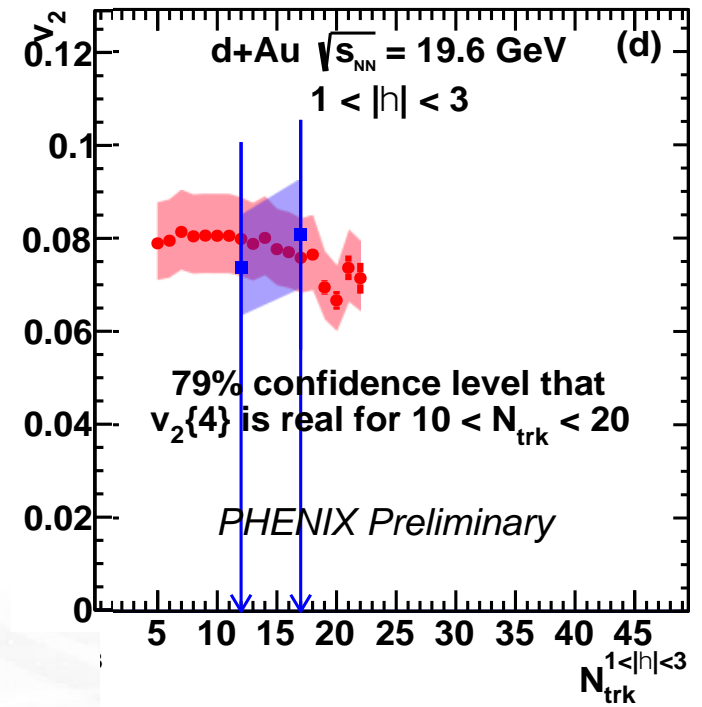
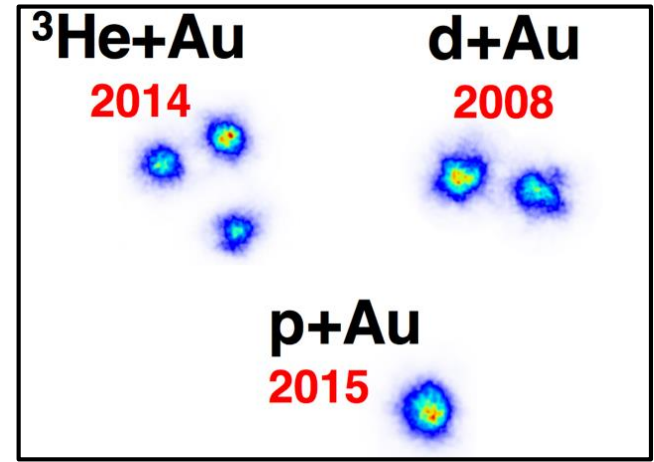

RHIC Highlight (3): The most vortical fluid

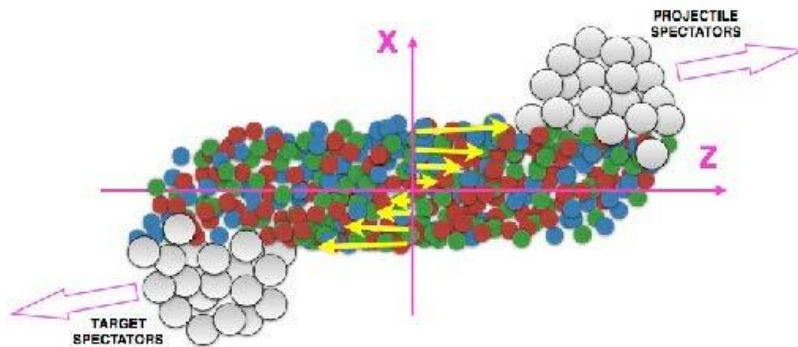

Global collision angular momentum generates QGP vorticity

$$P_{\pm} \sim \exp \left[\pm \frac{\frac{1}{2} \hbar \omega + \mu B}{T} \right] \quad (\mu_{\Lambda} = -\mu_{\bar{\Lambda}})$$

Global Lambda Polarization is signal of vorticity

Strongest signal at Beam Energy Scan (BES-II) energies

Signal is consistent with **vorticity** $\omega = (9 \pm 1) \times 10^{21} \text{s}^{-1}$, greater than previously observed in any system, including nuclei in high-spin states

Holds potential for measurement of late time magnetic field in BES-II

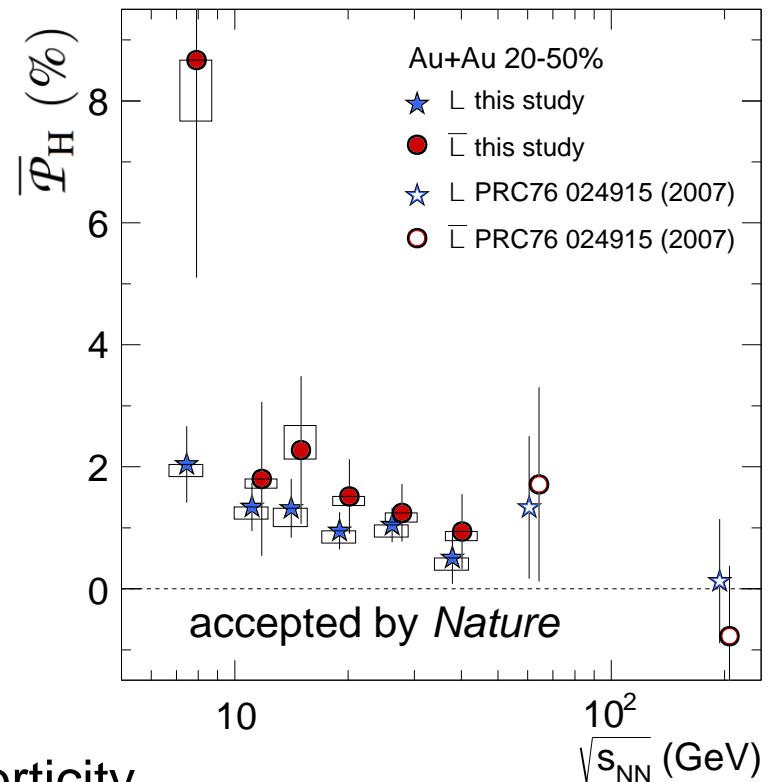

RHIC Highlight (4): Transverse spin in QCD

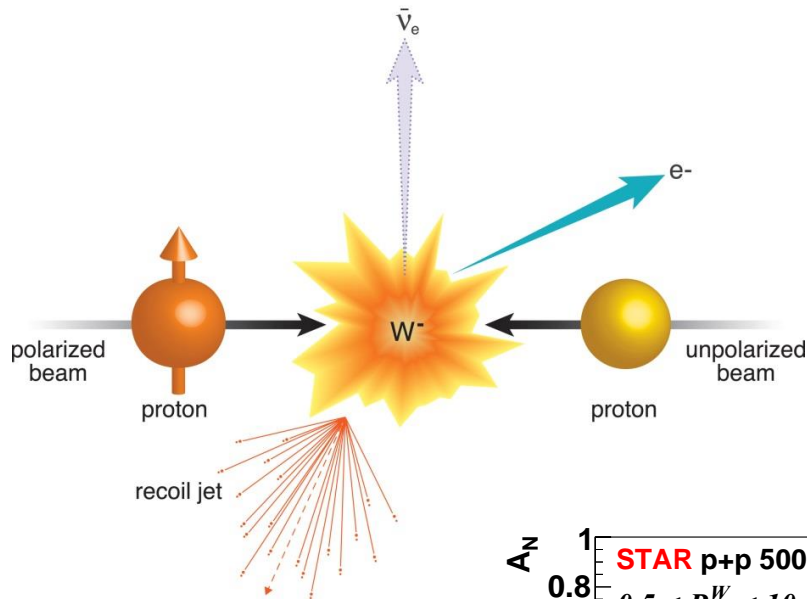

2011 Run established feasibility – results favor a TMD Sivvers function sign change, but are not definitive ($\sim 2\sigma$)

2017 Spin Run will yield a definitive test, including TMD evolution with scale, which is important for EIC predictions

Scale evolution of the Sivvers effect will be measured comparing W-production with DY $e+e^-$ pair production at 5–10 GeV

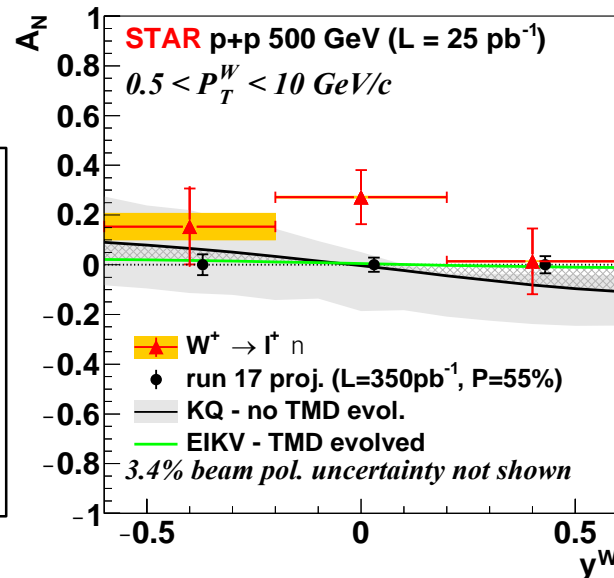

Phys. Rev. Lett. **116** (2016) 132301

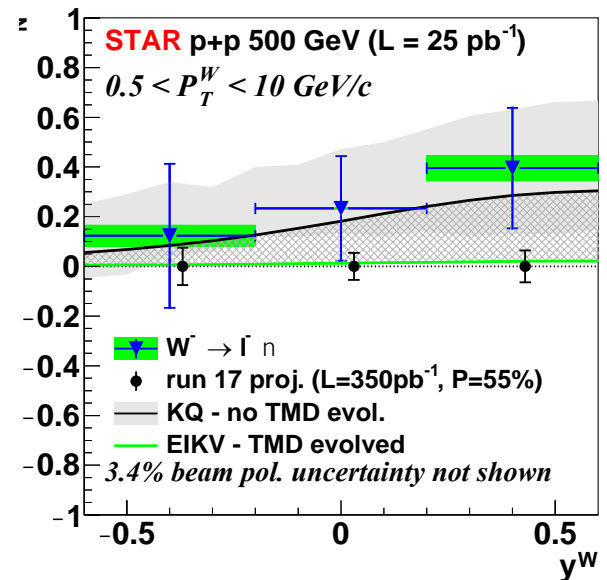

RHIC Future Plans

- ***Run 2018:***
 - High statistics isobar system ($^{96}\text{Ru} - ^{96}\text{Zr}$) comparison run
 - **Test of signatures of Chiral Symmetry Restoration in the QGP**
- ***Completion of the Low-Energy electron Cooling Upgrade***
- ***Installation of STAR inner TPC Upgrade***
- ***Runs 2019-20:***
 - High statistics Au+Au beam energy scan ($\sqrt{s_{\text{NN}}} = 7\text{--}20 \text{ GeV}$)
 - **Search for signs of critical phenomena in event-by-event fluctuations, including search for a critical point**
- ***Completion and Installation of the sPHENIX Upgrade***
- ***Runs 2022++:***
 - Au+Au, polarized p+p, p+Au $\sqrt{s_{\text{NN}}} = 200 \text{ GeV}$
 - **Precision measurements of fully resolved jets and Upsilon states using the new sPHENIX detector (received CD-0 in 2016)**
 - **Cold QCD measurements to unambiguously separate intrinsic properties of nuclei from process dependent phenomena (EIC!)**

RHIC Future (1): Chiral Symmetry & Topology

Topology is a fundamental characteristic of QCD
Observation of topological field fluctuations requires

- (nearly) massless quarks = chiral symmetry
- superstrong magnetic fields

Heavy ion collisions provide both!

The chiral anomaly of QCD creates local fluctuations in the number of left and right handed quarks

An excess of right- or left-handed quarks will cause an electric current to flow along the magnetic field:
Chiral Magnetic Effect (CME)

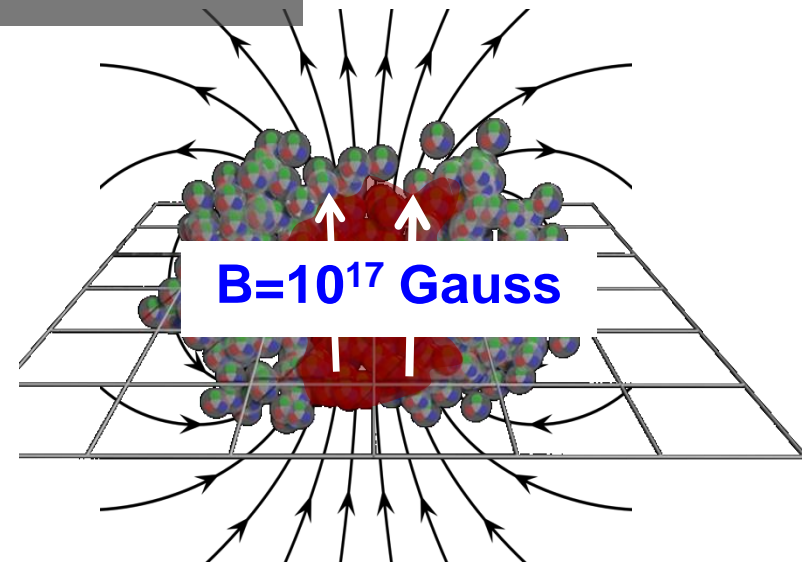

When clearly established experimentally, the CME provides for an unambiguous signal of chiral symmetry restoration.

RHIC Future (1): Chiral Symmetry & Topology

Various signals of fluctuating charge separation with respect to the reaction plane have been observed, but these could be caused by background effects in correlation with elliptic flow.

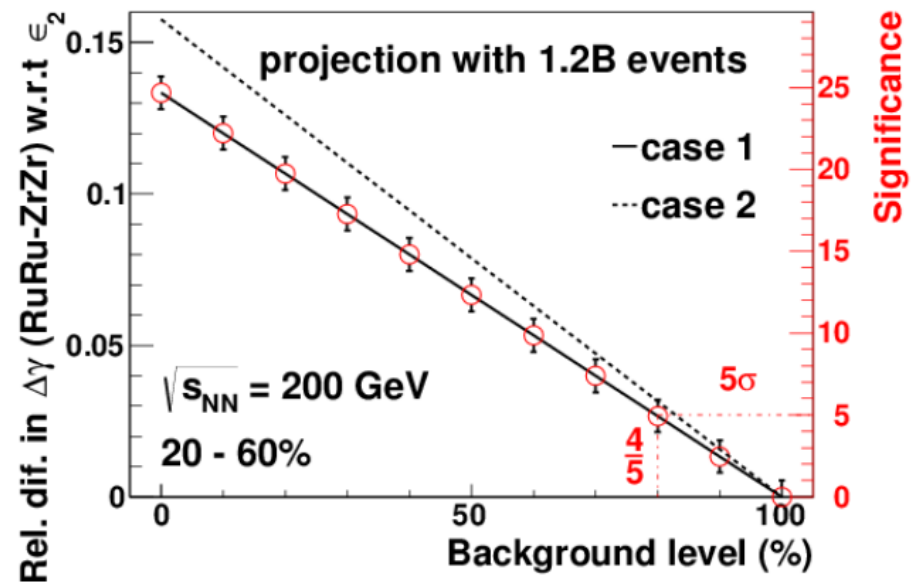
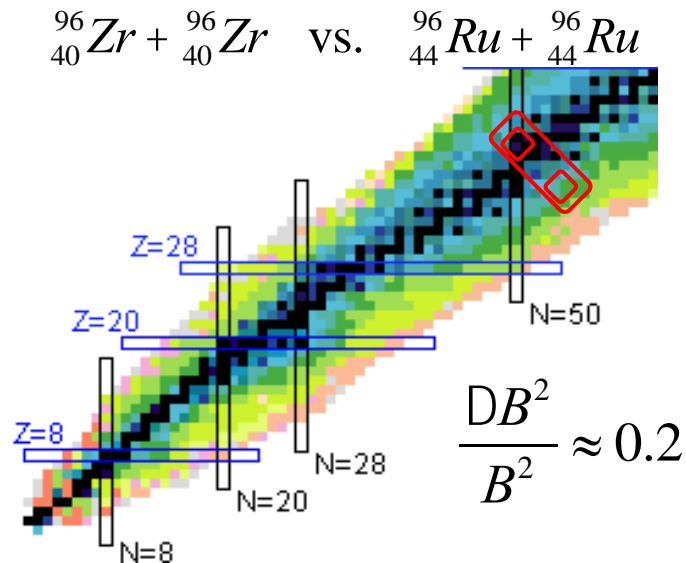

The isobar comparison run in 2018 can tell us to with +/- 6% precision what fraction of the observed charge separation is due to the CME.

RHIC Future (2): Doping the QGP to Criticality

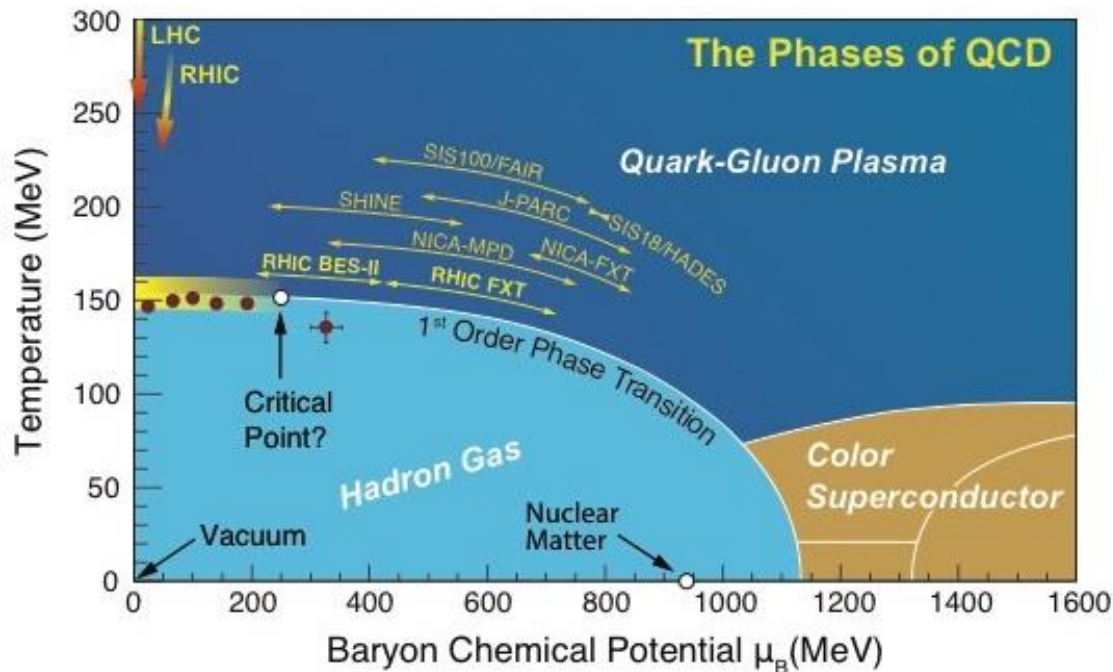

In the QGP critical behavior is predicted to be reached by **doping with net baryons (protons)**

Critical Opalescence near a critical point is indicative of long-range fluctuations

Most robust signal of criticality is a characteristic change in the non-Gaussian distribution of event-by-event net proton fluctuations

Critical signature: Net-proton kurtosis

Near a critical point, the correlation length of fluctuations diverges; kurtosis ($\kappa-1$) of the net-proton distribution changes sign

Expected behavior near critical point

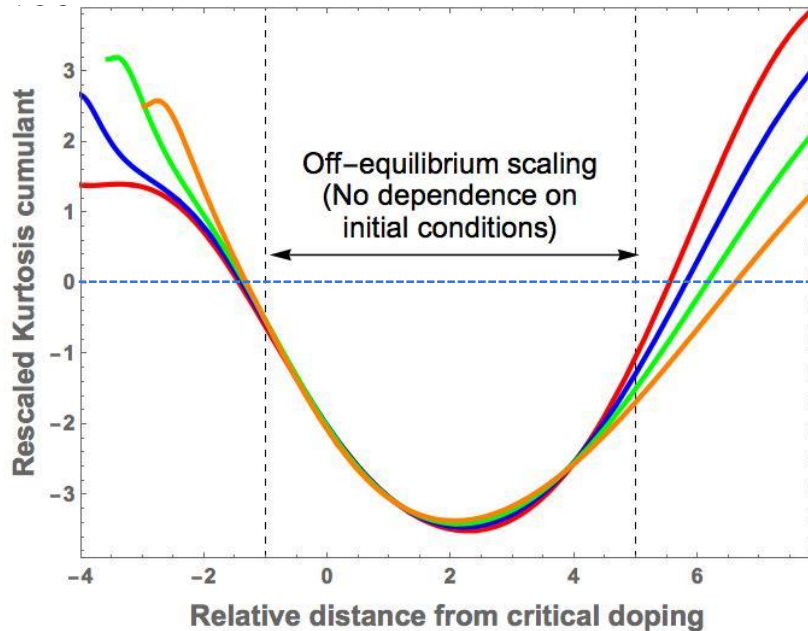

Net-baryon/proton density of the QGP is controlled by the collision energy

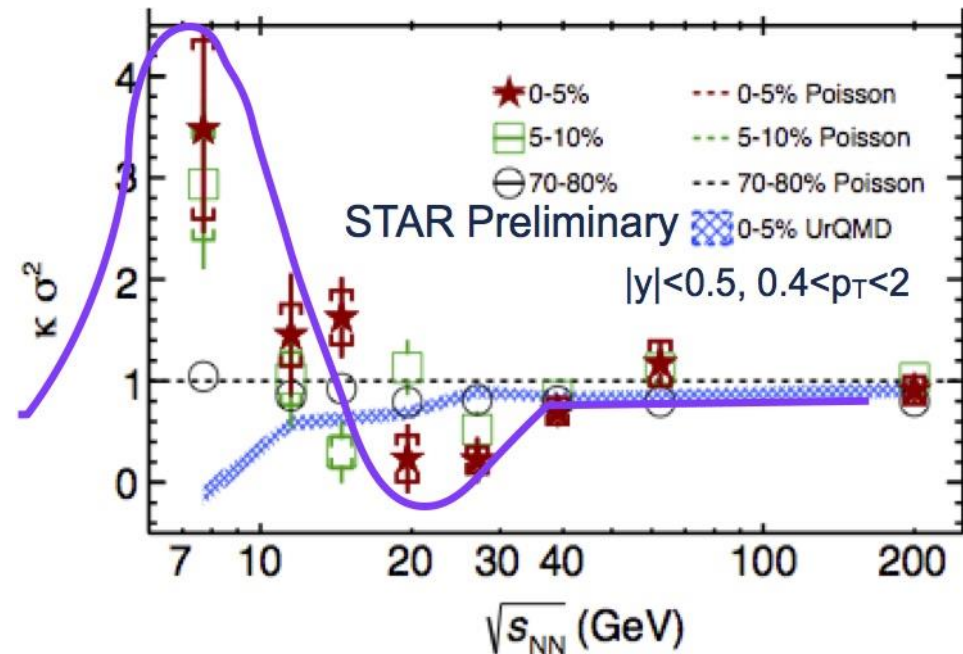

BES I provided a tantalizing hint, but with insufficient precision

Upgrades for BES-II

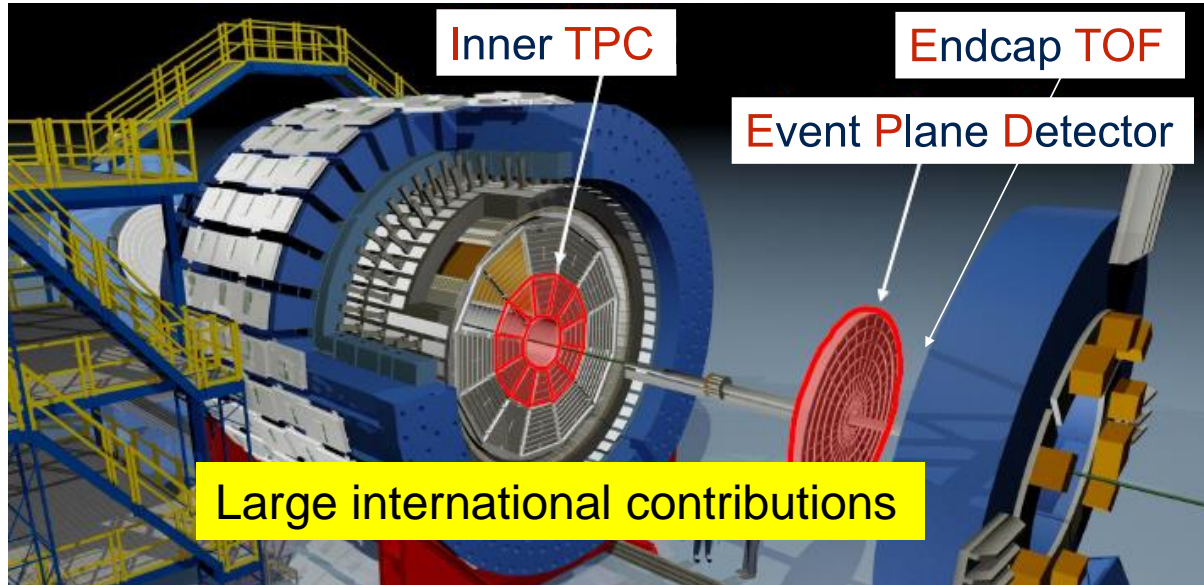

Enhanced detector coverage

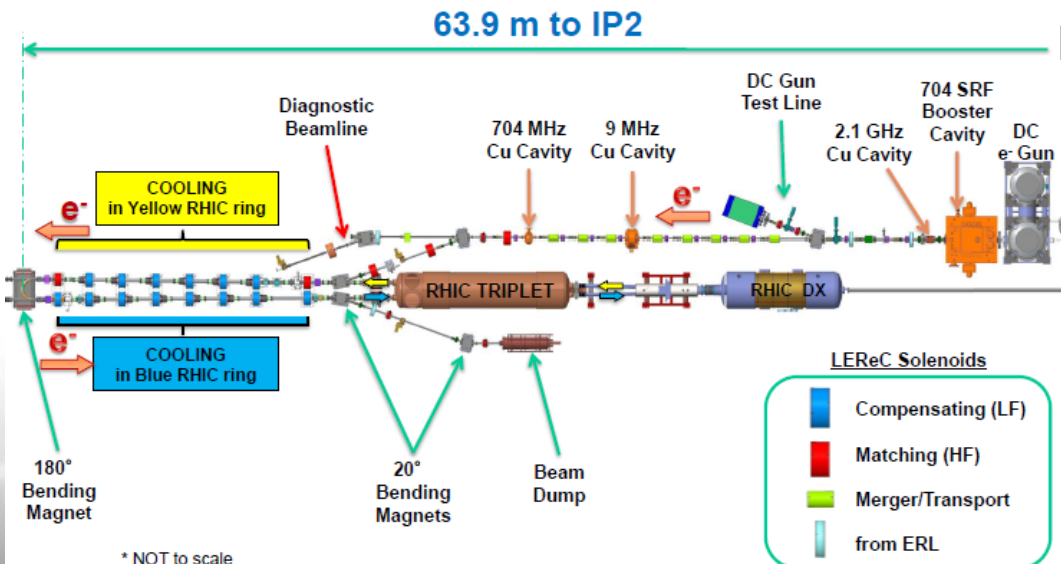

Beam cooling for increased luminosity



LEReC and iTPC Acceptance

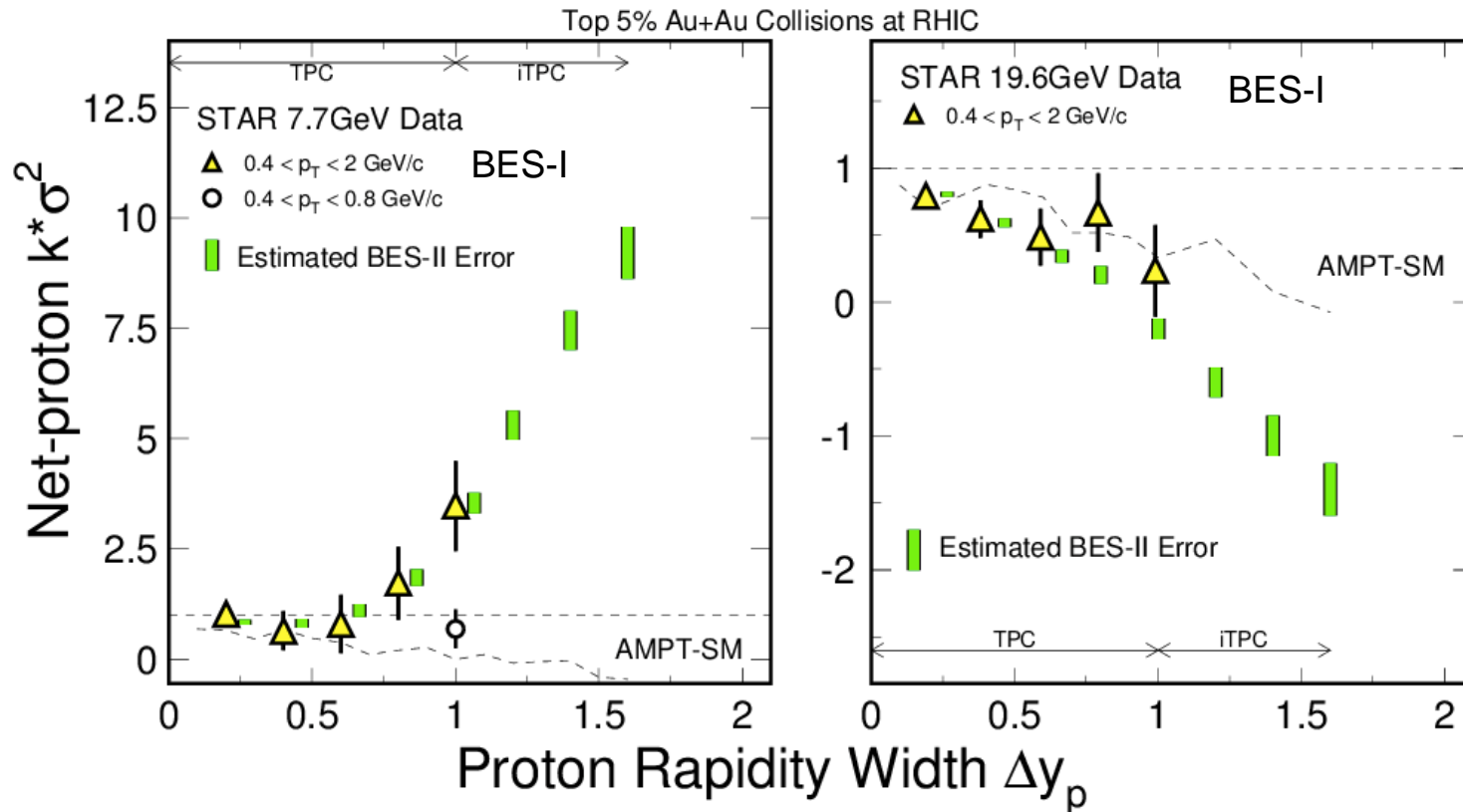

Kurtosis (fourth-order fluctuations) signal grows like $(\Delta y)^3$
→ Detector coverage is critical for a definitive measurement

Increased luminosity reduces error bars

RHIC Future (3): sPHENIX

State-of-the-art jet (and Upsilon & open heavy flavor) detector

SC BaBar Solenoid 1.5 T

Coverage $|\eta| \leq 1.1$

Inner Si Tracking

Fast TPC w/GEM Read-out

Projective Electromagnetic
Calorimeter

Hadronic Calorimeter

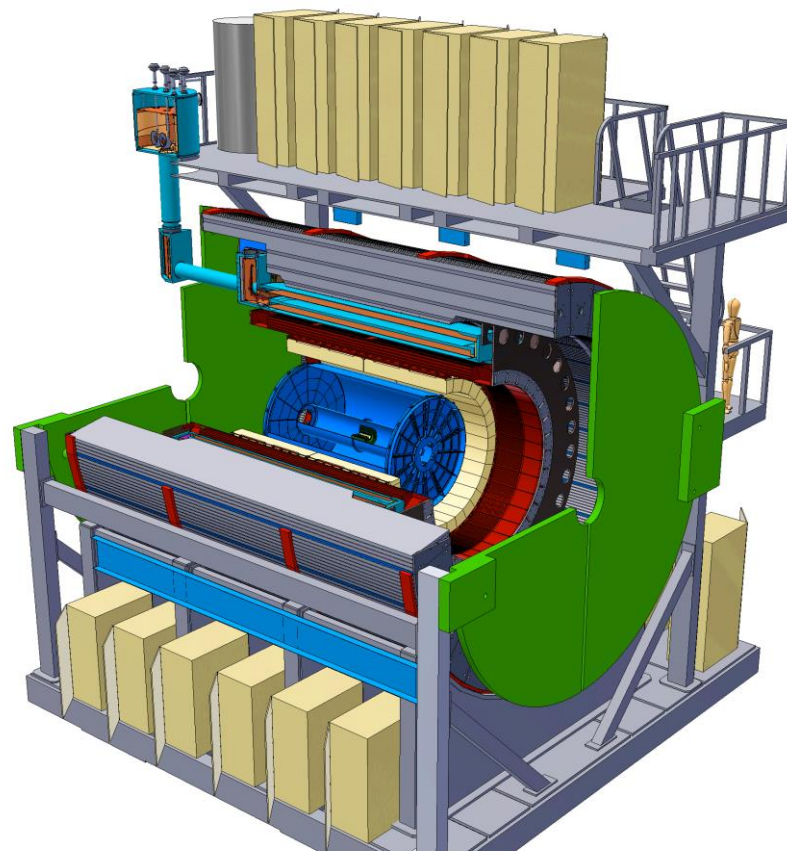

Capable of sampling 600 billion Au+Au interactions
and recording 100 billion min bias events per year

Jet Probes of QCD Structure

Parton virtuality evolves quickly and is sensitive to the medium at the scale it probes

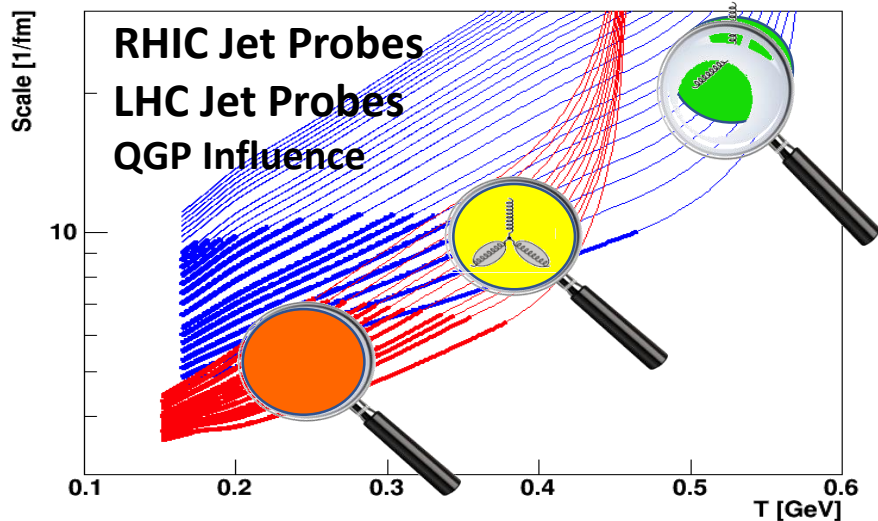

Unique critical microscope resolution range at RHIC

Kinematic overlap between RHIC and LHC provides complementarity

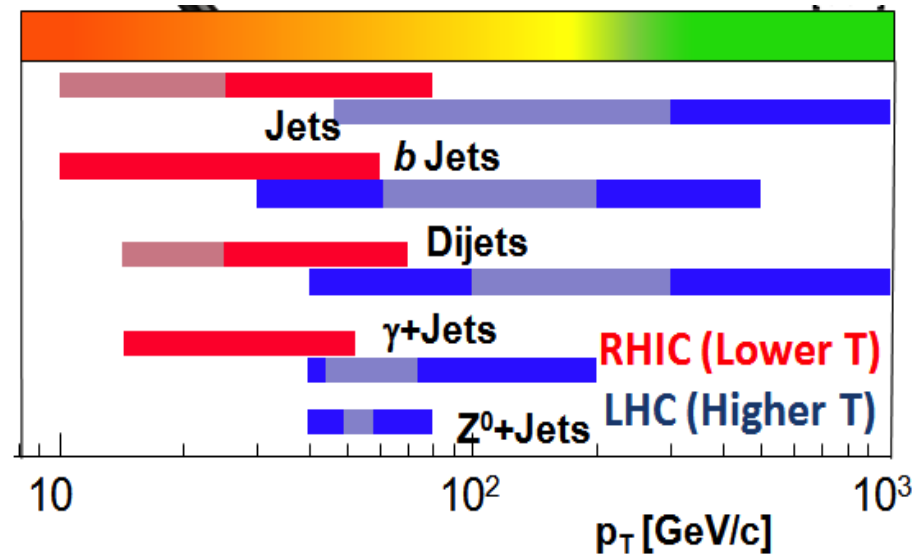
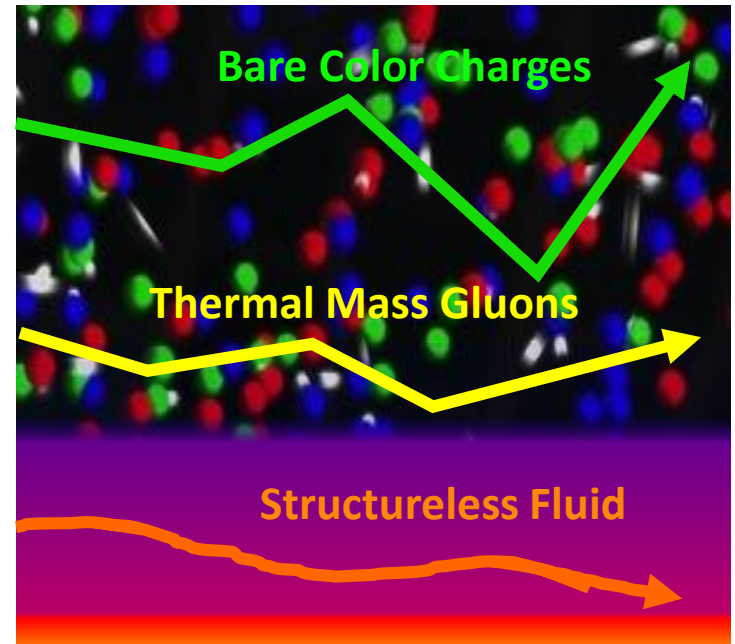

“What RHIC Will Deliver”

- **Campaign 1 (2014-17):**

- ✓ QCD equation of state at $\mu_B \approx 0$
- ✓ Precision measurement of $\eta/s(T \approx T_c)$
- ✓ Measurement of heavy quark diffusion constant $D_{c/b}$
- ✓ Measurement of x-dependence of nuclear granularity
- ✓ Origin of single spin asymmetries
- ✓ ΔG , flavor dependence of spin in the quark sea
- ✓ QGP vorticity [not anticipated in 2015]

- **Campaign 2 (2018-20):**

- Chiral symmetry restoration via CME
- QCD equation of state at $\mu_B > 0$
- Discovery of the QCD critical point, if within the accessible range

- **Campaign 3 (2022++):**

- Precision measurement of $q^{\wedge}(T \approx T_c)$ and $e^{\wedge}(T \approx T_c)$
- Determine length scale where the QGP becomes a liquid
- Cold QCD measurements critical to EIC physics

The RICH Opportunities of RHIC

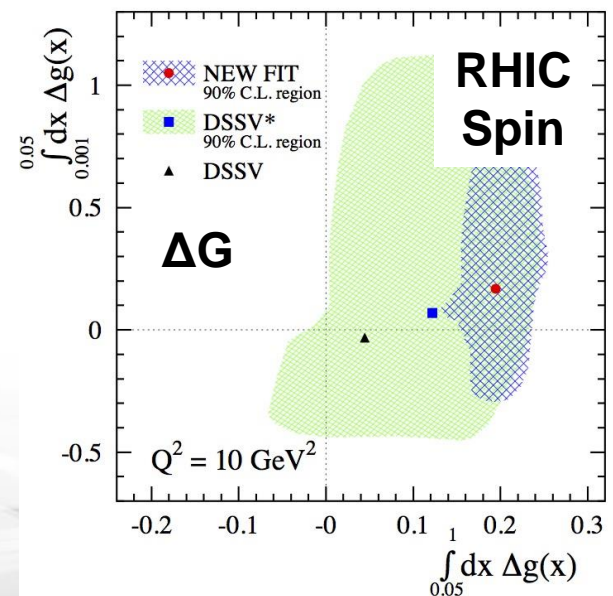
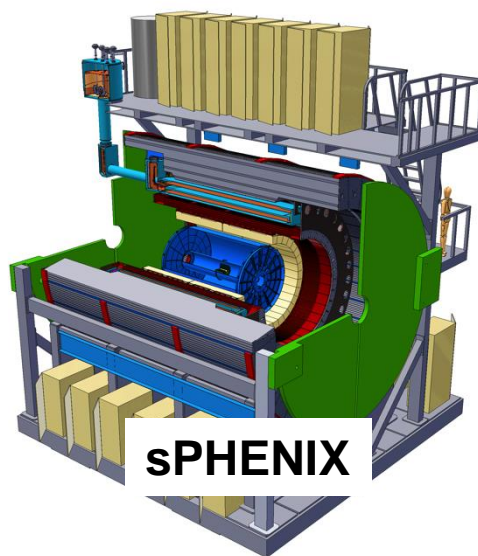
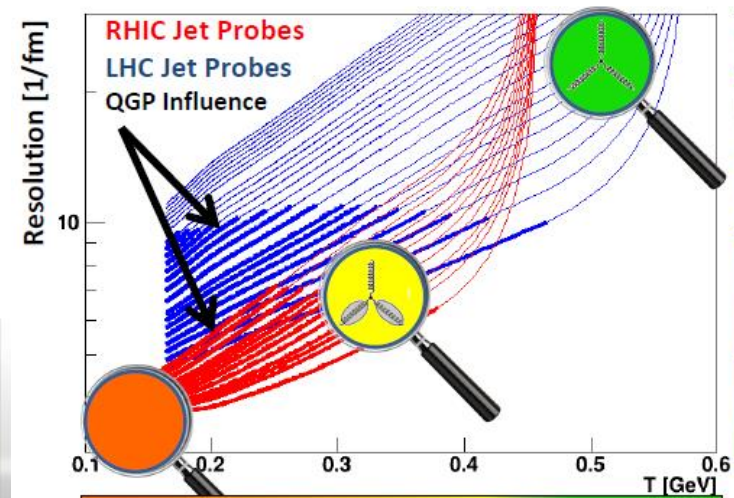
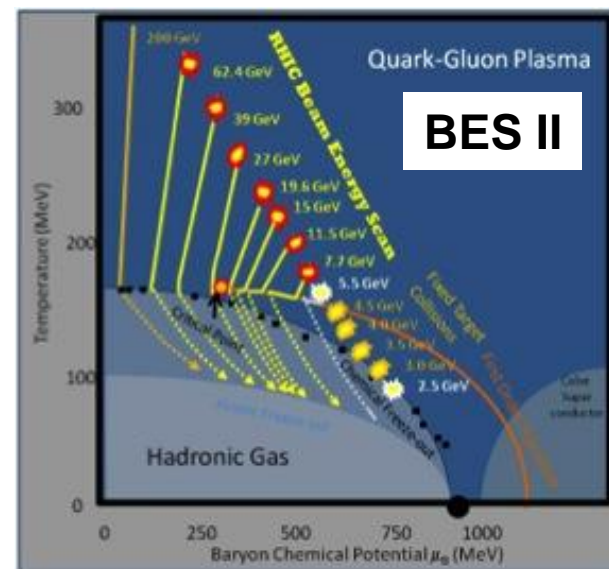
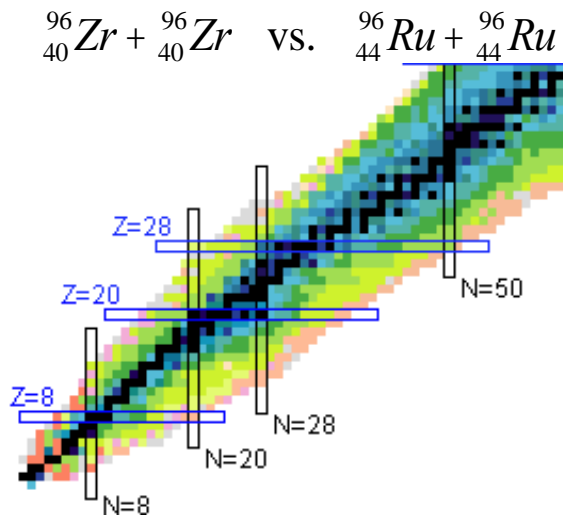
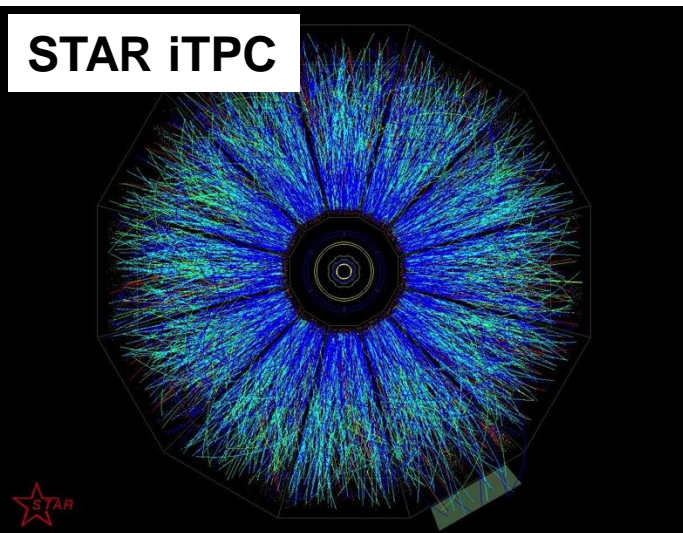

Backup slides

RHIC Delivers Whatever it Takes

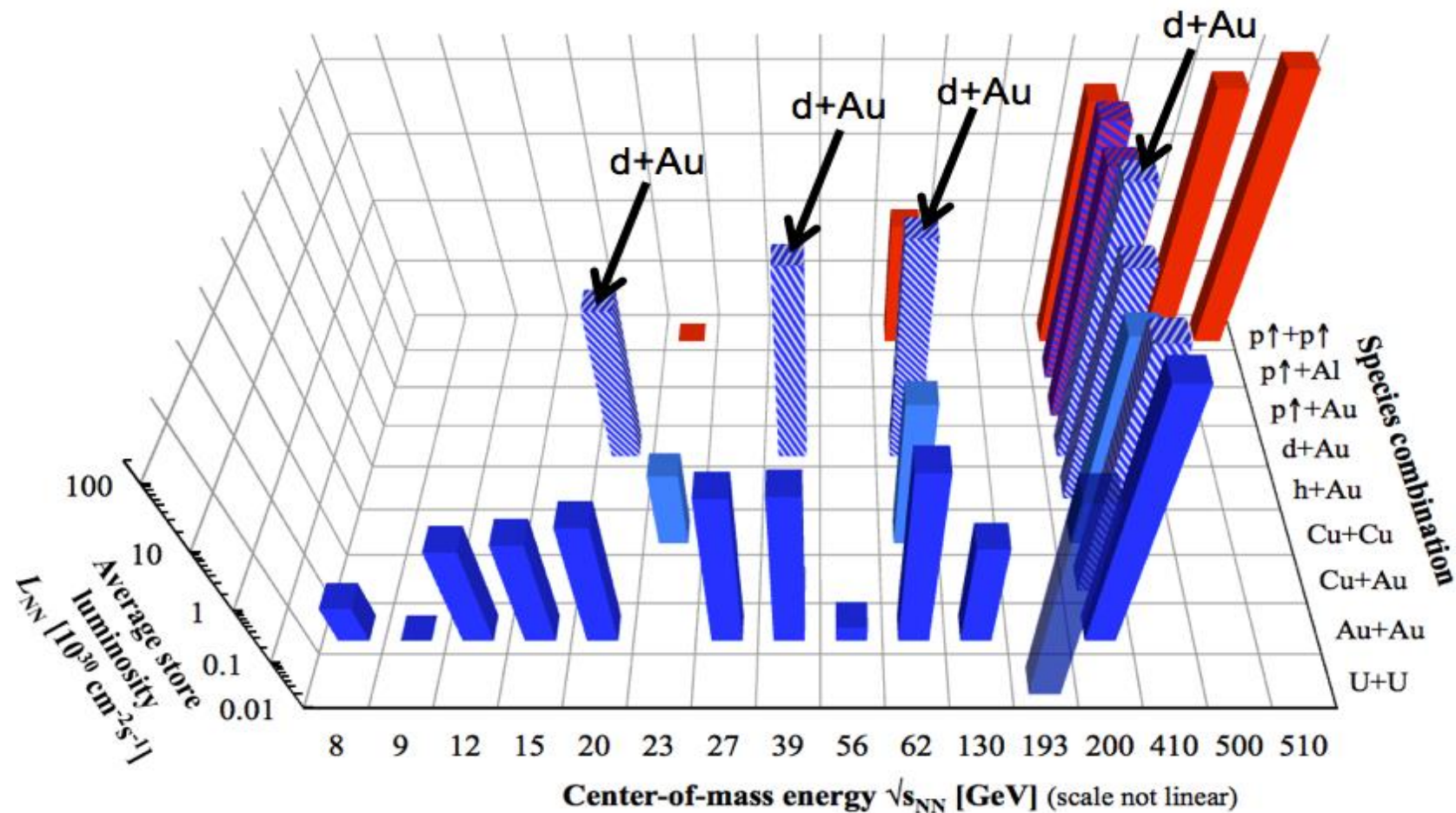

In 2016 RHIC collided deuterons with gold ions at four different energies with setup times as low as 0.8 days between energies.

Lumpy Protons

Proton: sum of gluon clouds around 3 valence quarks

$$T_{\text{proton}}(b) = \sum_{i=1}^3 T_q(b - b_i)$$

with $T_q(b) \sim e^{-b^2/(2B_q)}$

Lumpy: $B_{qc} = 3.3, B_q = 0.7$

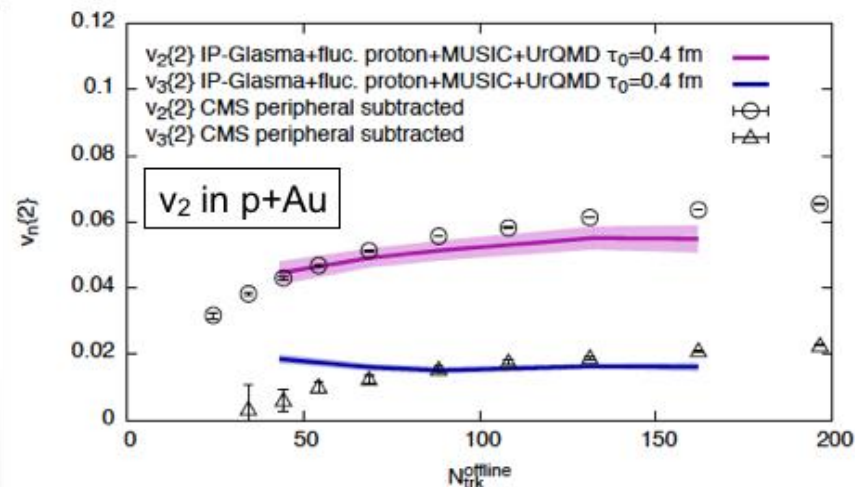
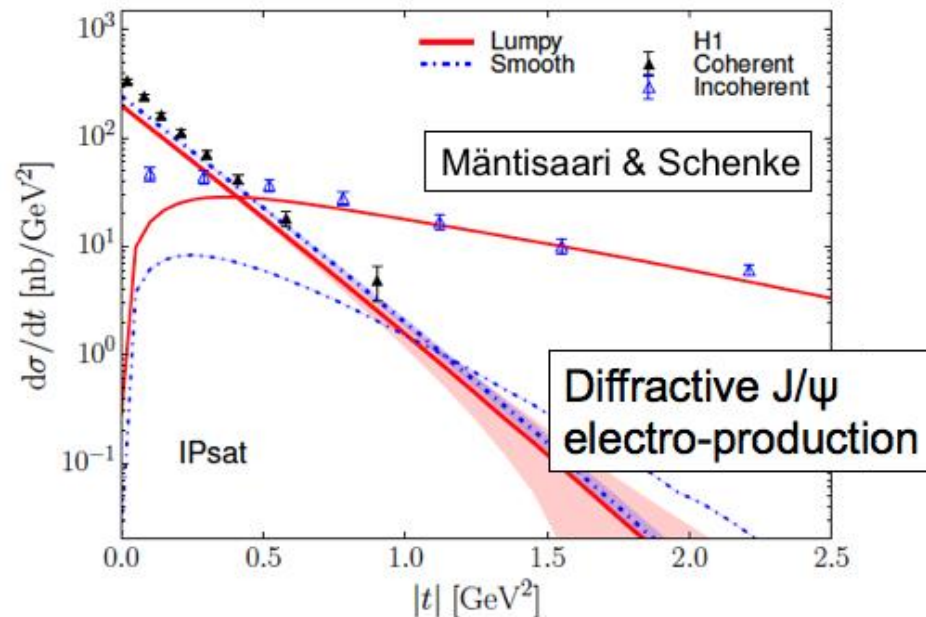
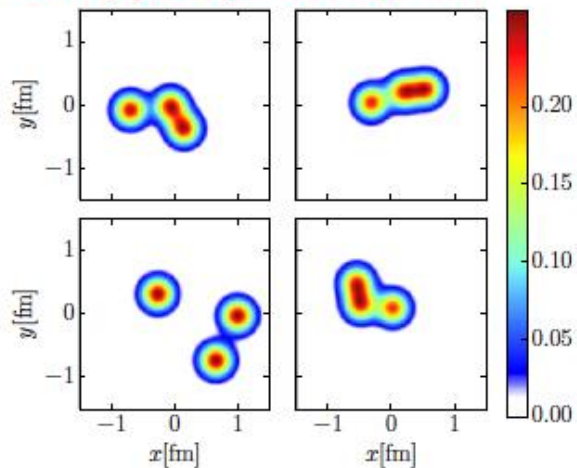

RHIC Highlight (3): The most vortical fluid

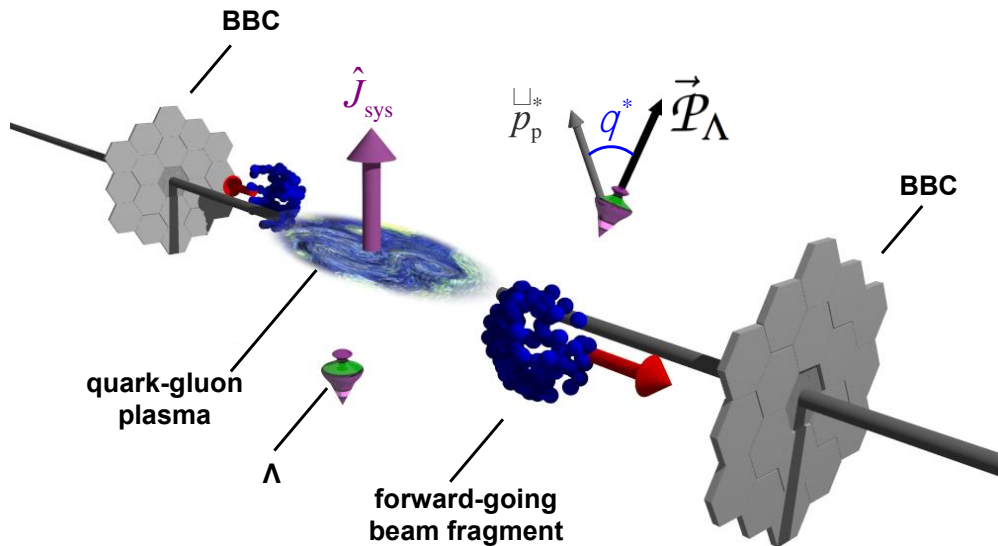

$$P_{\pm} \sim \exp \left[\pm \frac{\frac{1}{2} \hbar \omega + \mu B}{T} \right] \quad (\mu_{\Lambda} = -\mu_{\bar{\Lambda}})$$

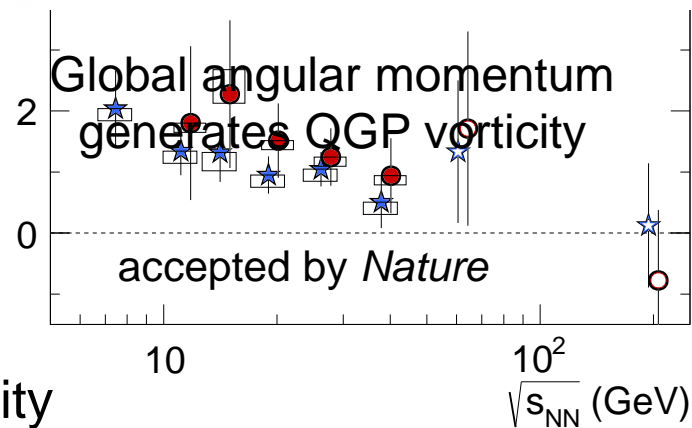
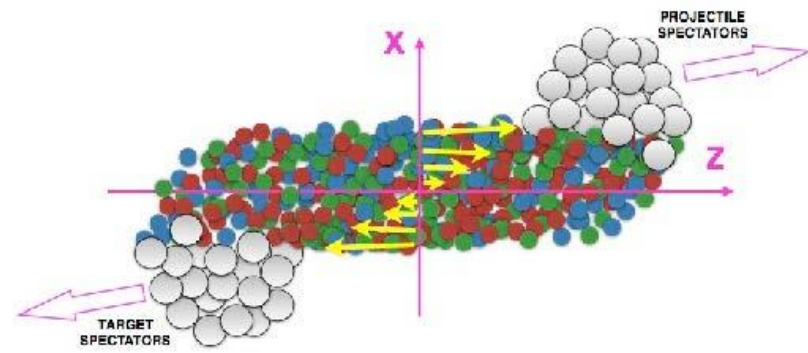

Global Lambda Polarization is signal of vorticity

Strongest signal at Beam Energy Scan (BES-II) energies

Signal is consistent with **vorticity** $\omega = (9 \pm 1) \times 10^{21} \text{s}^{-1}$, greater than previously observed in any system, including nuclei in high-spin states

Holds potential for measurement of late time magnetic field in BES-II

RHIC Future (1): QGP Topology

The chiral anomaly of QCD creates local fluctuations in the number of left and right handed quarks

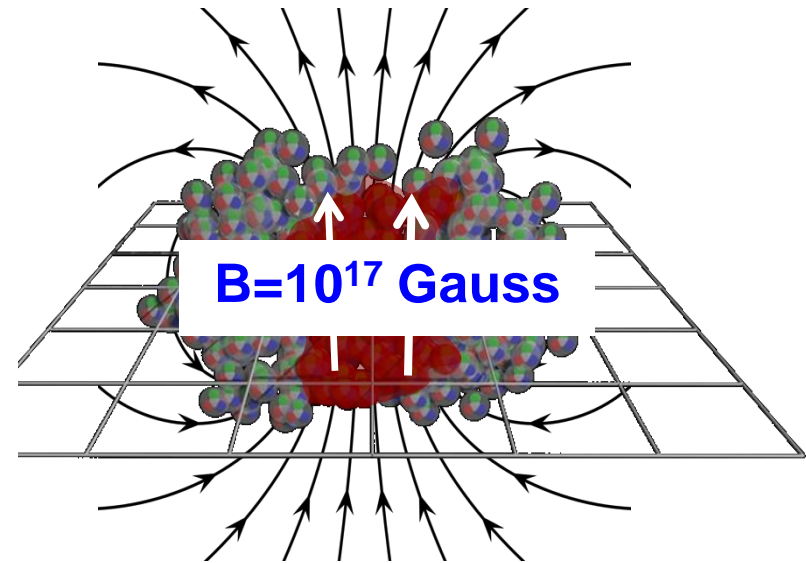
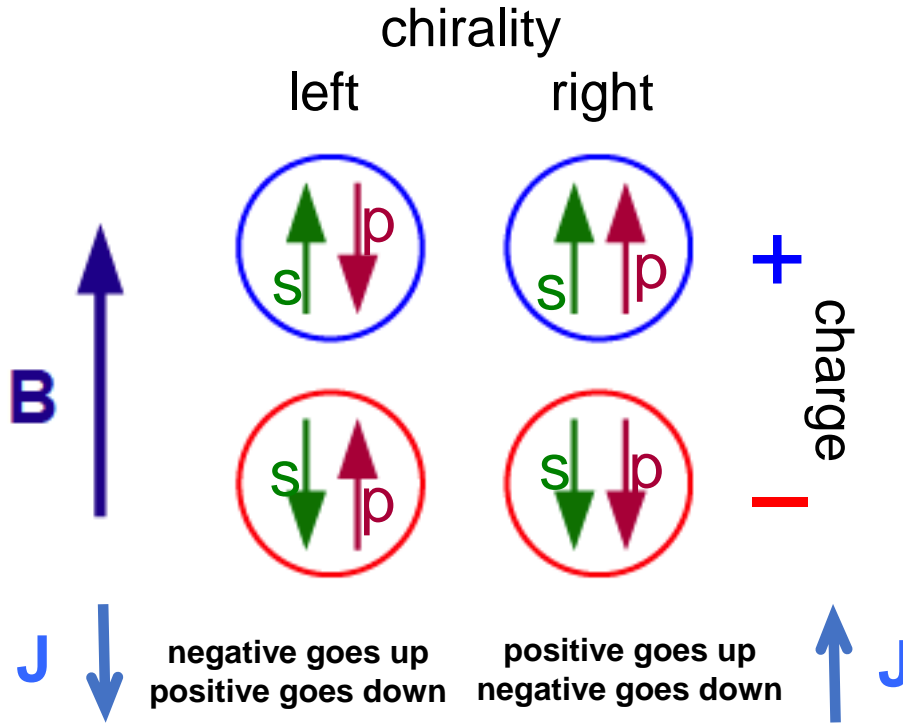

An excess of right- or left-handed quarks will cause an electric current to flow along the magnetic field

LEReC Setup

Cooling sections



Injection Section

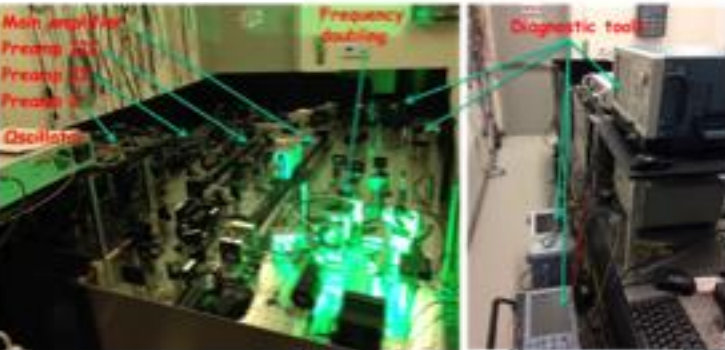

Laser

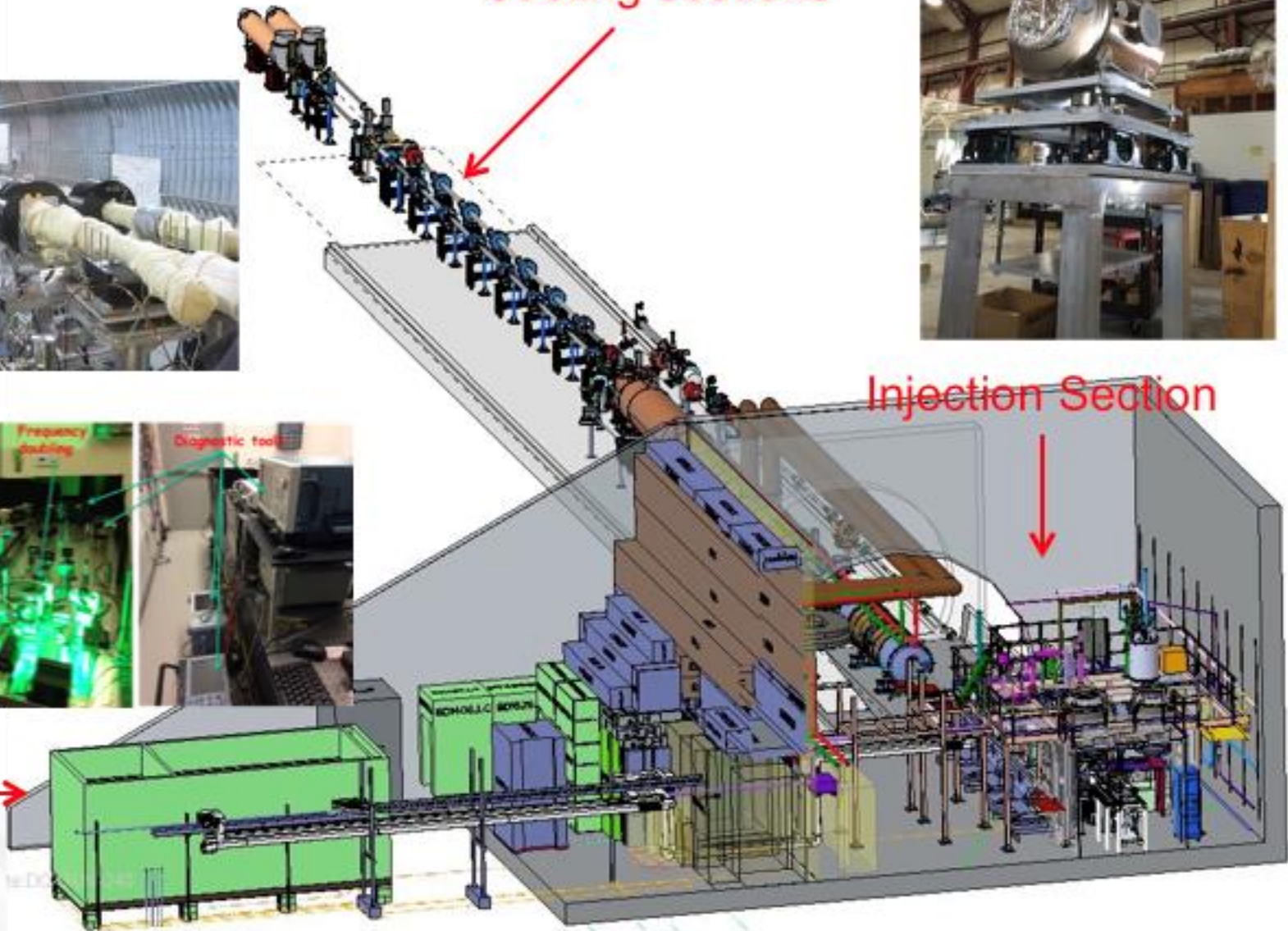

sPHENIX $\sqrt{s_{NN}} = 200$ GeV tentative run plan

Year	Species	Goals
2022	Au+Au	Commissioning Single jet, di-jet, photon-tagged jet, b-tagged jet spectra D-jet asymmetry Upsilon spectra
2023	p+p p+Au	Reference data for modification of jets, di-jets, b-tagged jets Jet A_{LL} Reference data for cold nuclear matter effects
2024	Au+Au	Direct photon measurement Study of flavor dependence of jet observables Modification of jet fragmentation functions, jet splitting functions, other complex jet observables
2025	p+p	High statistics data for Upsilon modifications High statistics data for jet A_{LL}
2026	Au+Au	High statistics data for b-tagged jets and photon-tagged jets High statistics data for jet fragmentation functions, jet splitting functions, other complex jet observables High statistics data for high p_T direct photons High statistics data for Upsilon modifications, including $Y(3S)$ Collective flow of b-quarks (B hadron elliptic flow)