

The High Energy Physics Landscape in 2019

Jesse Thaler



High Energy Physics Advisory Panel, Rockville, MD — May 30, 2019

In Anticipation of Snowmass 2020+

How has the physics landscape changed since 2014?

Are there new opportunities on the horizon/table with significant discovery potential?

Disclaimers: Examples are illustrative, certainly not exhaustive
Apologies if I missed a crucial result/topic

Any opinions are provisional and evolving
Goal is to spark some discussion

How has the physics landscape changed since 2014?

- ▶ Review of HEP Landscape and P5
- ▶ Solidification of SM / Diversification of BSM
- ▶ Progress on All Science Drivers
- ▶ Discovery of Gravitational Waves
(and rise of multi-messenger astrophysics)

The HEP Landscape (Colloquium Edition)

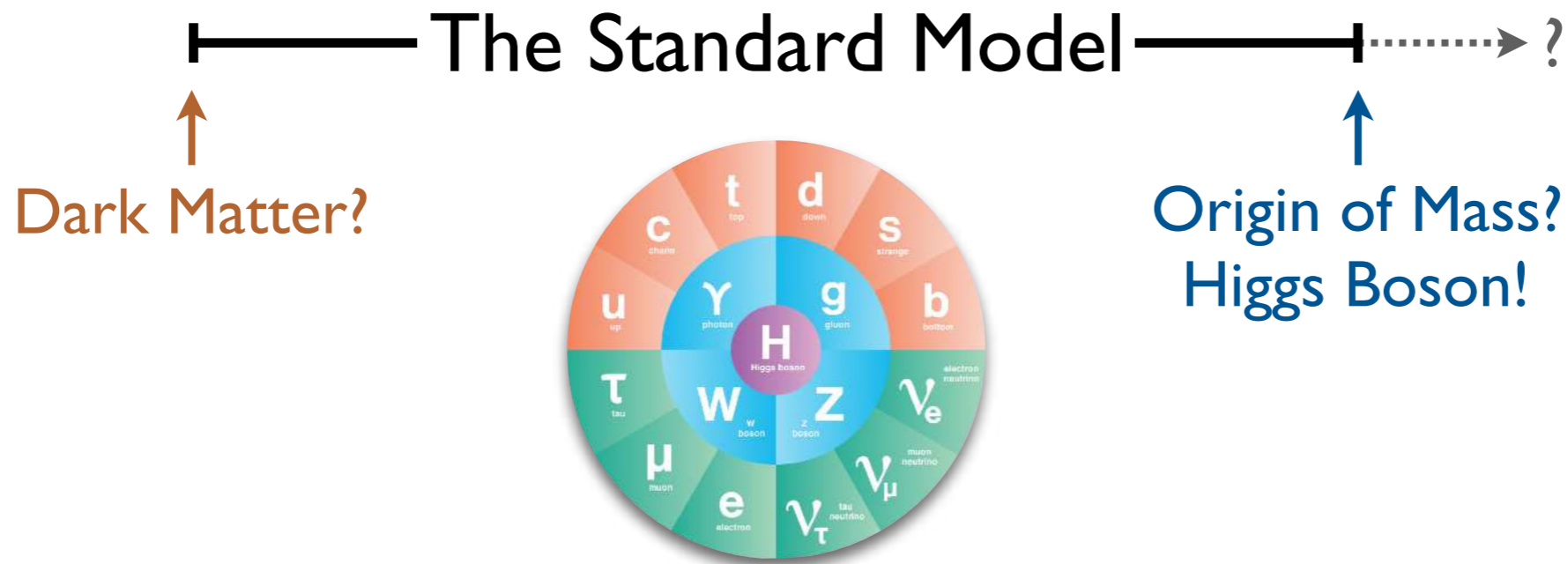
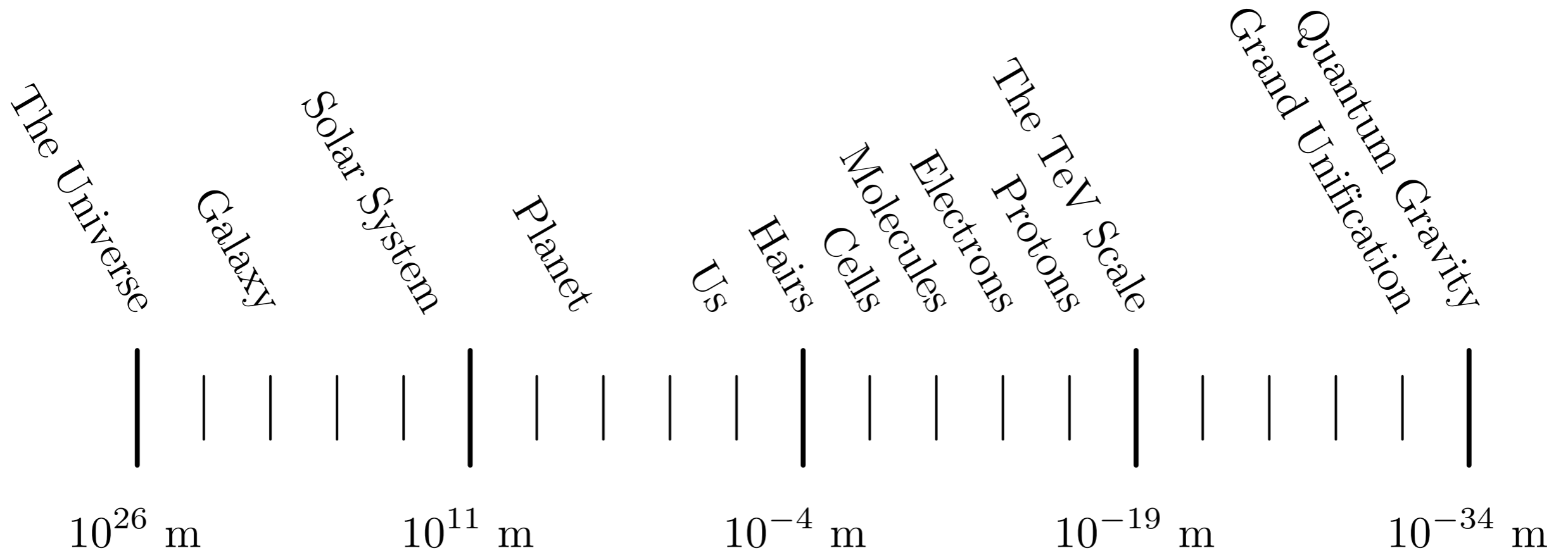

The HEP Landscape *(Colloquium Edition)*

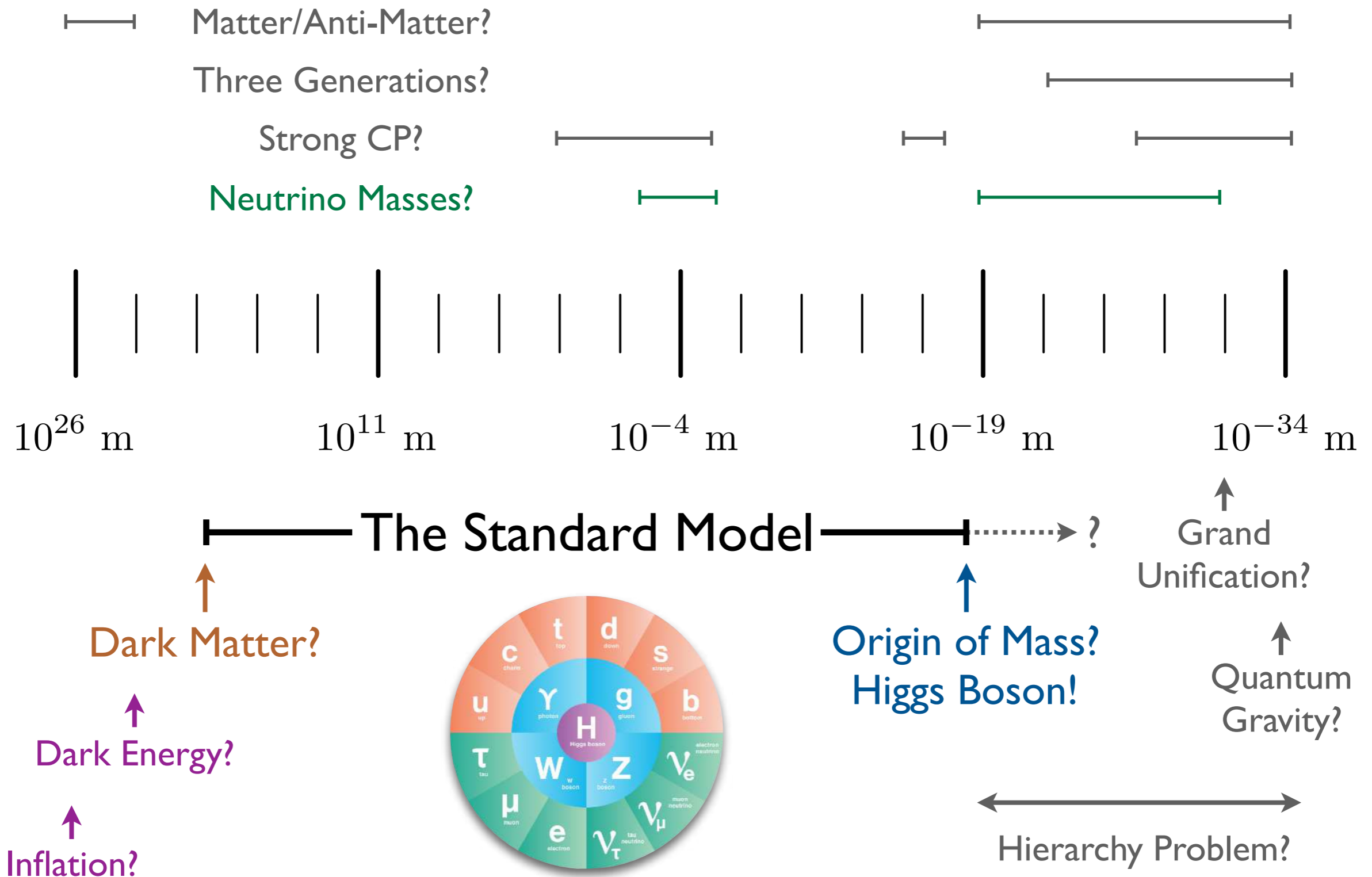

The HEP Landscape (*QFT Edition*)

Standard Model: Leading interactions consistent with these symmetries

$$SU(3)_C \times SU(2)_L \times U(1)_Y$$

$$3 \times \left[q: (\mathbf{3}, \mathbf{2})_{1/6} \quad u^c: (\bar{\mathbf{3}}, \mathbf{1})_{-2/3} \quad d^c: (\bar{\mathbf{3}}, \mathbf{1})_{1/3} \quad \ell: (\mathbf{1}, \mathbf{2})_{-1/2} \quad e^c: (\mathbf{1}, \mathbf{1})_1 \right] \quad h: (\mathbf{1}, \mathbf{2})_{1/2}$$

Principles

Quantum Mechanics
Lorentz/CPT Invariance
Spin/Statistics
Locality/Causality/Unitarity
Global Symmetries*
Conservation Laws
Spontaneous Symmetry Breaking
Gauge Redundancy
Anomaly Cancellation
Renormalization Group Evolution
Effective Field Theory
Naturalness (??)
Weak Gravity / Swampland (??)
...

&

Paradigms

Chiral Mass Generation
Quark Flavor Structure
P/CP Violation
Accidental B, L Conservation
Asymptotic Freedom
(?) Neutrino Mass Generation
(?) Dark Matter
(?) Strong CP
(?) Baryogenesis
(?) Unification
(?) Supersymmetry
(?) Extended Space-time
(?) Inflation
...

2014 Science Drivers from P5

*Well aligned with core questions in fundamental physics
Effective road map through period of transition in US HEP*



- ▶ Use the Higgs boson as a new tool for discovery
- ▶ Pursue the physics associated with neutrino mass
- ▶ Identify the new physics of dark matter
- ▶ Understand cosmic acceleration: dark energy and inflation
- ▶ Explore the unknown: new particles, interactions, and physical principles

2014 Science Drivers from P5'

with apologies to the $B \rightarrow K \mu^+ \mu^-$ anomaly

*Well aligned with core questions in fundamental physics
Effective road map through period of transition in US HEP*



- ▶ Use the Higgs boson as a new tool for discovery
 - ▶ Pursue the physics associated with neutrino mass
 - ▶ Identify the new physics of dark matter
 - ▶ Understand cosmic acceleration: dark energy and inflation
 - ▶ Explore the unknown: new particles, interactions, and physical principles
- ▶ Develop transformative concepts and technologies to enable future discoveries

*In addition to reaping the physics rewards of key investments,
we are continually planting the seeds for future explorations*

[U.S. Particle Physics: Building for Discovery]

2014 → 2019: Solidification of Standard Model

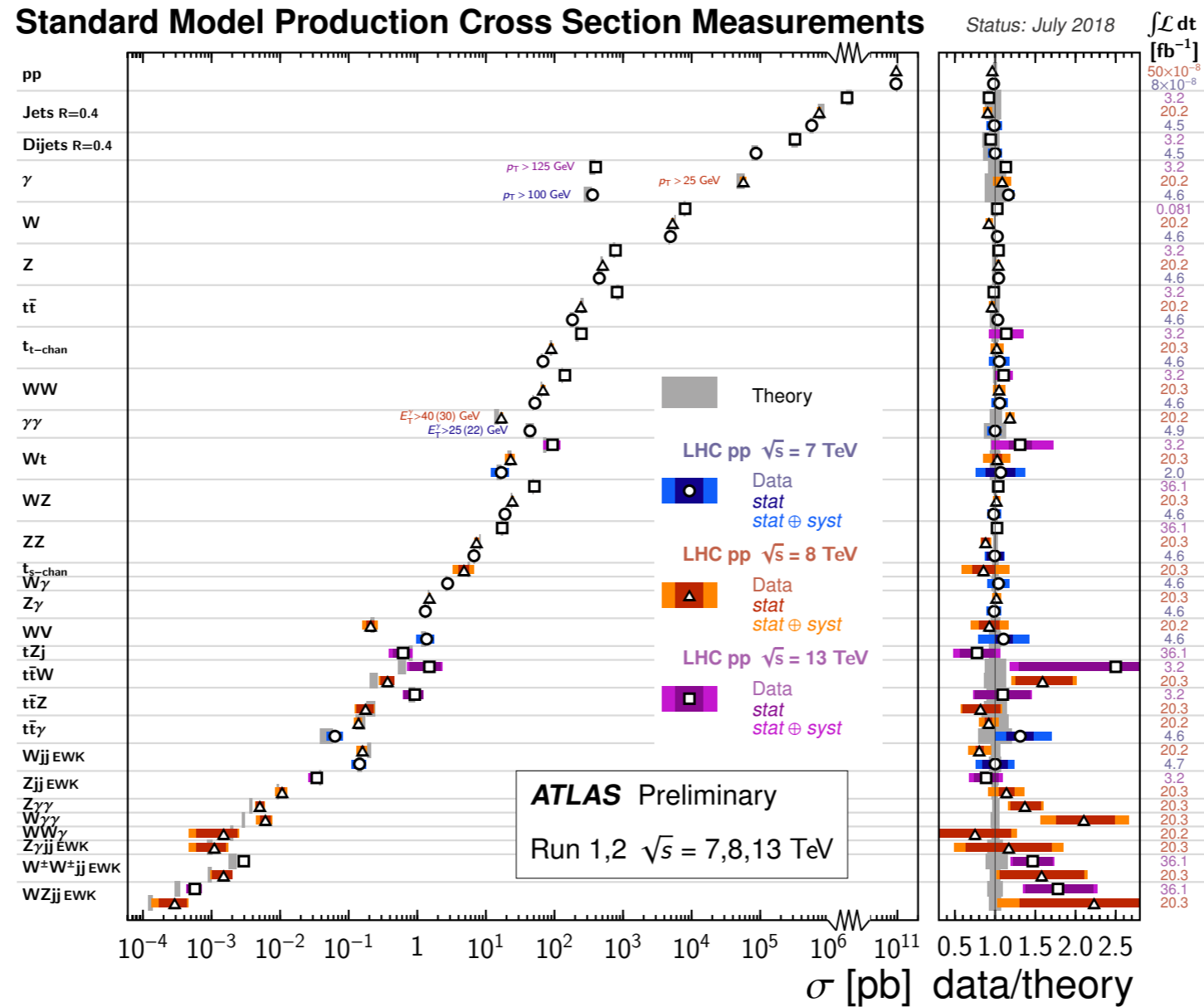

LHC Run 1 & 2: Experimental and theoretical triumph!

(and much more to come with full Run 2 dataset, Run 3, and HL-LHC)

2014 → 2019: Diversification of BSM Searches

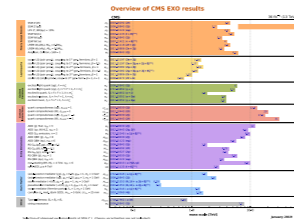

Unpacking one entry in BSM bar chart

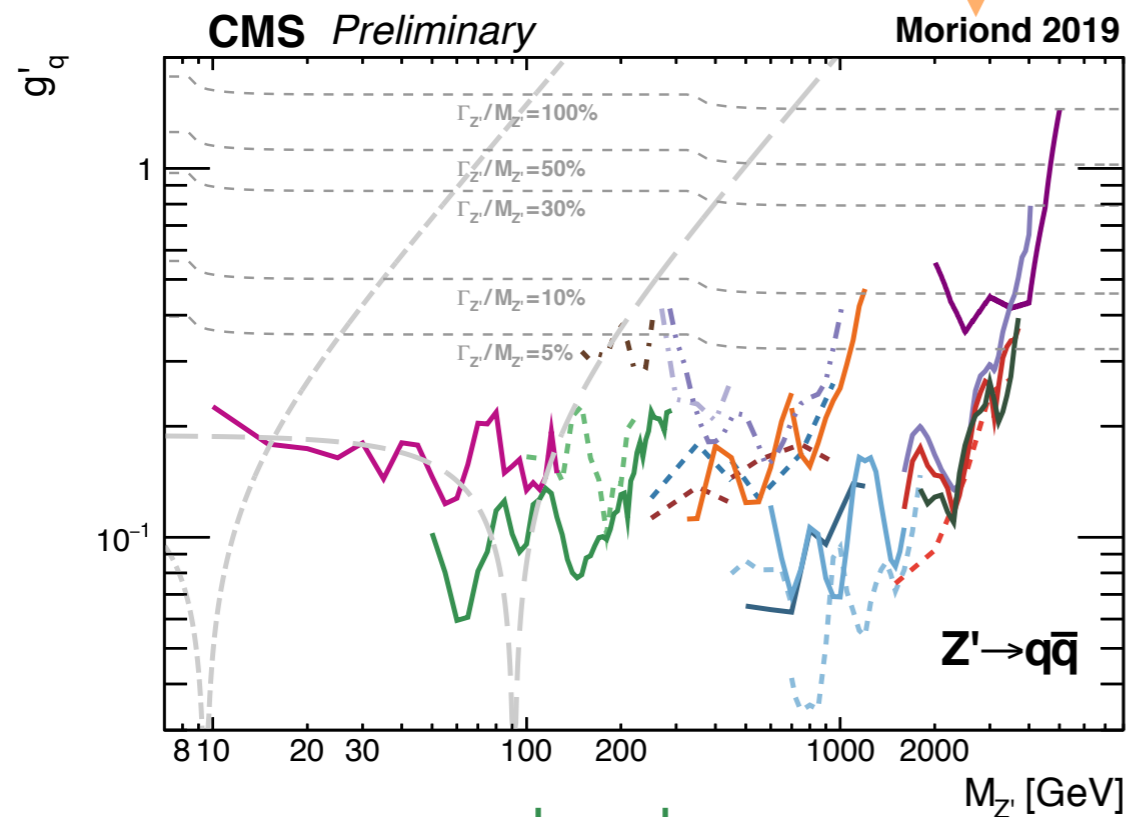
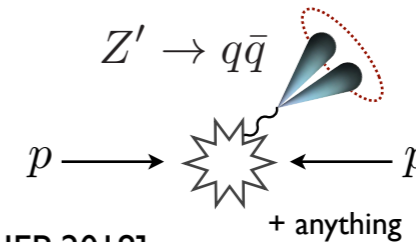

Using substructure techniques invented c. 2014...

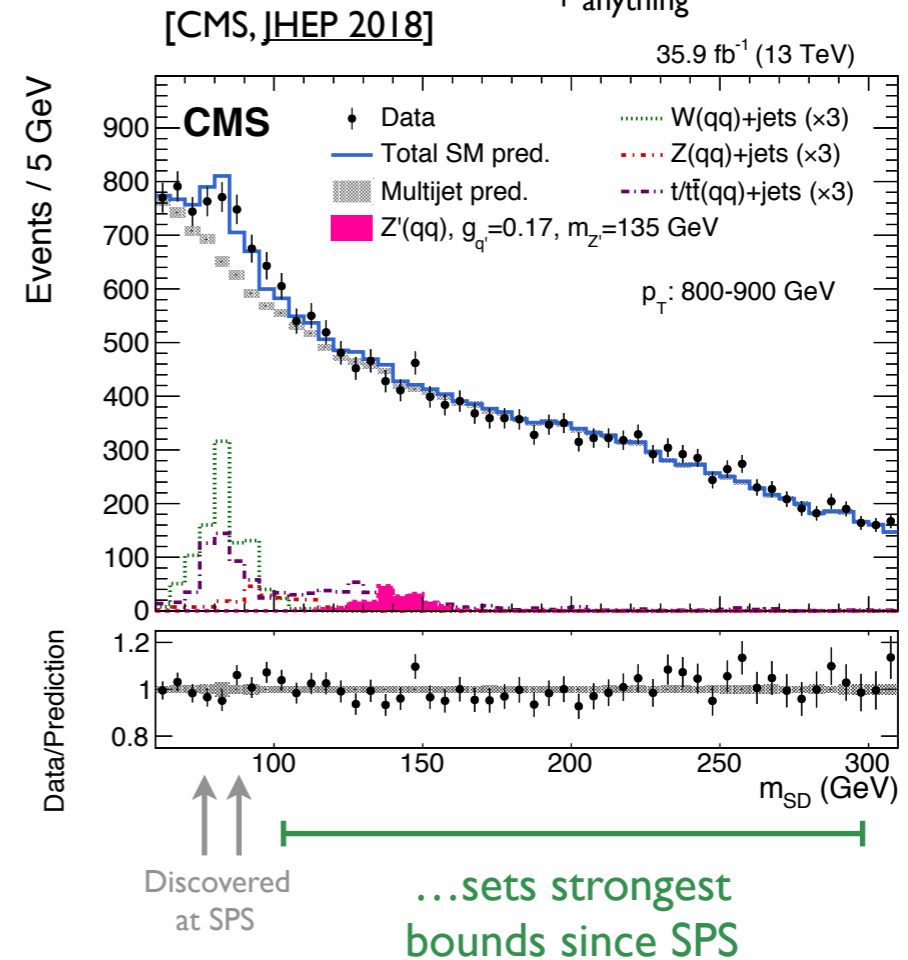

Wide range of innovative analyses with broad coverage!

Backup: Rapid progress using novel reconstruction / deep learning to enhance BSM searches

2014 → 2019: Establishing New Paradigms

Not just a response to null results; broadening in thinking even pre-LHC

Extended Symmetries

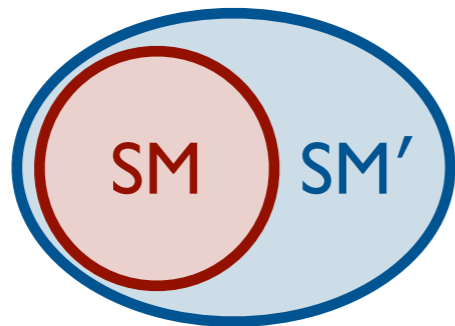

Typical structure to address conceptual shortcomings of SM

e.g. electroweak hierarchy problem
→ softly-broken symmetries
→ TeV-scale partners

Hidden Sectors

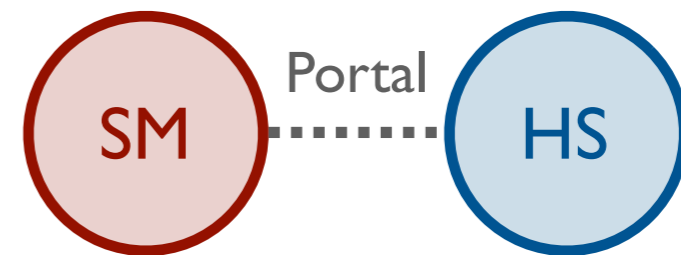

Arguably the generic structure of string-theoretic scenarios

e.g. secluded dark matter
w/ thermal relic abundance
→ dark portal searches

Plus intermediate scenarios: split spectra, neutral naturalness, dynamic relaxation, ...

New paradigms motivate new search strategies

Can often capitalize on investments in existing projects (more later)

2014 → 2019: Continued Effectiveness of EFTs

In the context of effective field theories, we can already...

$$\langle h \rangle = \begin{pmatrix} 0 \\ v/\sqrt{2} \end{pmatrix}$$

- ▶ Describe process of electroweak symmetry breaking
⇒ Higgs mechanism

$$c_{ij} \frac{\ell_i h \ell_j h}{M}$$

- ▶ Accommodate neutrino masses/mixing
⇒ Dimension-5 Weinberg operator (if Majorana)

$$\frac{a}{f} \frac{\alpha_s}{8\pi} G^{\mu\nu a} \tilde{G}_{\mu\nu}^a$$

- ▶ Build testable dark matter paradigms
⇒ e.g. WIMPs, hidden sectors, axions (with strong CP bonus)

$$\Lambda$$

- ▶ Accommodate current acceleration & primordial density fluctuations
⇒ Cosmological constant & single-field inflation

$$\frac{qqq\ell}{M}$$

- ▶ Motivate why further deviations are suppressed
⇒ Approximate symmetries (B, L, CP, GIM, MFV, ...)

$$g_{\mu\nu} = \eta_{\mu\nu} + h_{\mu\nu}$$

- ▶ Quantum-mechanically couple SM to gravity in weak-field limit
⇒ Einstein-Hilbert graviton with one free parameter (M_{Pl})

**Enables systematic probes
for cracks in the SM:**

$$\mathcal{L} = \mathcal{L}_{\text{SM}} + \frac{1}{M} \mathcal{O}_5 + \frac{1}{M^2} \mathcal{O}_6 + \dots$$

Clear Goal for the Foreseeable Future



Go beyond EFT description and understand fundamental dynamics behind these phenomena



Higgs boson

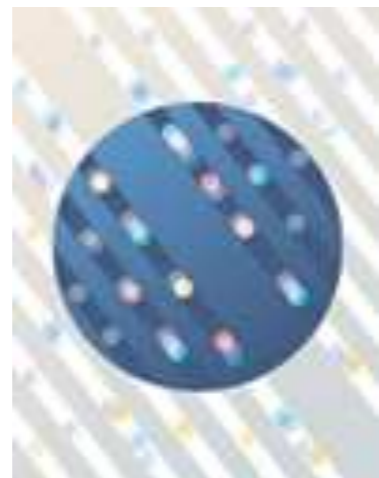

Neutrino mass



Dark matter

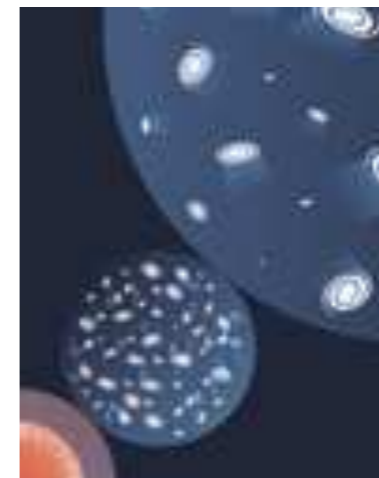

Cosmic acceleration



Explore the unknown

2014 → 2019 → ...

Impressive progress on all science drivers
A few more examples below (not exhaustive; apologies)

P5: Well-defined path going forward

Excellent Accelerator Performance



CERN:

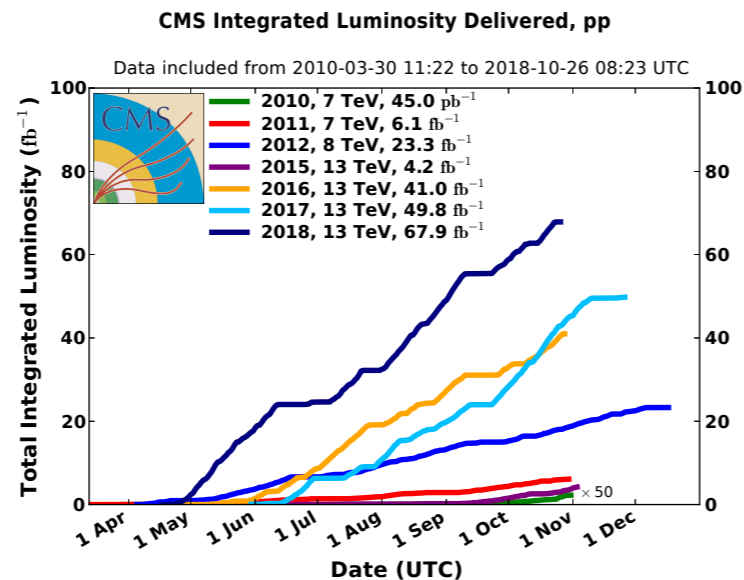

LHC Run 1: $\sim 30 \text{ fb}^{-1}$ @ 7/8 TeV
 \Rightarrow Higgs discovery!

LHC Run 2: $\sim 160 \text{ fb}^{-1}$ @ 13 TeV
 \Rightarrow Significant discovery potential

P5: HL-LHC: 3 ab^{-1} @ 14 TeV
 \Rightarrow Legacy proton-proton dataset

Fermilab: Long Baseline: NUMI \rightarrow NOvA (ν and anti- ν modes)

P5: PIP-II \rightarrow LBNF/DUNE

Short Baseline: Booster Neutrino Beam \rightarrow MicroBooNE

P5: \rightarrow Full SBN with SBND & ICARUS

Muon Program: Delivery Ring \rightarrow g-2 Storage Ring (run 2 underway)

P5: \rightarrow Mu2e

Japan: SuperKEKB \rightarrow Belle II (first collisions April 26, 2018, aiming for 50 ab^{-1})

P5: Participate in possible ILC

Probing the Higgs Sector



Higgs to Heavy Flavor

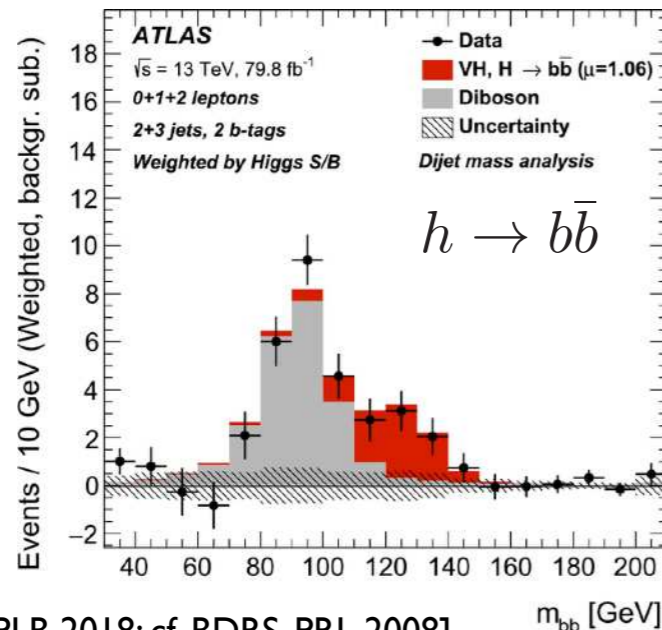

[ATLAS, PLB 2018; cf. BDRS, PRL 2008]

Simultaneous Fit for m_t/α_s /PDF

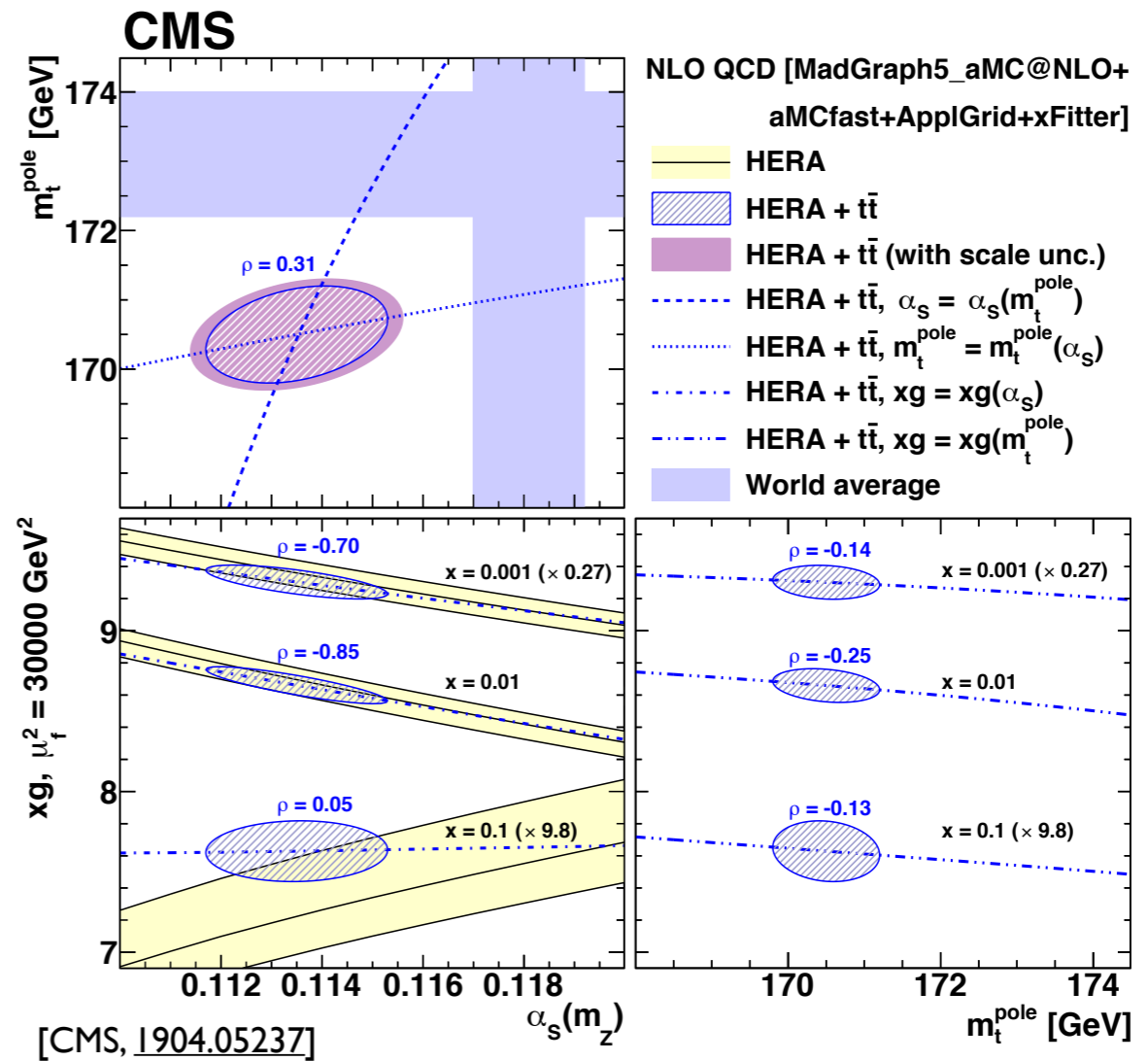

[CMS, 1904.05237]

Precision W Mass in pp

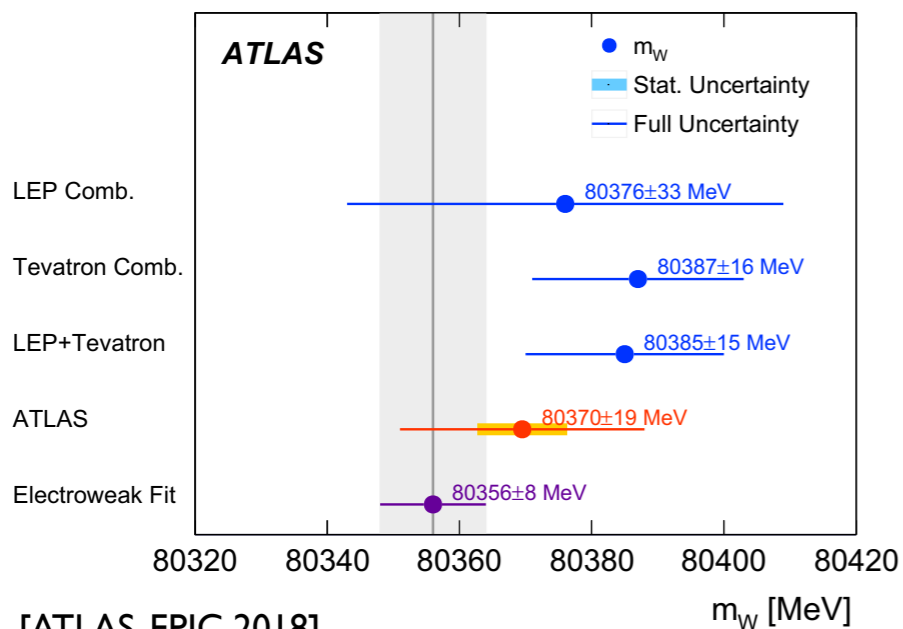

[ATLAS, EPJC 2018]

Remember, precision Higgs physics requires precision top/EW/QCD as well

Probing the Neutrino Sector



Persistent Appearance Excess

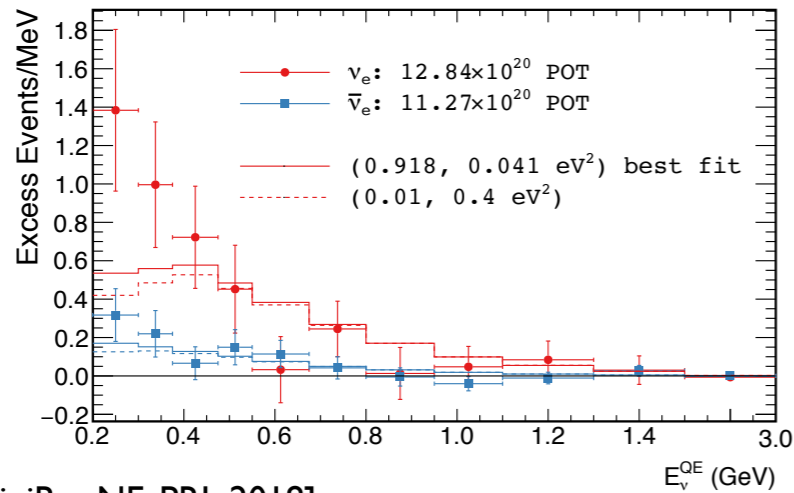

[MiniBooNE, PRL 2018]

Closing in on Mass Ordering & δ_{CP}

With both ν & anti- ν

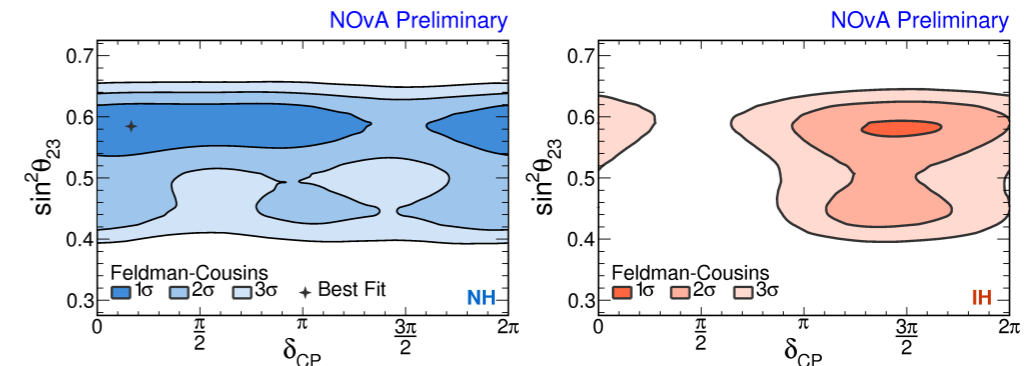

NOvA Preliminary

Pursuing Majorana with $0\nu\beta\beta$

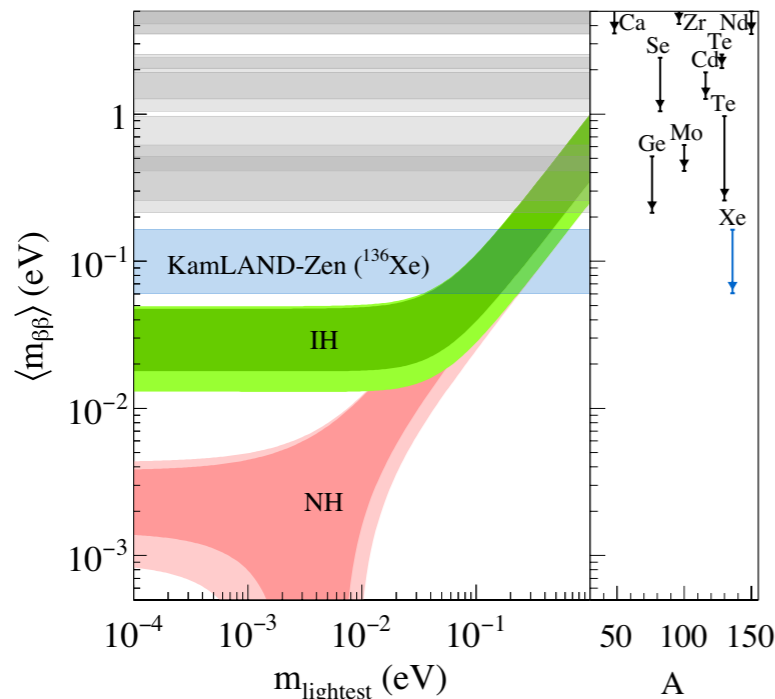

[KamLAND-Zen, PRL 2016]

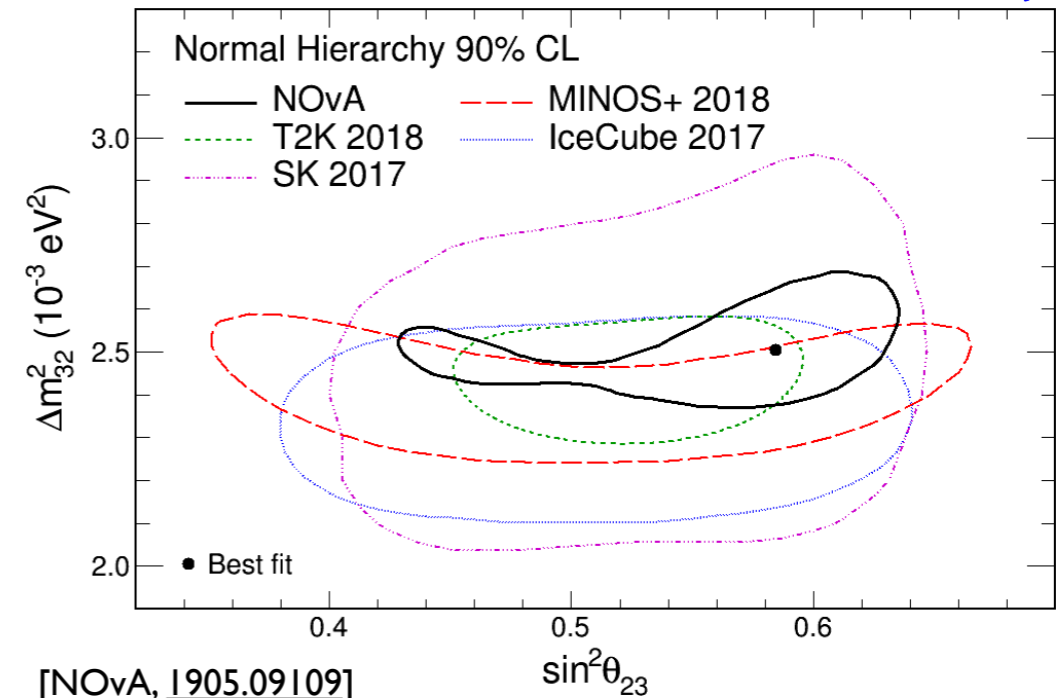

[NOvA, 1905.09109]

Setting the stage for the future long baseline neutrino program

Hunting for Dark Matter



First Results from ADMX-G2

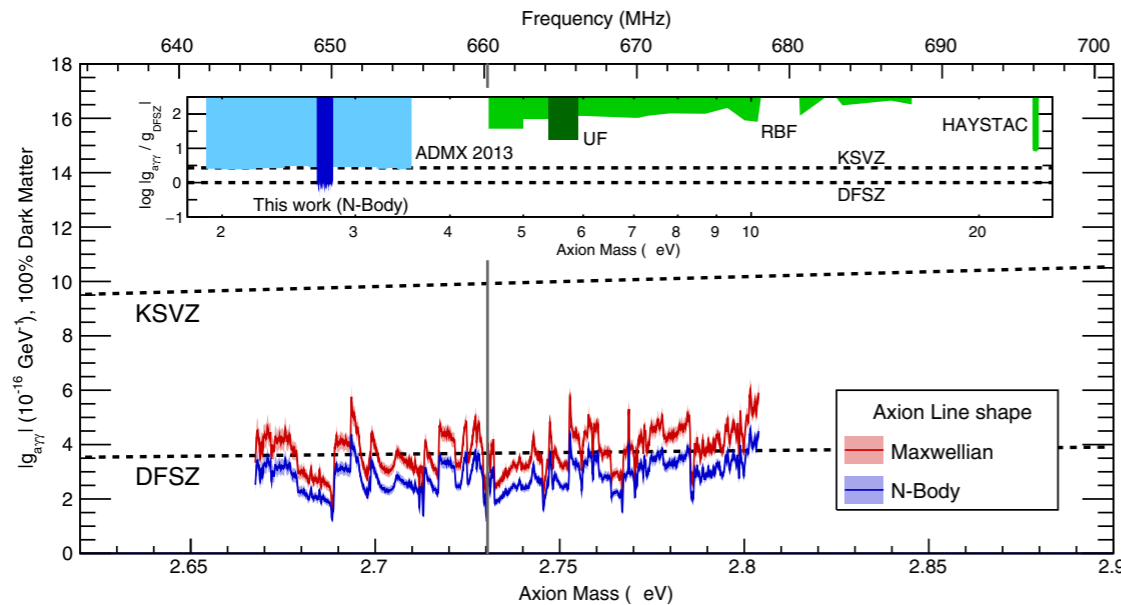

[ADMX, PRL 2018]

WIMP Direct Detection

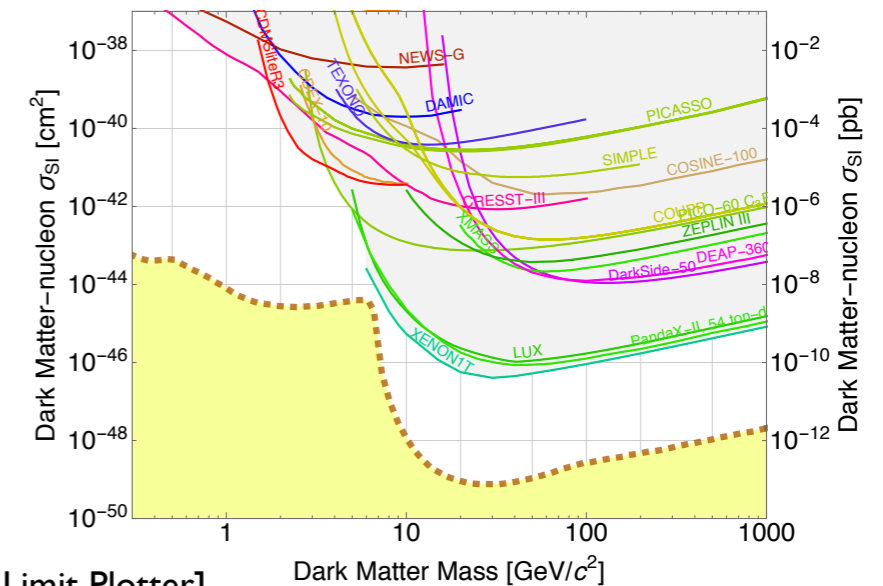

[DM Limit Plotter]

P5: LZ, SuperCDMS-SNOLAB, eventually DM G3

Indirect Detection of Dwarf Galaxies

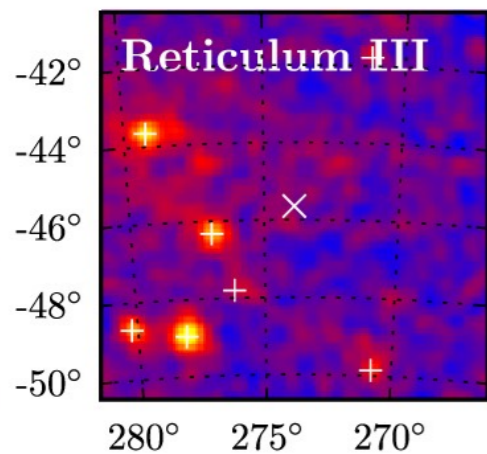

[FERMI-LAT+DES, ApJ 2017]

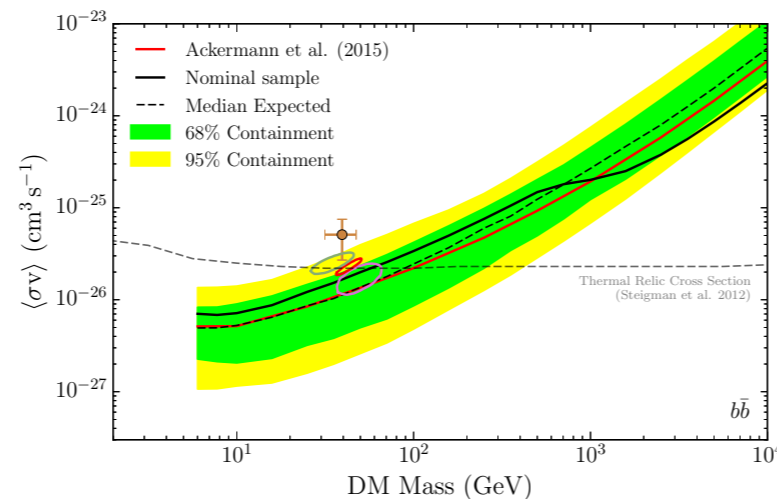

Highlights growing connection between HEP questions and astrophysical observations

Mapping the Cosmos



DES: Supernovae + BAO + Weak Lensing + Galaxy Clustering \Rightarrow **P5: DESI & LSST**

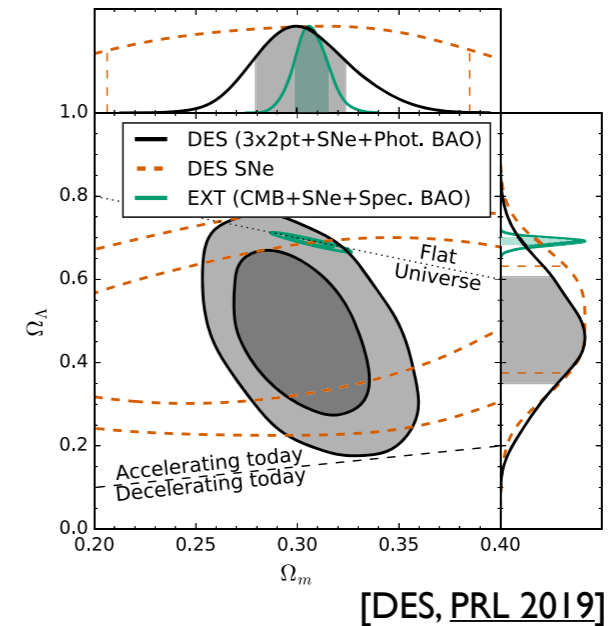
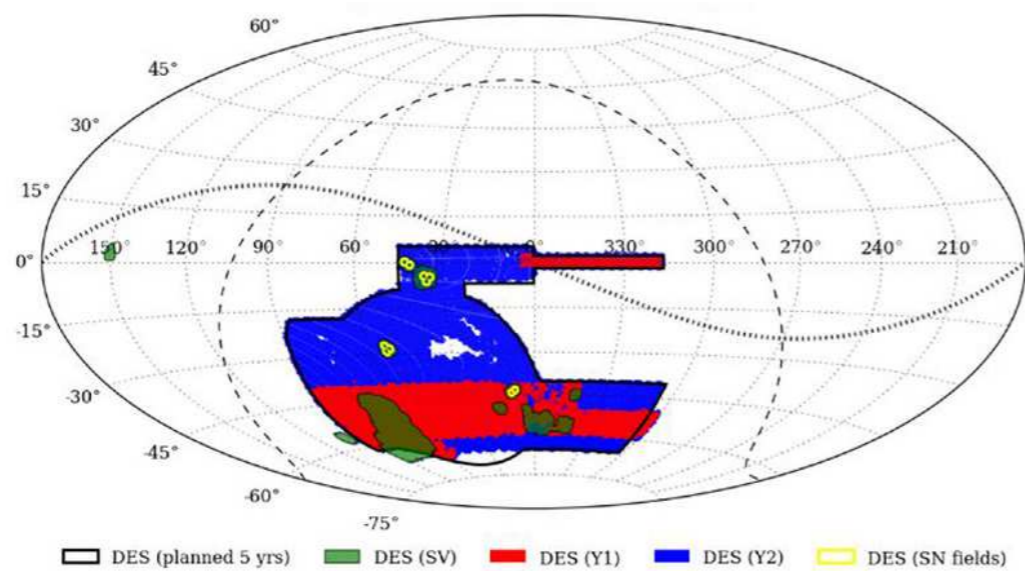

Planck Legacy Archive (July 2018) + S3 \Rightarrow **P5: CMB S4**

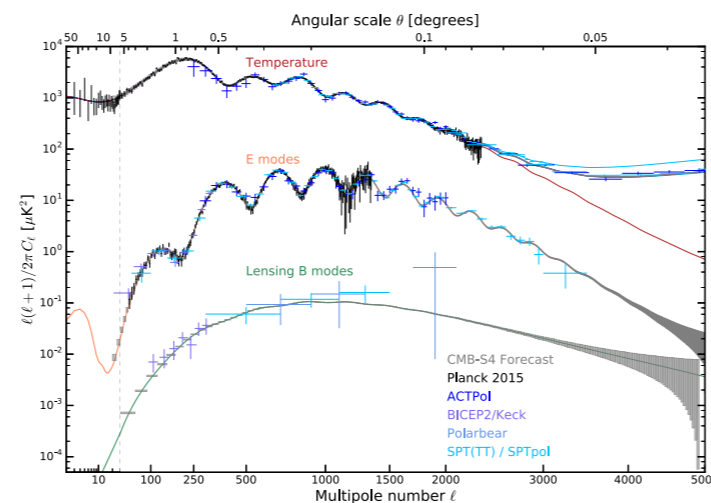
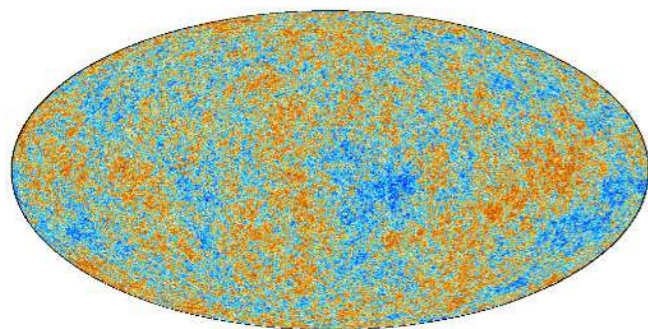

Probes of cosmic acceleration are also crucial probes of neutrinos and dark matter

Reaching into the Unknown



Lepton Universality Violation?

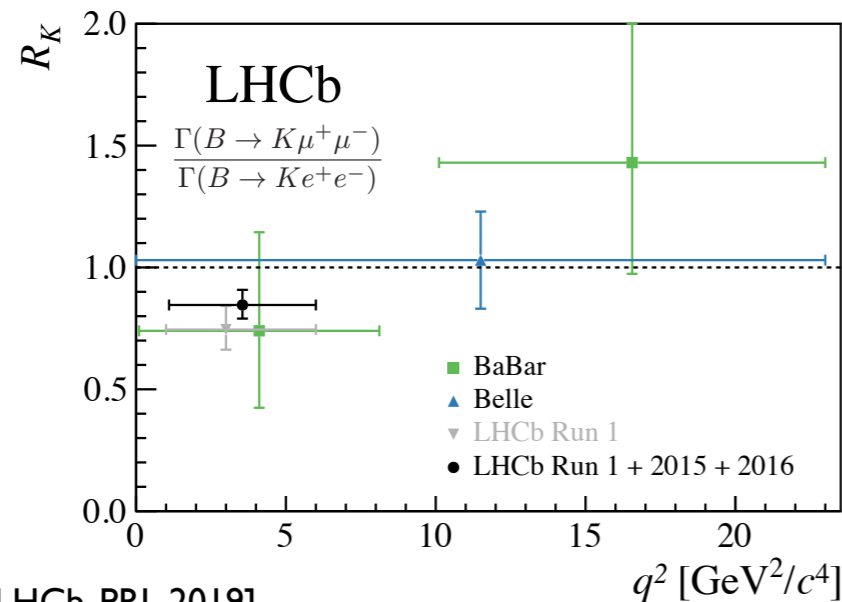

[LHCb, PRL 2019]

Electric Dipole Moments? (not yet)

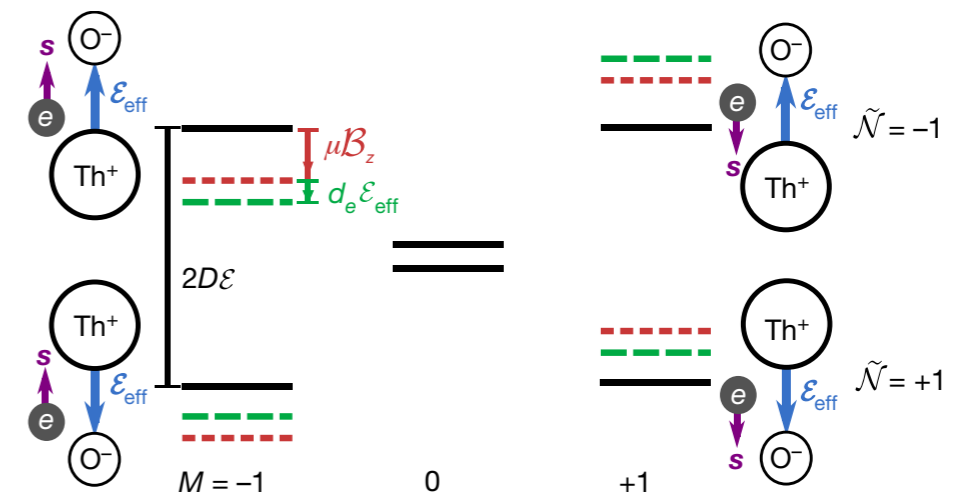

$[|d_e| < 1.1 \times 10^{-29} \text{ e cm, ACME II, Nature 2018}]$

Cosmic Ray Injections?

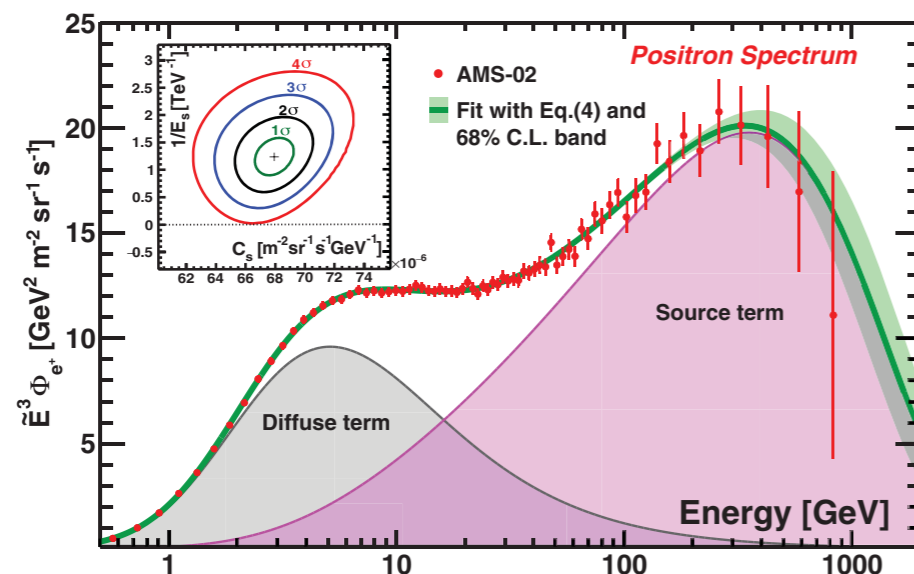

[AMS-02, PRL 2019]

*New physics could show up
in many different places*

*Motivates a diversity of approaches
across a range of scales, and a
persistent pursuit of new paradigms*

Discovery of Gravitational Waves

And the rise of multi-messenger astrophysics



Truly inspiring scientific story!

HEP Connections?

- Primordial Black Holes as Dark Matter
- Standard Sirens for Cosmological Evolution
- Phase Transitions in the Early Universe
- Exotic Compact Objects

...

Likely Needs Broad Frequency Coverage

e.g. PTA, LISA, BBO, DECIGO, MAGIS, ...

Binary Neutron Star Merger

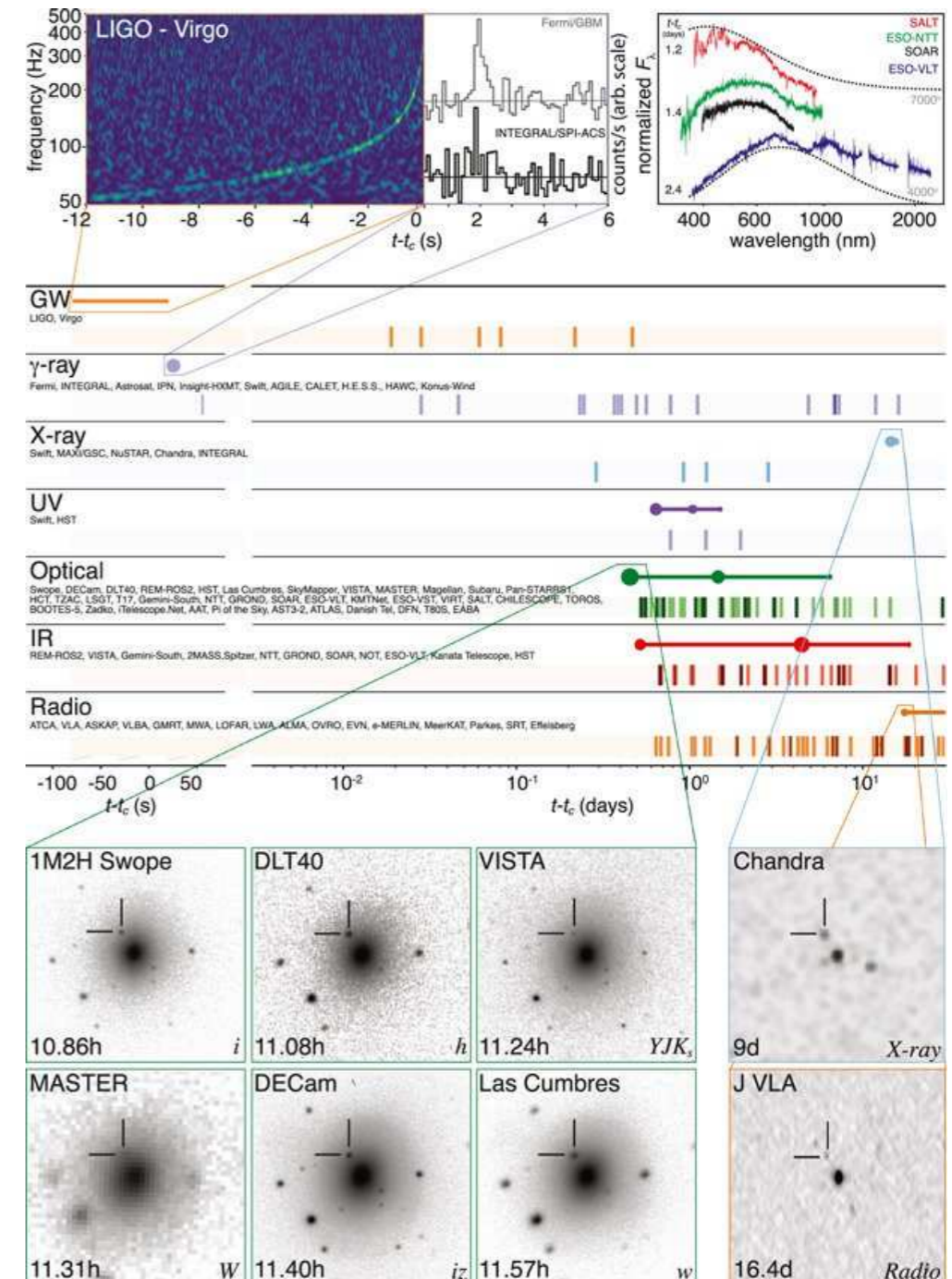

[figure from [GW170817](#); see of course [GW150914](#)]

Are there new opportunities on the horizon/table with significant discovery potential?

- ▶ Setting the Stage for a Higgs Factory
- ▶ New Dark Matter Paradigms
- ▶ Small-Scale Experiments / Curiosity-Driven Research
- ▶ Quantum Information Science

Pushing to the Multi-TeV Scale

Chiral Symmetry Breaking $\xrightarrow{\times 10^3}$ Electroweak Breaking

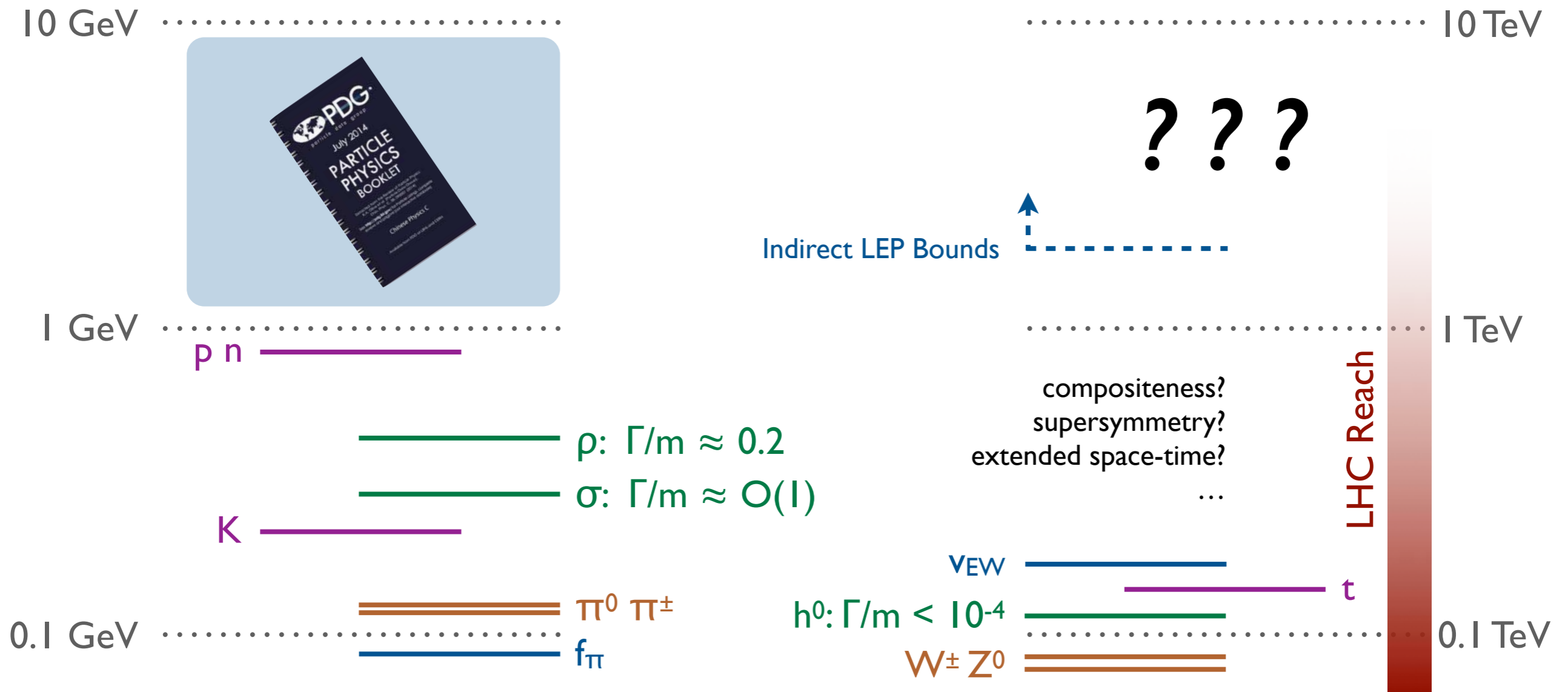

Explorations via Precision Higgs



$$\begin{aligned}
 V(h) = & -m^2 h^\dagger h & + \lambda_h (h^\dagger h)^2 & + |h|^6 ? & + V(h_2, s, \dots) ? \\
 & & \text{Higgs self-coupling} & \text{Higgs compositeness} & \text{extended Higgs sectors} \\
 \mathcal{L} \supset & y_\psi \psi h \psi^c & \times |h|^2 ? & + |h^\dagger D_\mu h|^2 ? & + |h|^2 \mathcal{O}_{\text{BSM}} ? \\
 & & \text{mass/coupling relations} & \text{precision electroweak} & \text{Higgs portal to new physics}
 \end{aligned}$$

Plus electroweak phase transition, new physics in loops, neutral naturalness, vacuum stability...

Deviations $\sim (v/f)^2 \Rightarrow$ Sub-percent accuracy to probe multi-TeV scale

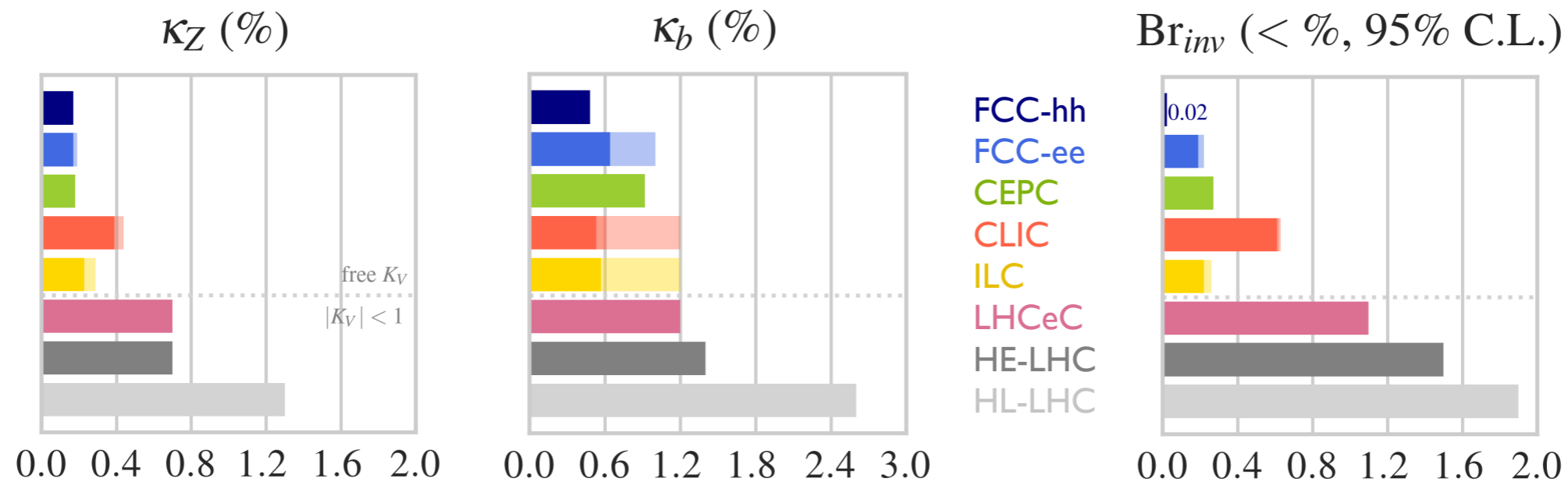

[Higgs at Future Colliders Working Group (2019)]

Setting the Stage for a Higgs Factory



3 ab⁻¹: ~150 million Higgs

Backup: Importance of archiving collider data

Opportunities to further advance Higgs/top/EW/QCD physics:



Opportunities to push energy frontier: HE-LHC, ILC-1000, SPPC, FCC-hh, CLIC-3000, ...

Backup: In the context of the European Strategy Update

What is Dark Matter?



Overwhelming gravitational evidence across multiple space/time scales

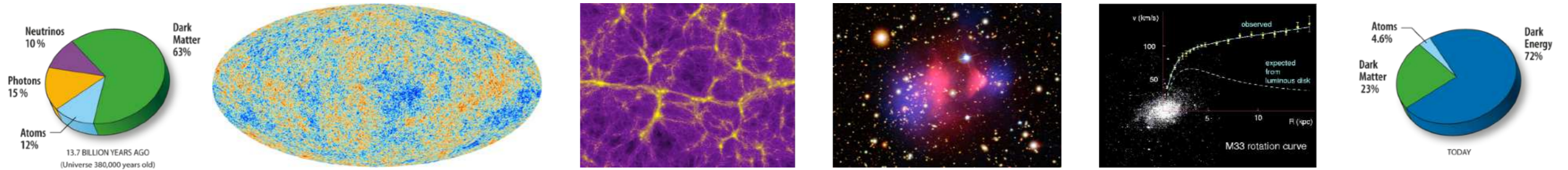

But 36 orders of magnitude of plausible DM masses!

(actually more)

(assuming it even is a particle)

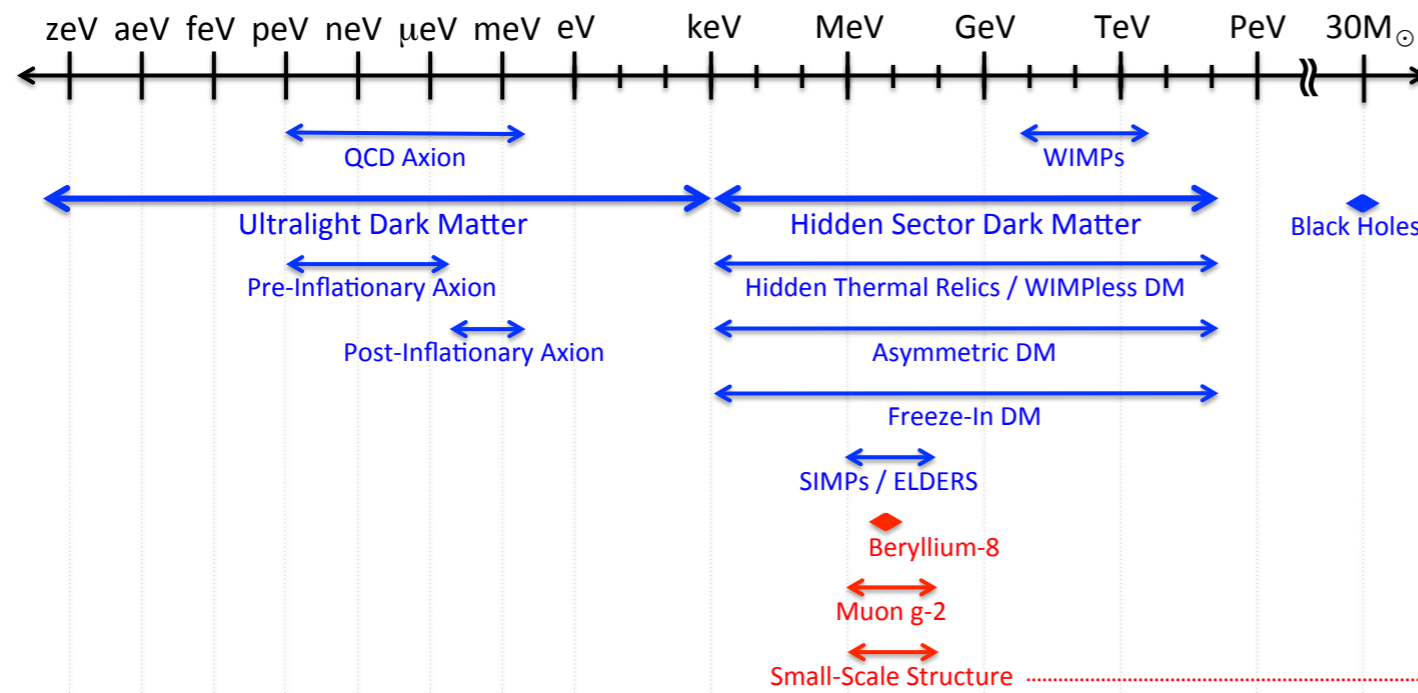

Tantalizing small scale structure anomalies

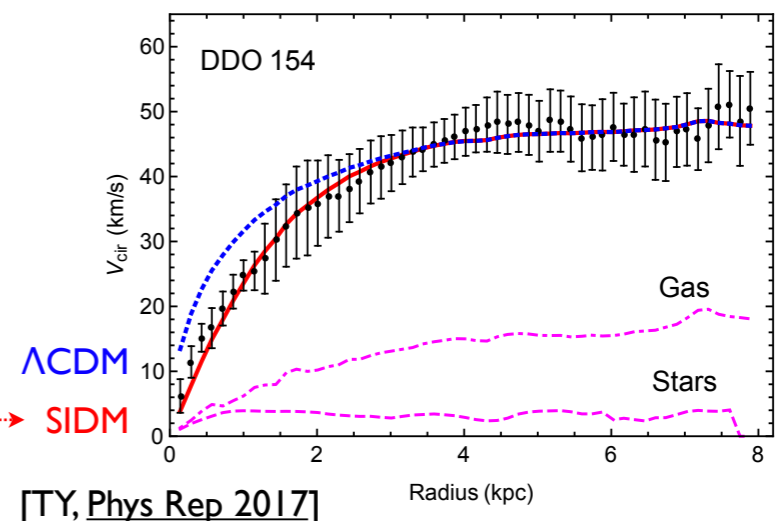

[US Cosmic Visions Community Report (2017)]

[TY, Phys Rep 2017]

New Dark Matter Paradigms



G2 Targets:

WIMP DM

&

QCD Axions

(motivated by thermal freeze out and electroweak hierarchy)

(motivated by strong CP problem)

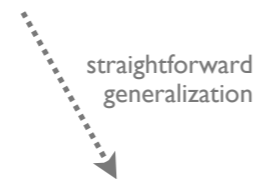

G2' Targets:

Hidden Sector, Asymmetric, Freeze In, SIMPs, Ultralight, ...

(motivated by **consistent cosmological histories** and **tantalizing anomalies**)

Fundamentally, we don't know what DM is, but we have a growing catalog of well-motivated targets

Natural extension of three-prong strategy:

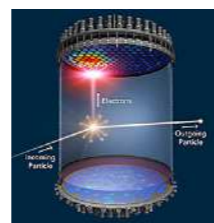

Direct Detection

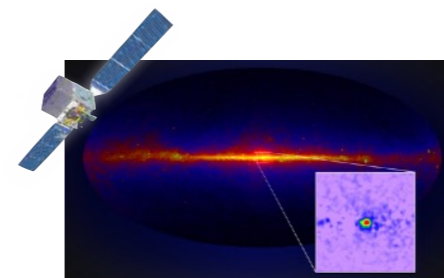

Indirect Detection

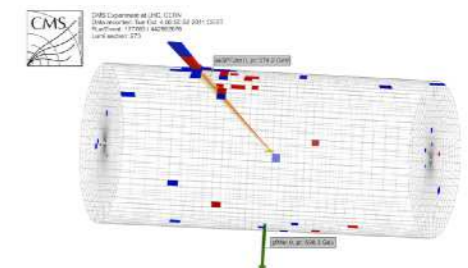

Collider Production

G2': New Experimental Targets

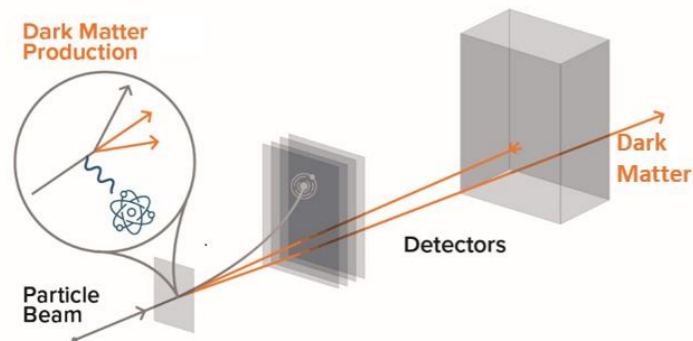

Production/Detection Experiments
(make dark matter beams)

Neutrino connections



Low Threshold Direct Detection
(sub-GeV dark matter)

QIS connections

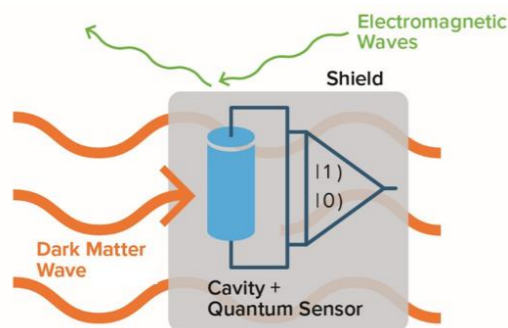

Ultralight Dark Matter Detection
(sub-eV coherent fields)

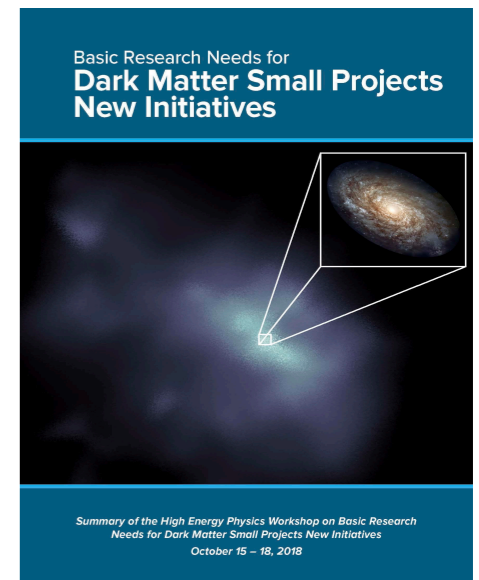

*Dark matter is becoming
a defining question for
my HEP generation*

Broader lessons: Small-scale experiments, curiosity-driven research

A Big Role for Small-Scale Experiments



e.g. Searches for Ultralight Axion-like Dark Matter

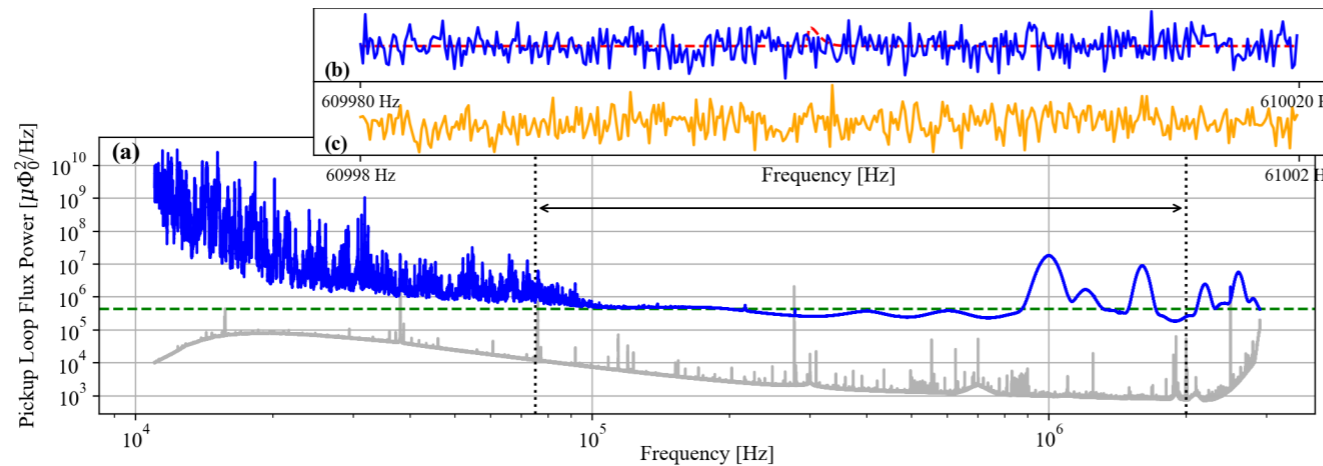

[ABRACADABRA-10cm, PRL 2019]

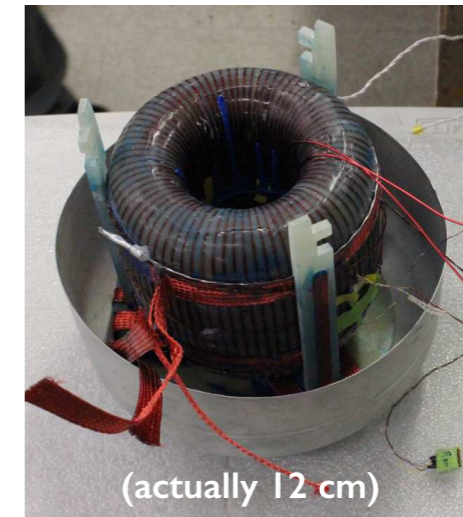

e.g. Coherent Elastic Neutrino-Nucleus Scattering (CEvNS)

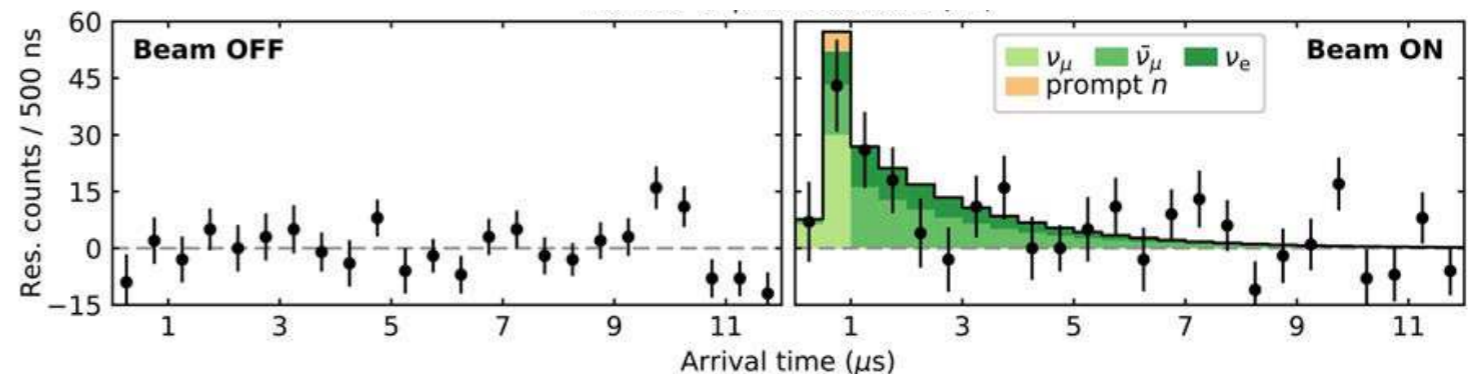
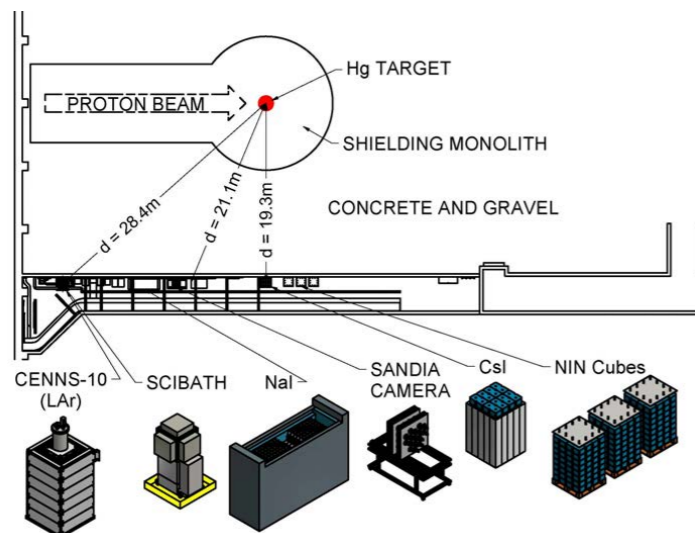

[COHERENT @ SNS, Science 2017; cf. Freedman, PRD 1974]

“Put the detector where the accelerator is”
(cf. IsoDAR: “Put the accelerator where the detector is”)

[see also [Physics Beyond Colliders at CERN](#);
“Table Top Experiments with Skyscraper Reach”, [MIT, August 2017](#)]



Impact of Curiosity-Driven Research

e.g. Paraphotons anticipating Dark Photons, Hidden Sectors

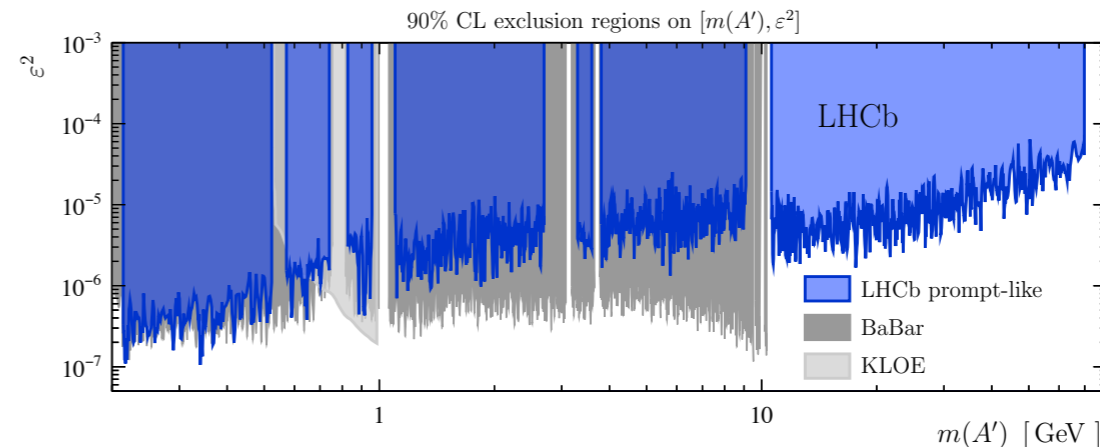
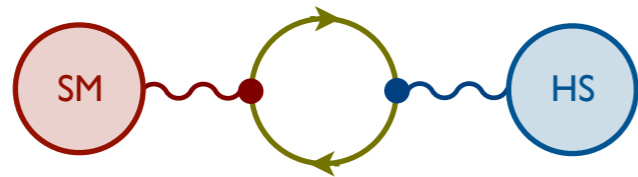

[Okun, JETP 1982; see also Gallison, Manohar, PLB 1984; Holdom, PLB 1986 ⇒ PRV, PLB 2008; AFSW, PRD 2009 ⇒ BEST, PRD 2009 ⇒ ... ⇒ LHCb, PRL 2018]

e.g. Integration By Parts for N³LO Higgs Cross Section

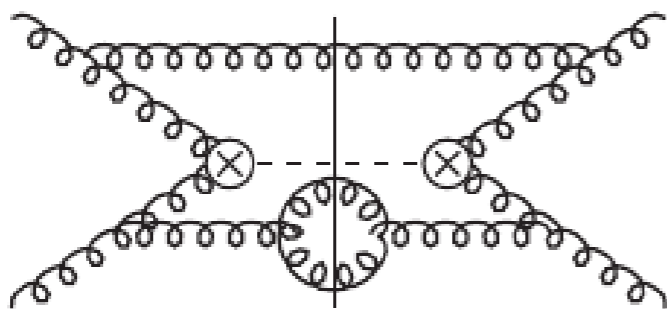

[Tkachov, PLB 1981; + Chetyrkin, NPB 1981 ⇒ ADDHM, PRL 2015]

e.g. Lattice Gauge Theory for Precision Flavor Physics

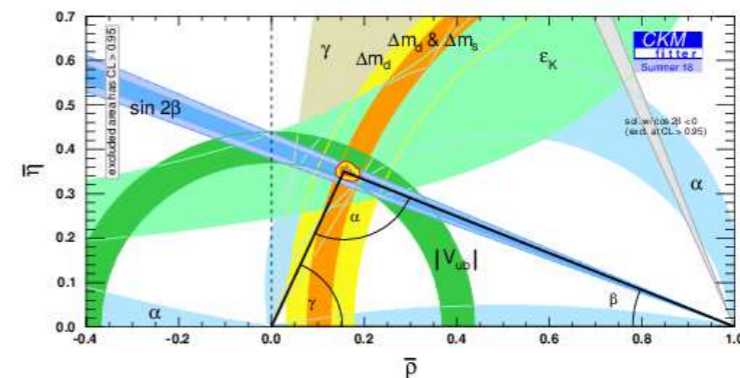

[Wilson, PRD 1974 ⇒ ... ⇒ CKM Fitter]

In both theory and experiment, big ideas start small

Highlighting Theory and R&D (and QIS)



- ▶ Develop transformative concepts and technologies to enable future discoveries

My wording

Official wording

The particle physics theory community will continue to play key roles interpreting results from current experiments, motivating future experiments, and pursuing answers to the deepest questions.

U.S. researchers are pursuing R&D on advanced technologies to enable future generations of accelerators and detectors with a wide variety of applications.

Theoretical and experimental particle physicists are advancing Quantum Information Science (QIS), providing solutions to problems in computation, data analysis, sensors, and simulations.

Also, important R&D efforts in classical software and computing, including machine learning

Basic research helps drive progress on the science drivers

[from [2019 Particle Physics Progress and Priorities](#)]

HEP and the National Quantum Initiative



Quantum: Manipulating individual quantum states
Using superposition, entanglement, squeezing, etc.

Already developing/exploiting Quantum Sensing technologies

Transition Edge Sensors

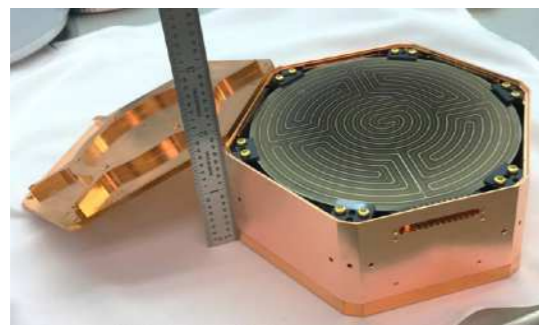

[SuperCDMS]

Atom Interferometry

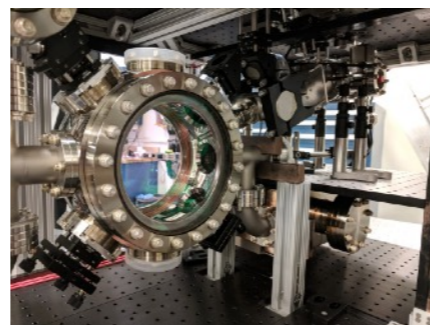

[MAGIS-100]

Microwave SQUID Multiplexers

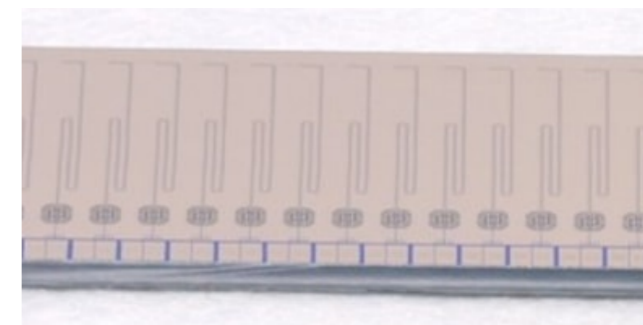

[Simons Observatory]

Squeezed State Receivers

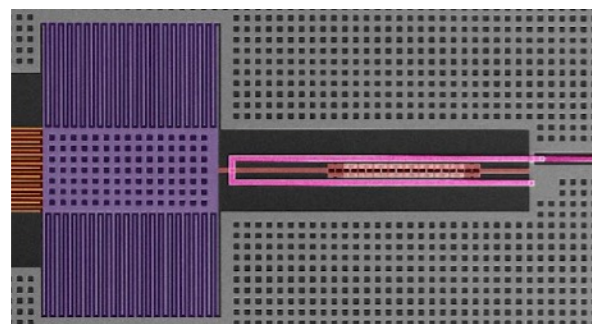

[HAYSTAC]

Skipper CCDs

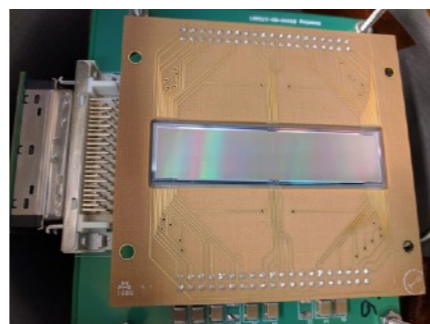

[SENSEI]

And More!

*NMR, superfluid helium,
graphene, atomic clocks,
cold atoms, ...*

[see [Nov 2018 HEPAP Meeting](#);
[Quantum Sensing for HEP \(2018\)](#); [2019 Kavli ACP Workshop](#), [Intersections QIS/HEP](#)]

HEP and the National Quantum Initiative



Quantum: Manipulating individual quantum states
Using superposition, entanglement, squeezing, etc.

Fertile intersection between HEP and QIS
Potentially transformative, requires robust theory/R&D effort

Entanglement \Leftrightarrow Geometry

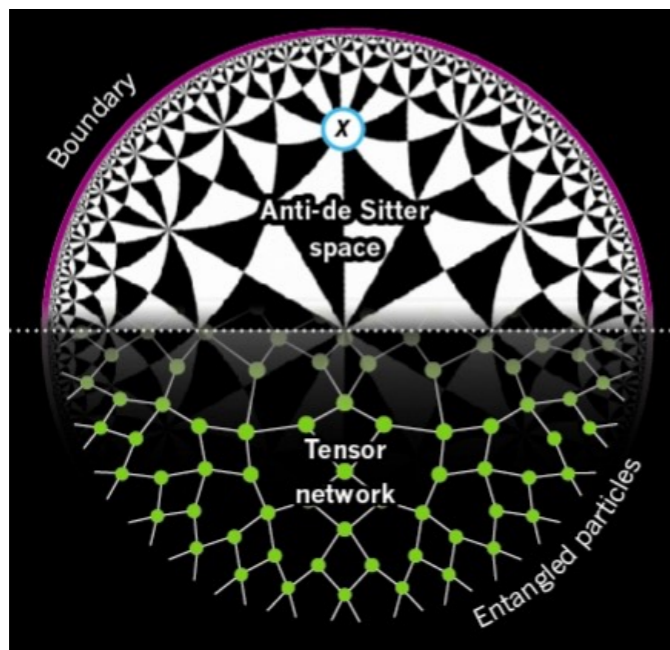

[figure from [Nature 2015](#)]

Simulation

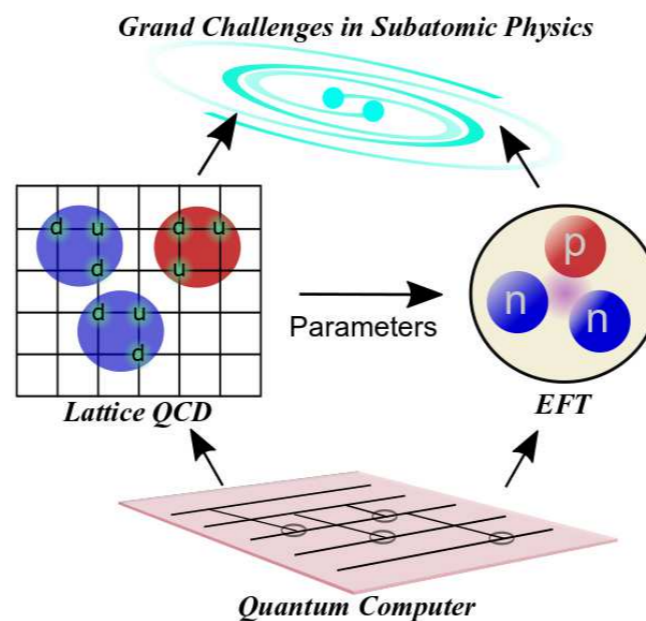

[figure from [1810.03959](#)]

Computation/Analysis

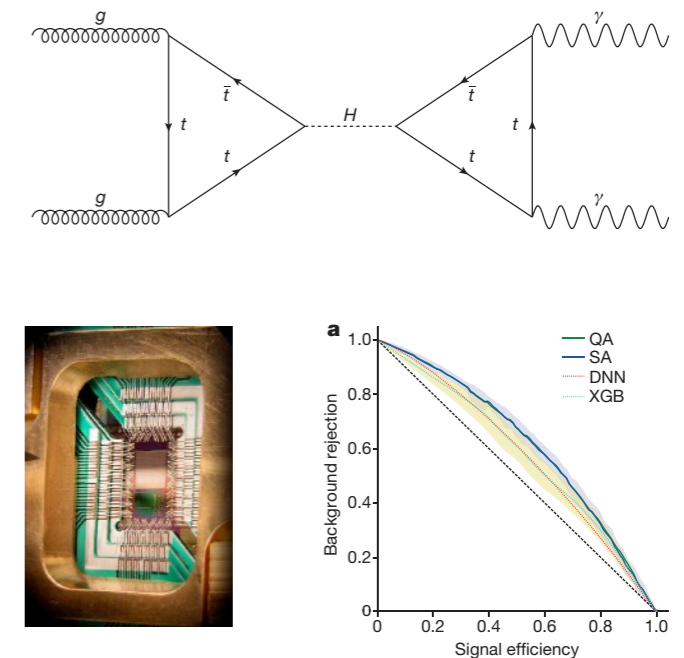

[[MJVLS, Nature 2017](#)]

Final Comments

- ▶ Looking Towards Snowmass 2020+
- ▶ Cultivate a Vibrant, Inclusive HEP Community
- ▶ Summary of Topics

Looking Towards Snowmass 2020+

*The physics priorities of our field are largely the same,
but the toolbox and targets have expanded*



- ▶ Use the Higgs boson as a new tool for discovery
 - ▶ Pursue the physics associated with neutrino mass
 - ▶ Identify the new physics of dark matter
 - ▶ Understand cosmic acceleration: dark energy and inflation
 - ▶ Explore the unknown: new particles, interactions, and physical principles
- ▶ Develop transformative concepts and technologies to enable future discoveries

Looking Towards Snowmass 2020+

*The physics priorities of our field are largely the same,
but the toolbox and targets have expanded*



- ▶ Use the Higgs boson as a new tool for discovery
 - ▶ Pursue the physics associated with neutrino mass
 - ▶ Identify the new physics of dark matter
 - ▶ Understand cosmic acceleration: dark energy and inflation
 - ▶ Explore the unknown: new particles, interactions, and physical principles
-
- ▶ Develop transformative concepts and technologies to enable future discoveries
 - ▶ Cultivate a vibrant, inclusive, and supportive scientific community

*The success of our endeavors depends on “ 4π coverage”
in identifying and cultivating talent at all career stages*

Backup: Example of MIT Physics Community Values



Summary of Topics

How has the physics landscape changed since 2014?

- ▶ Review of HEP Landscape and P5
- ▶ Solidification of SM / Diversification of BSM
- ▶ Progress on All Science Drivers
- ▶ Discovery of Gravitational Waves (and rise of multi-messenger astrophysics)

New opportunities with significant discovery potential?

- ▶ Setting the Stage for a Higgs Factory
- ▶ New Dark Matter Paradigms
- ▶ Small-Scale Experiments / Curiosity-Driven Research
- ▶ Quantum Information Science

Additional topics in backup:

- ▶ Physics Community Values
- ▶ Novel Reconstruction / Deep Learning
- ▶ Archival Collider Data
- ▶ Relevance of HEP to Society
- ▶ European Strategy Update

Inevitably, I have forgotten something important. Looking forward to *full* community input at Snowmass 2020+!

Backup Topics

- ▶ Physics Community Values
- ▶ Novel Reconstruction / Deep Learning
- ▶ Archival Collider Data
- ▶ Relevance of HEP to Society
- ▶ European Strategy Update

MIT Physics Community Values

Towards a more vibrant, inclusive, and supportive scientific community

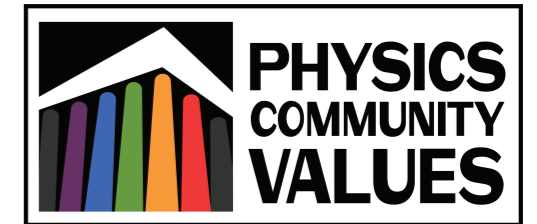

Well-being

We support each other at all times and remember that we are not alone.



Respect

We value the multitude of ways to be a physicist and the many paths through our field and Department.



Inclusion

We strive to speak and act in ways that support and include all members of our community.



Collaboration

Physics is a social endeavor and we proudly collaborate with others to advance the field.



Mentorship

All physicists are here because of the mentorship we have received and continue to receive, and the mentorship we offer to others.



[MIT Physics Community Values, including input from my former undergraduate students Eleanor Hall and Radha Mastandrea; see also [Fermilab Statement of Community Standards](#), [CERN Code of Conduct](#), [Code of Conduct for APS Meetings](#)]

Novel Reconstruction Strategies

Exotic objects, rare phenomena, extreme phase space, anomaly detection, ...

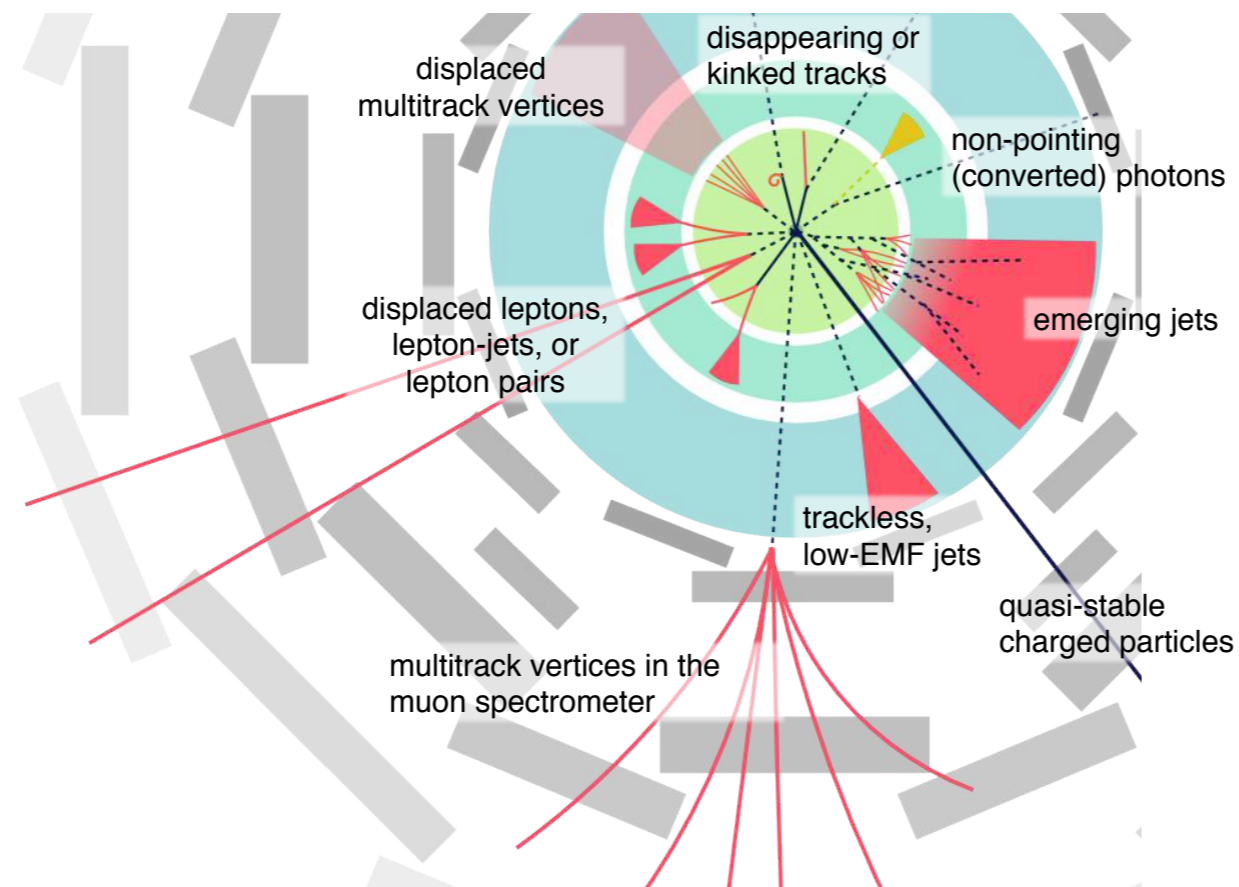

Plausible BSM scenarios that would be missed (or even vetoed) by standard quality cuts

Motivates collider add-ons for long-lived particles: FASER, CODEX-b, MATHUSLA, milliQan, ...

Also motivates new fixed target experiments: HPS, BDX, LDMX, SeaQuest, SHiP, ...

LHC Run 3 / HL-LHC: Natural shift to “signal-limited” BSM searches where significance can grow faster than $\sqrt{\text{luminosity}}$

[see e.g. [LHC Long-Lived Particle Community Report \(2019\)](#)]

The Rise of Deep Learning

Cartoon of Machine Learning: Optimize over examples to define functions



Extensively applied in HEP for decades (e.g. Boosted Decision Trees)

New Opportunity: “Deep” architectures with improved performance, faster training, built-in symmetries, and industry backing

Key Challenges: Validation, calibration, interpretation, visualization

[see e.g. [Machine Learning in HEP Community White Paper \(2018\)](#)]

Examples of Machine Learning in HEP

CMS: $Z \rightarrow e^+e^-$ calibration

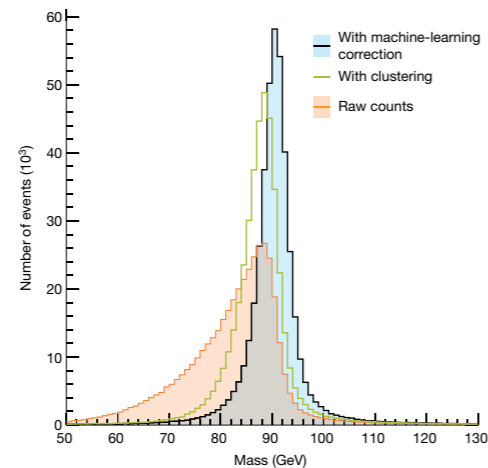

MicroBooNE: Object Identification

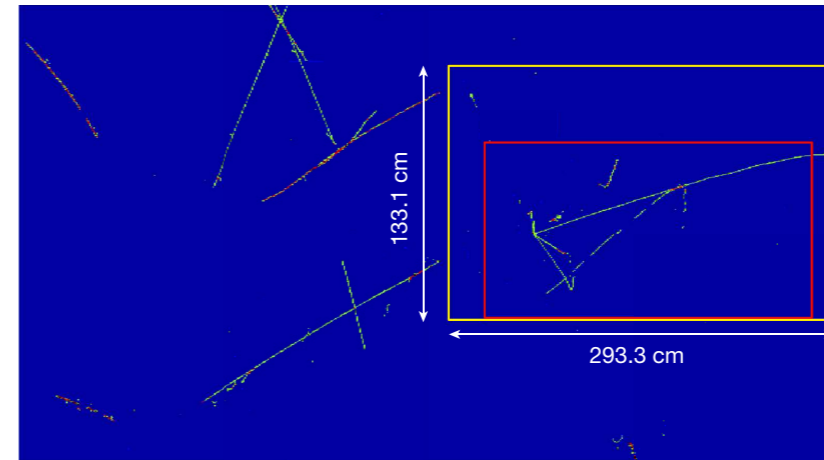

ATLAS: $H \rightarrow \mu^+\mu^-$ search

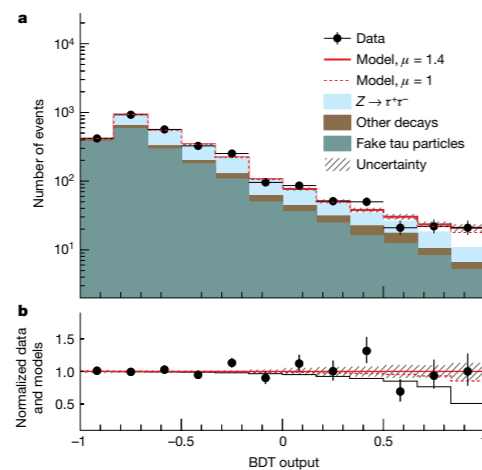

NOvA: Object Classification

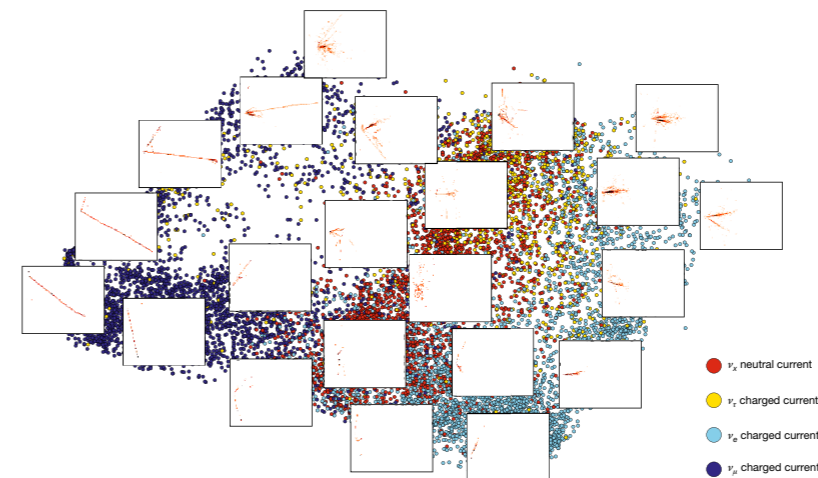

*Area of rapid development, directly relevant to P5 science drivers
Opportunity to engage with partners in industry*

[figures from [Nature 2018](#)]

Longterm Relevance of HEP Data

e.g. *ALEPH reanalysis confronts CMS ridge*

1990–95 e^+e^- data



2010 pp surprise!

2018 e^+e^- analysis

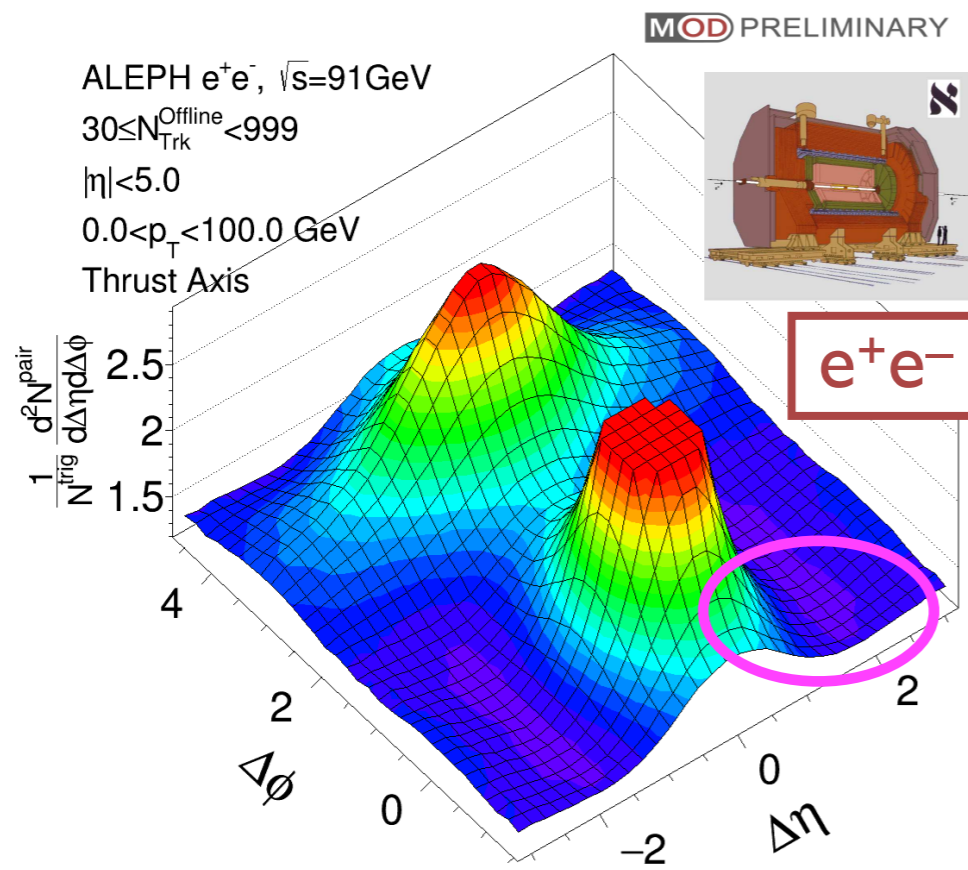

VS.

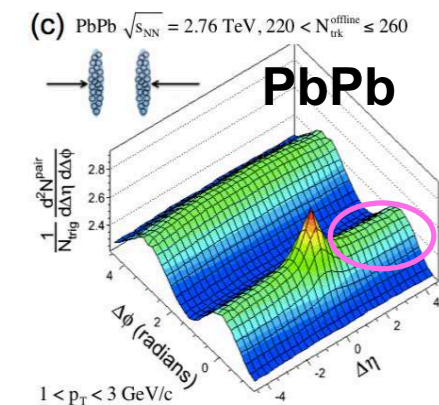
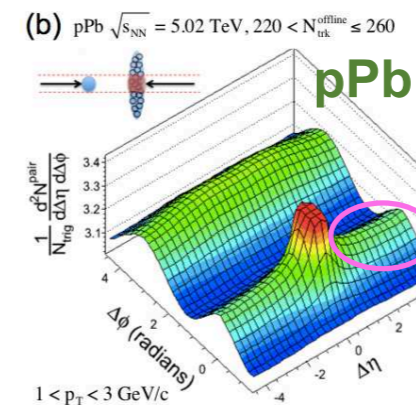
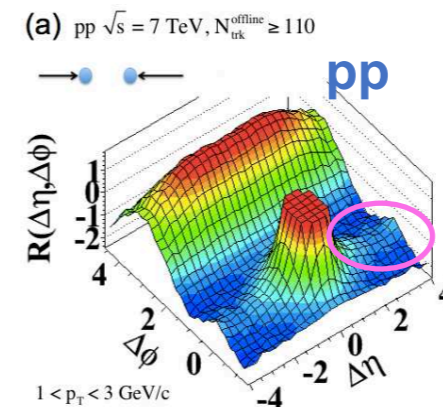

[LBBMITPSCM, NPA 2019]

Pathway to Archival Collider Data?

Examples of archiving via public access: Planck, Fermi, LIGO/Virgo, ...

*Nov 2014: First public release of **research-grade** collider data:*

CERN Open Data Portal:
CMS 2010–2012 (and Opera)



Essential: Ample time delay to avoid competing with collaboration needs

Benefits: Stress-tests archival data strategies
Enables exploratory/proof-of-principle studies
Facilitates theory/experiment dialogue
Educates future scientists

Challenges: Requires significant resources (people, time, ideas, money)

Example CMS Open Data Studies

Momentum Balance in Jets

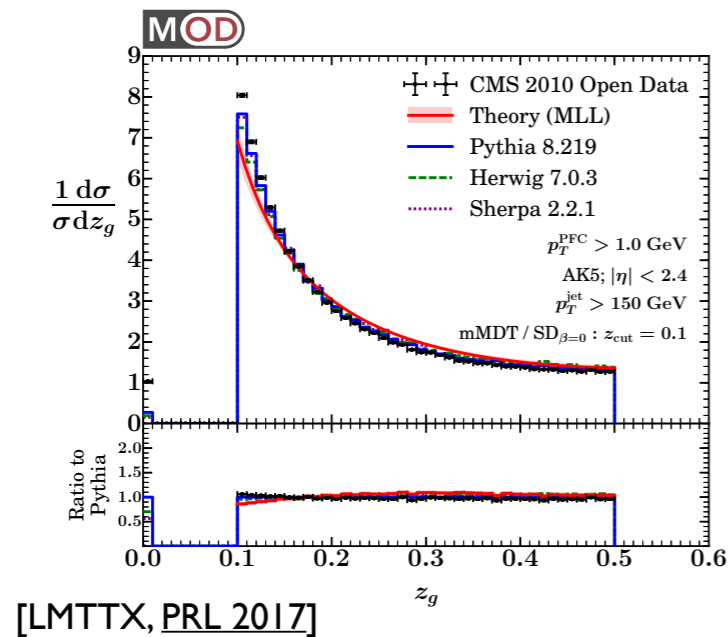

Search for Dimuon Resonances

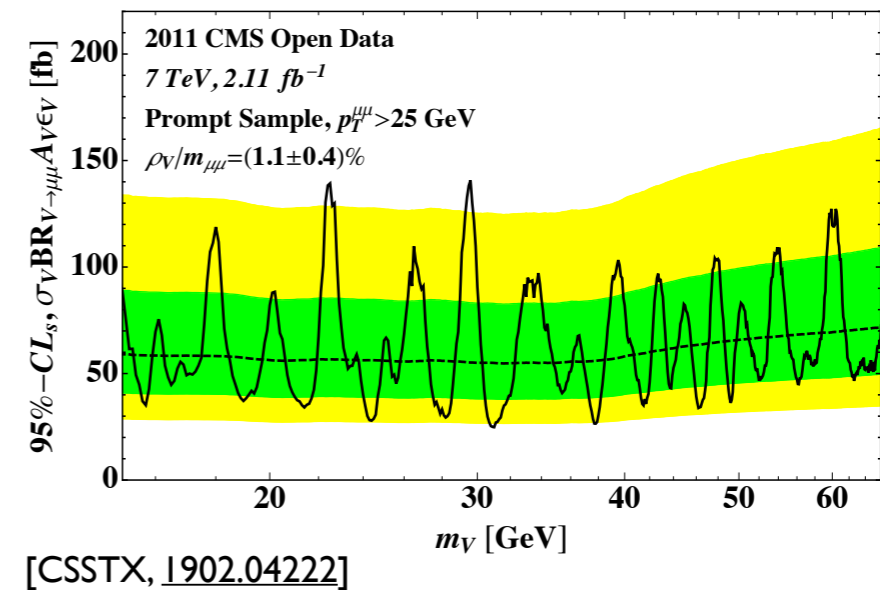

Parity Violation in Jets

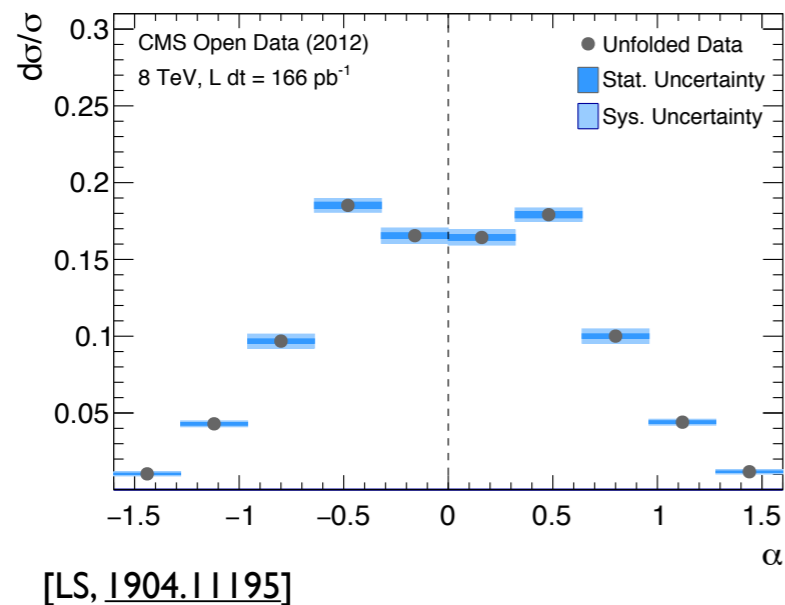

Machine Learning Studies

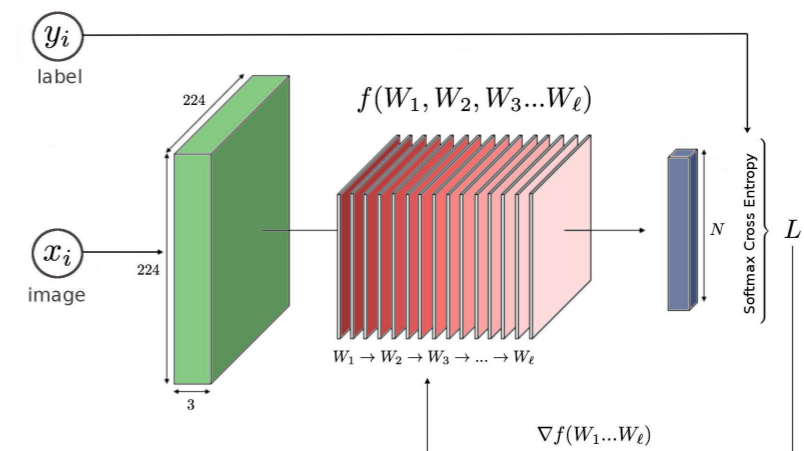

[MCIL, 1708.07034; see also APGP, 1807.11916]

High Energy Physics



HEP is a discovery-focused field



HEP is a curiosity-driven / technology-driven field

*We build world-class facilities with world-wide participation,
and we continually push their scope and capabilities*

*We are inspired and guided by key science drivers,
but we are always seeking new avenues for discovery*

Relevance of HEP to Society

Why has the pursuit of science for its own sake had such a remarkable track record in generating transformative new technology?

The reason must be that Nature poses deeper and more challenging questions than humans can do, and the struggle to understand Nature forces us to invent better and deeper ideas than we would if left to our devices.

[from Gross, *IJMPA* 2016]

Some Required Reading

MEDICINE

- ▶ **Radiation treatment plans for cancer** are powered by software originally developed to model particle detectors, and treatments with gamma rays and protons are delivered using particle accelerator technology.

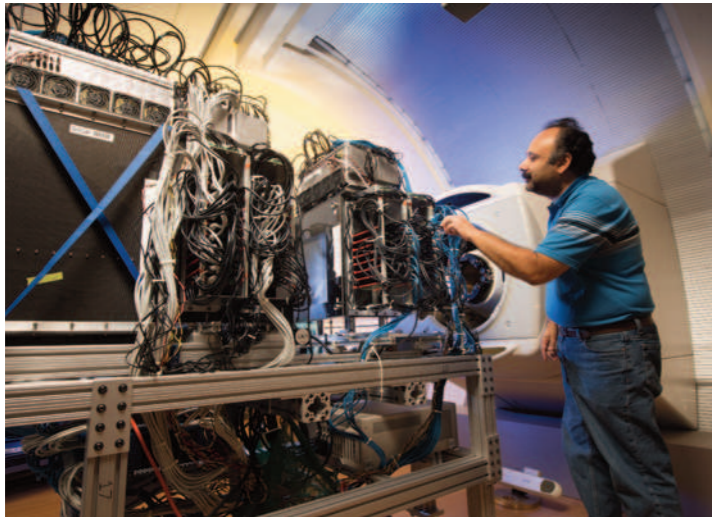

Proton therapy for cancer

SENSORS

- ▶ **Chemistry, biology, and materials science** researchers use sensors developed for particle physics in cameras that collect signals from visible and infrared light and from X-rays.

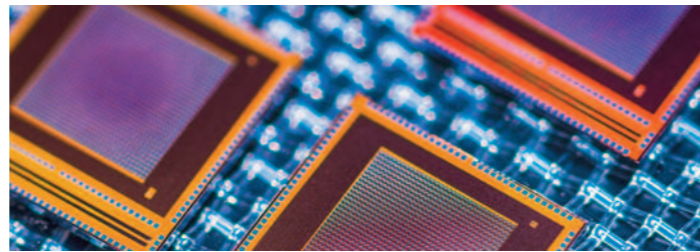

X-ray sensors

COMPUTING AND SIMULATION

- ▶ **The World Wide Web** was first developed by particle physicists to share information quickly and effectively around the world. Particle physicists continue to push the frontiers of big data analysis with global grids and cloud computing.

NATIONAL SECURITY

- ▶ U.S. scientists helped create a muon detector system to **safely look inside the nuclear reactors** in Fukushima after the earthquake and tsunami in Japan.



Muon scanning at Fukushima

Important to emphasize that transformative concepts and technologies in HEP are also relevant to society at large

[from Particle Physics Makes a Difference in Your Life (2019)]

The European Strategy Update



Useful Context and Perspectives:

Summary Talks at the Open Symposium (Granada, May 12–19, 2019)

APS Division of Particles and Fields White Papers:
Community Planning and Science Drivers
Tools for Particle Physics

Important Considerations:

Snowmass 2020+ will happen after European HEP strategic planning

CERN is a key international partner, from LHC to protoDUNE

International collaboration will be essential to build and operate next collider(s) beyond HL-LHC