

# Laboratory Plasma Astrophysics & Beyond

**Hantao Ji**

*Department of Astrophysical Sciences  
Princeton Plasma Physics Laboratory  
Princeton University*



FESAC Meeting  
April 10, 2014



# Acknowledgements

S. Balbus, S. Bale, E. Belova, A. Bhattacharjee, E. Blackman, J. Buechner, M. Burin, A. Branderburg, J. Breslau, M. Brown, J. Burch, T. Carter, F. Cattaneo, L.-J. Chen, W. Daughton, P. Diamond, S. Dorfman, J. Drake, E. Edlund, G. Fiksel, C. Forest, W. Fox, D. Froula, S. Gerhardt, C. Gisinger, J. Goodman, M. Hesse, S. Hsu, M. Inomoto, N. Jain, J. Jara-Almonte, A. Kageyama, K. Kemel, R. Kulsrud, A. Kuritsyn, E. Lawrence, H. Li, W. Liu, L. Malyshkin, F. Mozer, C. Myers, P. Nilson, M. Nornberg, Y. Ono, E. Oz, F. Perkins, T. Phan, S. Prager, C. Ren, Y. Ren, J. Rhoads, A. Roach, R. Rosner, V. Roytershteyn, J. Sarff, E. Schartman, E. Spence, J. Stone, P. Terry, S. Terry, T. Tharp, R. Torbert, F. Trinchouk, G. Tynan, A. Viavads, Y. Wang, T. Watanabe, J. Xie, M. Yamada, J. Yoo, S. Zaharia, E. Zweibel

Center for Magnetic Self-Organization (**CMSO**)

Center for Momentum Transport & Flow Organization (**CMTFO**)

Max-Planck/Princeton Center for Plasma Physics (**MPPC**)



# General Messages of This Talk

## (from the examples of lab plasma astrophysics)

- FES-supported plasma physics research is at the forefront of science (essential for an Office of Sciences program)
- FES science has spin-offs relevant to other parts of DOE (e.g, Nuclear Energy, Environmental Management)
- FES science links to areas of science supported by other agencies (e.g., space physics, astrophysics, astronomy by NSF and NASA)
- Leveraging and partnering, scientifically and financially, with other disciplines and funding sources is crucial. Benefits greatly outweigh risks.

# Plasma pervades the universe at all scales

Heliophysics  
( $<10^{-4}$  light year)

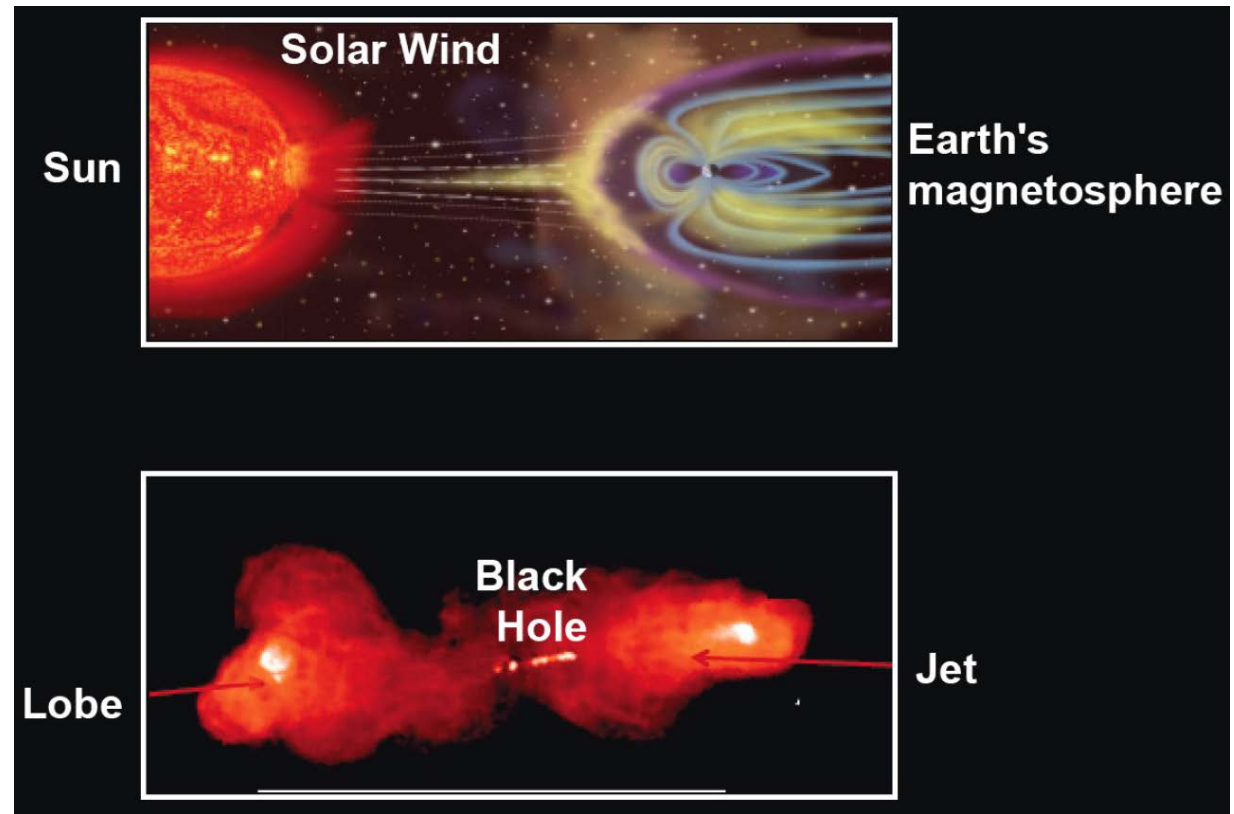

Astrophysics  
( $>10^6$  light year)

**Plasma astrophysics:** understand our visible universe via plasma physics  
It addresses **the third** important question in the universe:

Dark energy drives expansion of the universe

Dark matter controls largest structures of the universe

**Plasma processes are key in deciding all the rest**

# 10 Major Plasma Processes

2010 Workshop on Opportunities in Plasma Astrophysics (WOPA)

1. Magnetic Reconnection
2. Collisionless Shocks and Particle Acceleration
3. Waves and Turbulence
4. Magnetic Dynamo
5. Interface and Shear Instability
6. Angular Momentum Transport
7. Dusty Plasma
8. Radiative Hydrodynamics
9. Relativistic, Pair-Dominated, Strongly Magnetized Plasmas
10. Jets and Outflows

# 10 Major Plasma Processes

2010 Workshop on Opportunities in Plasma Astrophysics (WOPA)

1. Magnetic Reconnection
2. Collisionless Shocks and Particle Acceleration
3. Waves and Turbulence
4. Magnetic Dynamo
5. Interface and Shear Instability
6. Angular Momentum Transport
7. Dusty Plasma
8. Radiative Hydrodynamics
9. Relativistic, Pair-Dominated, Strongly Magnetized Plasmas
10. Jets and Outflows

# Roles of Laboratory Experiments in Understanding Astrophysical Plasmas

- Motivated by space and astrophysical observations
- Verify/confront existing theory; discover new physics → **essential for connection to astrophysics**
- Benchmark/challenge simulation → **unique opportunity to validate astrophysics codes**
- Compare with observations → **support space missions**
- Understand fundamental plasma processes → **applications to fields beyond astrophysics, such as fusion**

# Magnetic Reconnection

**What:** Rapid release of magnetic energy through topological rearrangements of field lines

**Why important:** Key to explain phenomena ranging from magnetospheric storms, solar flares, energetic activity on magnetars, to dissipation in any magnetized systems, such as fusion plasmas

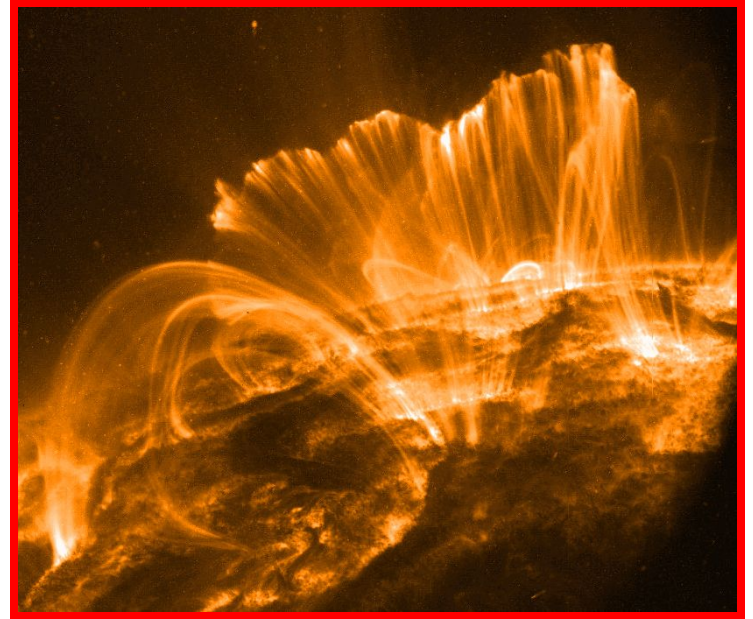

**Major questions:**

- Why reconnection is fast, compared with theoretical prediction?
- How does reconnection take place in 3D?
- How is magnetic energy converted to plasma energy?
- How does reconnection scale with plasma size and conductivity?



# Proved Classical Sweet-Parker Theory 50 Years Later in a Real Plasma *in the Collisional Limit*

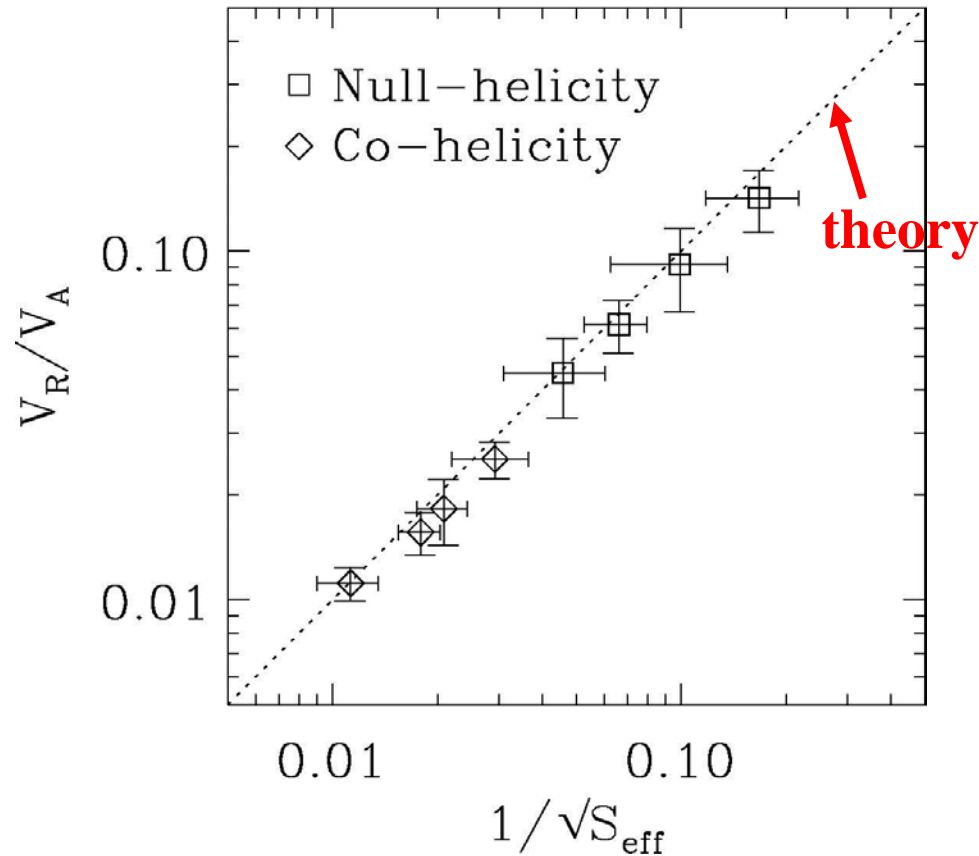

MRX (PPPL)

The favored Petschek reconnection still not seen (yet)!

# Confirmed Two-Fluid Effects for Fast Reconnection *In the Collisionless Limit*

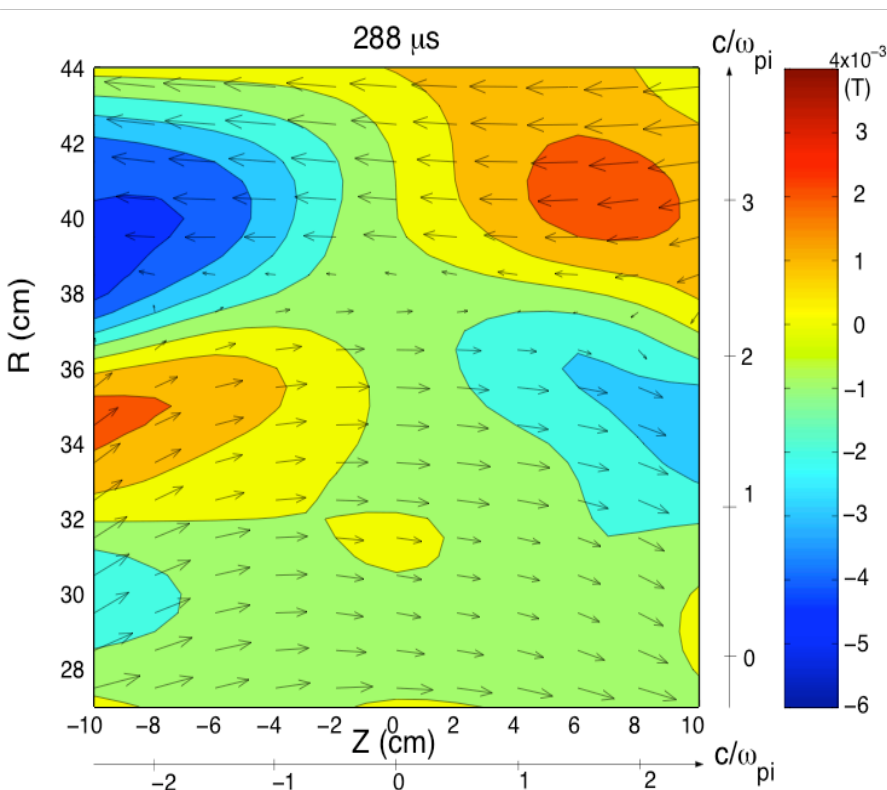

POLAR satellite

Predicted quadrupolar structure of out-of-the-plane field component compares well with space observations

*MRX (PPPL),  
SSX (Swarthmore)*

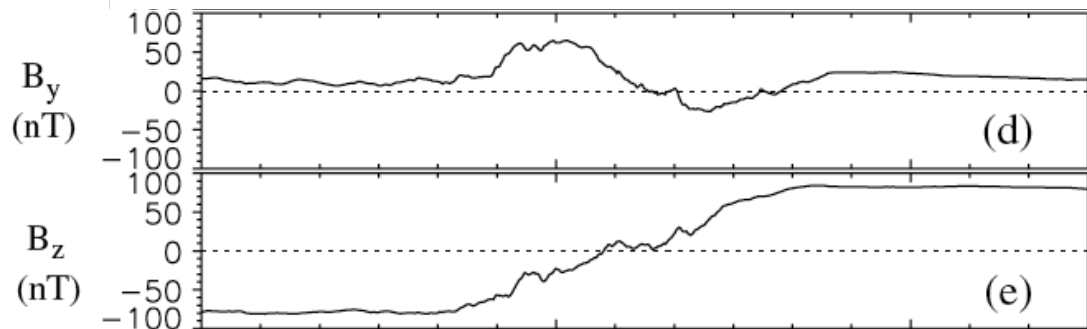

# Challenged Numerical Simulations on Electron Layer Thickness

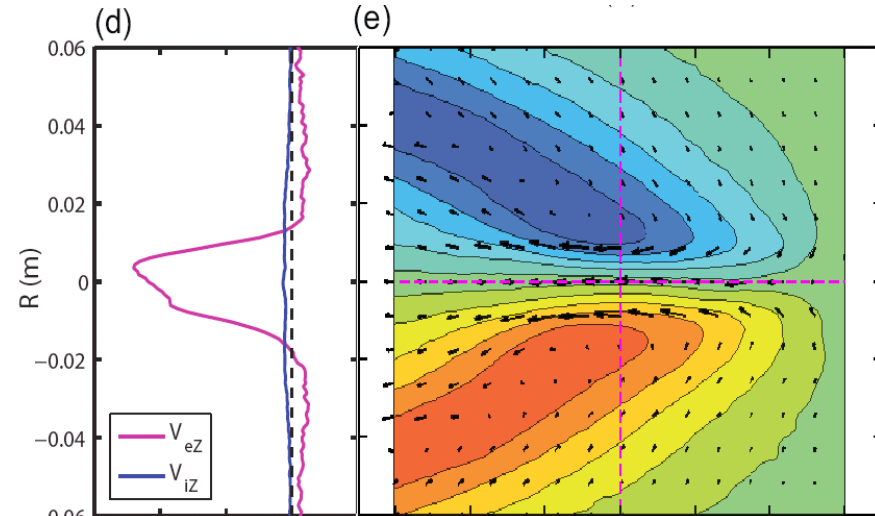
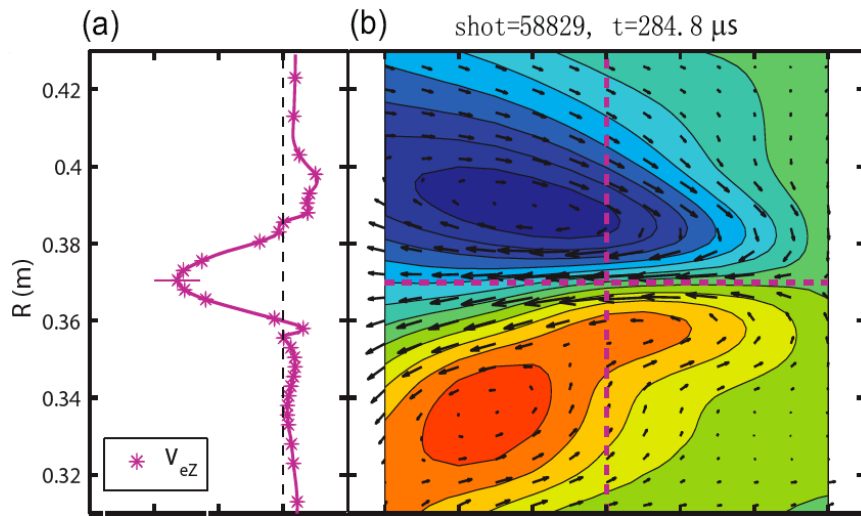

MRX:

$$\delta_e = 8 c/\omega_{pe}$$

2D PIC Sim:

$$\delta_e = 1.6 c/\omega_{pe}$$

➔ 3D physics, such as waves and/or flux ropes

# Current Frontier: Ion Heating by Reconnection

*TS-3*  
(Tokyo)

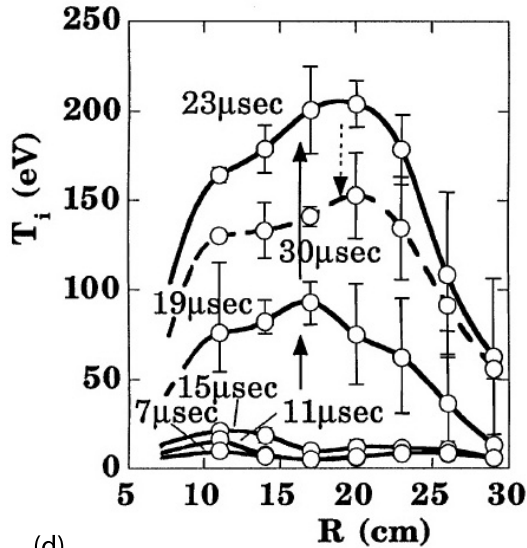

*VTF*  
(MIT)

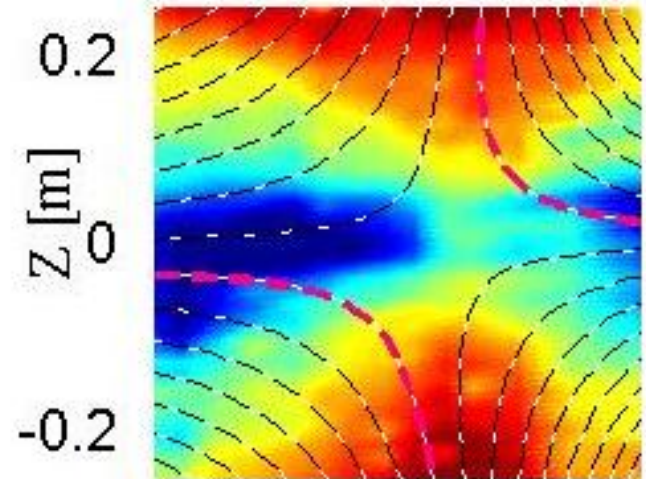

*MST*  
(Wisconsin)

*MRX*  
(PPPL)

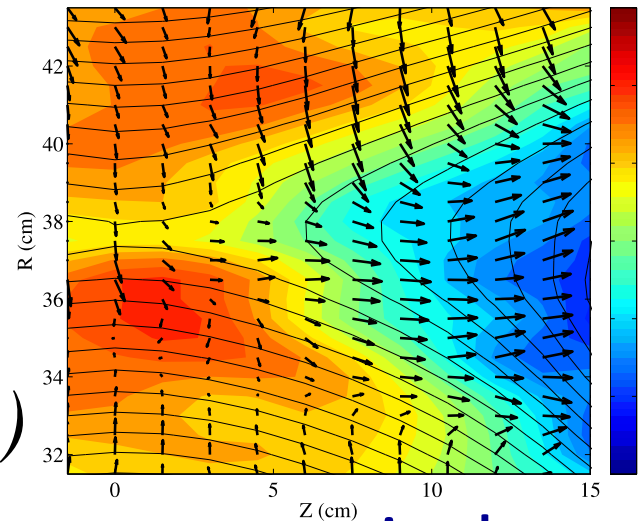

Close comparisons with theory, numerical simulations and space observations underway

# New Frontier: Experimental Access to More Astrophysically Relevant Regimes

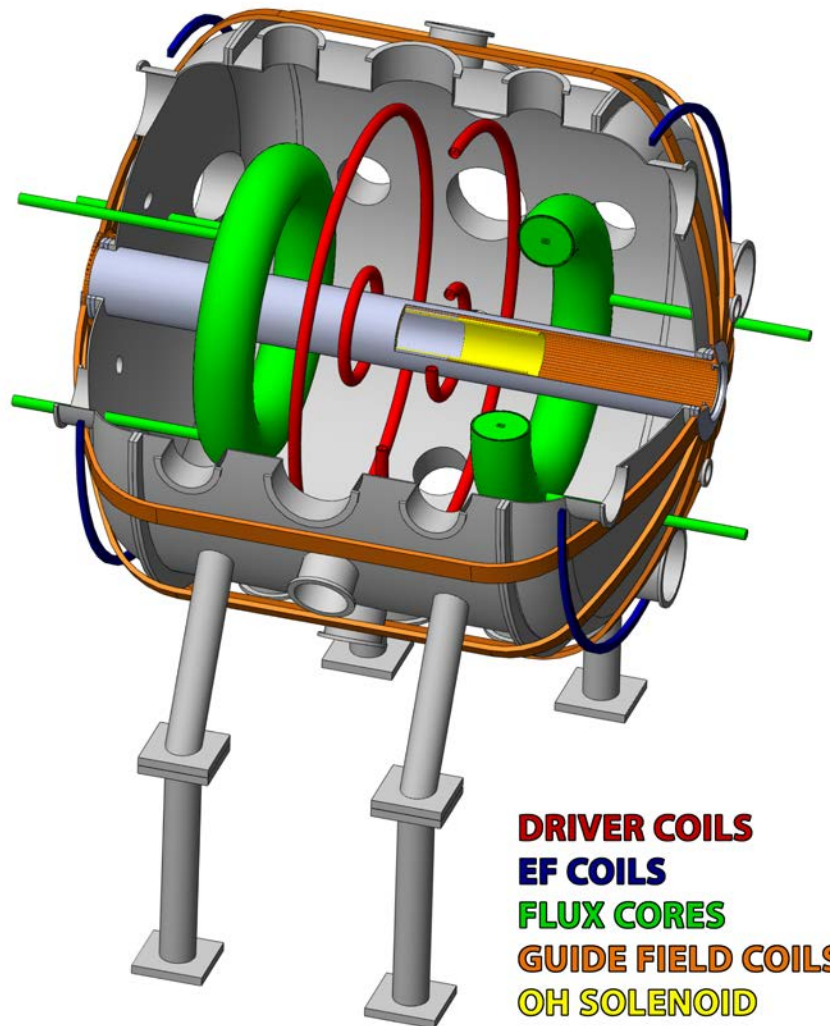

## FLARE (Facility for Laboratory Reconnection Experiment):

- Much larger parameter space than MRX for astro-relevant regimes
- Proposed by a consortium of 5 universities and 2 national labs
- Construction funded by NSF Major Research Instrument Program
- Will function as the core of a collaborative user facility
- 40 collaborative users from 5 communities (basic plasma, space, solar, astrophysics and fusion)
- To be ready for research by 2016

# Entering a New Era for Laboratory Reconnection Research

- A cluster of laboratory experiments: TS-3/4(Tokyo), Caltech, SSX (Swarthmore), RSX(LANL), LAPD/ETPD(UCLA), VINETA (Max-Planck), TREX(Wisconsin), MRX/FLARE(Princeton), SPRF/HRX (China)..., fusion devices
- A cluster of space satellites: CLUSTER, POLAR, THEMIS, MMS (2014); SDO, STEREO, HINODE, IRIS, SPP (2018)...
- A cluster of numerical models: MHD, multi-fluid, hybrid, full kinetic, gyro-kinetic...
- Collaborative multiple communities
- Collaborative multiple funding agencies: DOE, NSF, NASA...

# Angular Momentum Transport

**What:** Redistribution of angular momentum through instabilities and turbulence.

**Why important:** Key for star and planet formation, accretion onto black holes powering the most luminous objects in the universe



**Major questions:**

- Does the well-known Magnetorotational Instability (MRI) exist?
- If so, how does it saturate transporting angular momentum?
- Does pure hydro instability exist when disk is too cold for MRI?
- How do effects beyond MHD modify MRI and its turbulence?

# The Basic Experimental Idea

- Create relevant flows in a disk or cylindrical geometry
- Axial boundaries modified to minimize end effects
- Use liquid metal or plasma for MRI, with appropriate external  $B_z$
- Use water or gas for nonlinear hydro instabilities

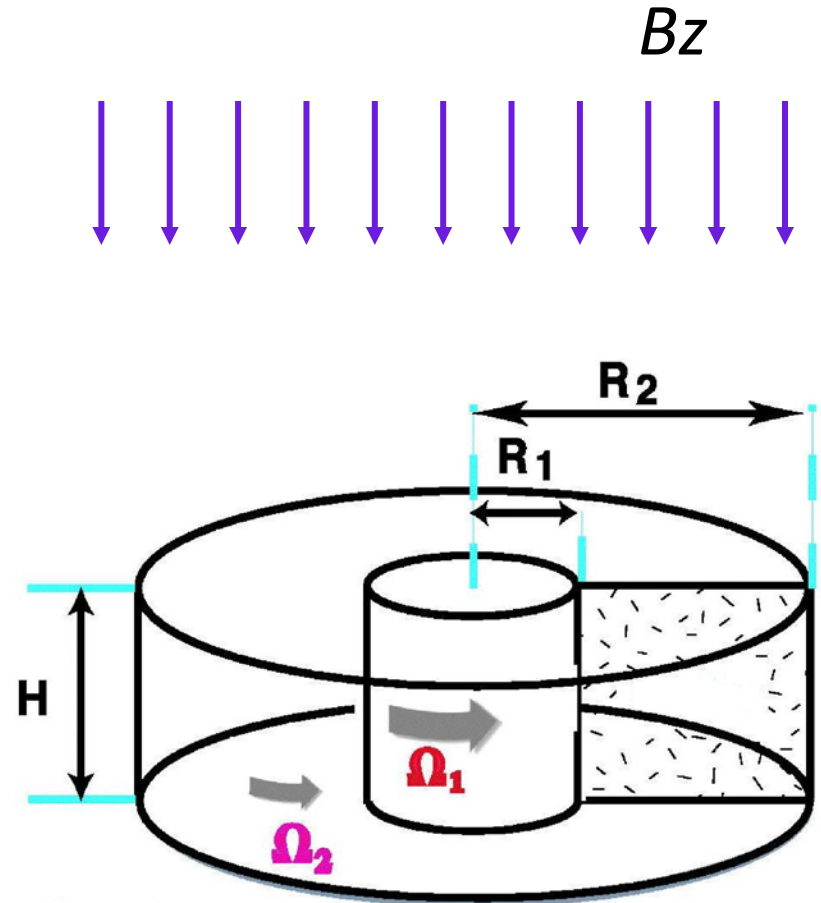



# Disproved Pure Hydro Candidates: No Signs of Turbulence Even at $Re > 10^6$

$$\beta \equiv \frac{\langle \tilde{V}_r \tilde{V}_\theta \rangle}{q^2 \langle V_\theta \rangle^2}$$

Normalized  
Turbulent  
Torque

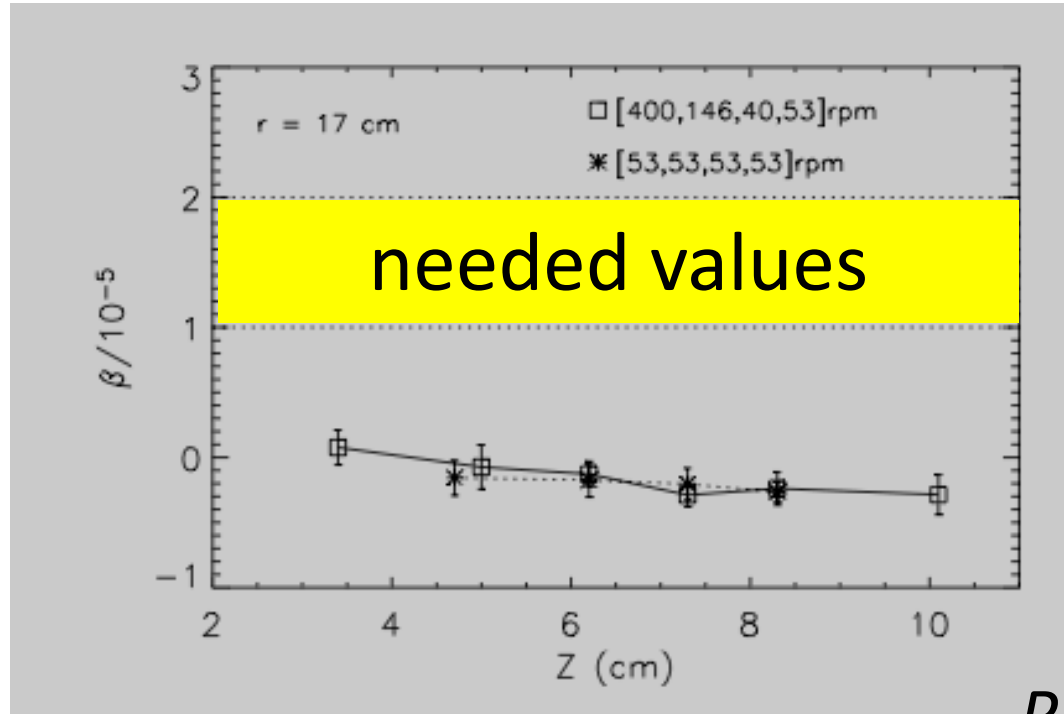

axial distance

*Princeton MRI  
Experiment  
HTX (PPPL)*

**Effectively ended debates in astrophysics community,  
while excited new debates in fluid dynamics community**

# Discovered a New Instability of Free-shear Layer Formed by Axial Boundary and Magnetic Field

Experiment

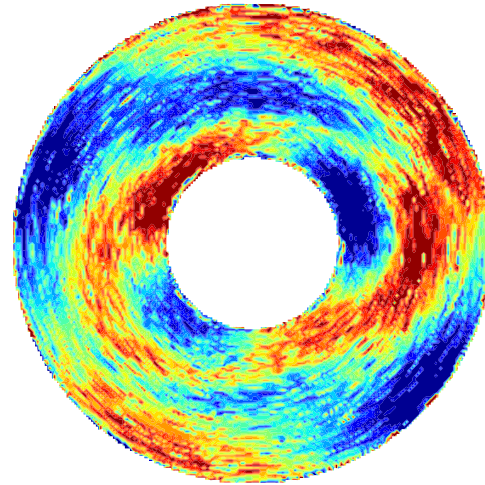
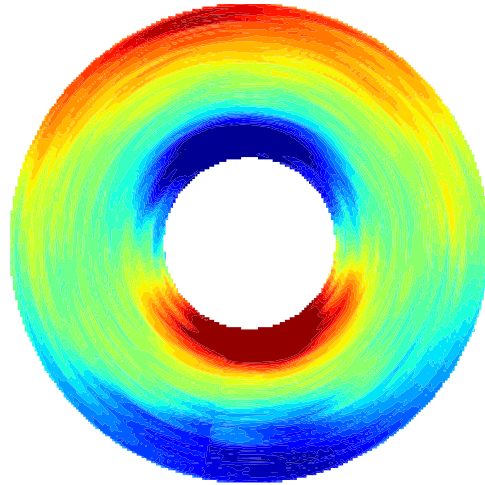

Experiment

Theory

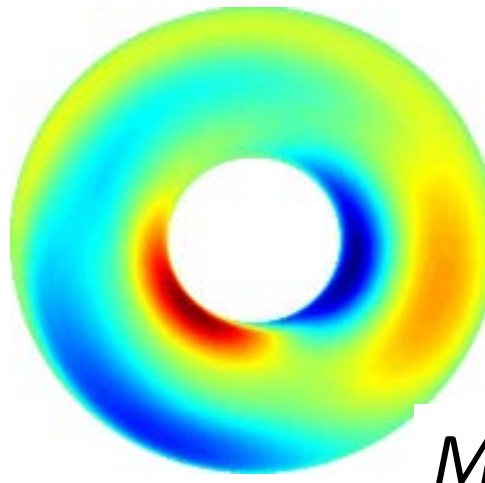
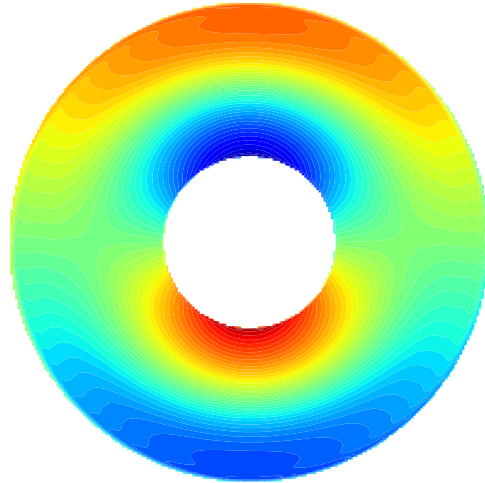

Simulation

**Possible geophysical applications**

*Maryland,  
Princeton MRI*

**Current and New Frontiers:  
Conclusively Detect MRI; Study Its Turbulence;  
Explore Non-MHD Effects**

*PCX  
(Wisconsin)*

**MRI remains theoretical until proven experimentally**

# Spinoff: Applications for Centrifuges

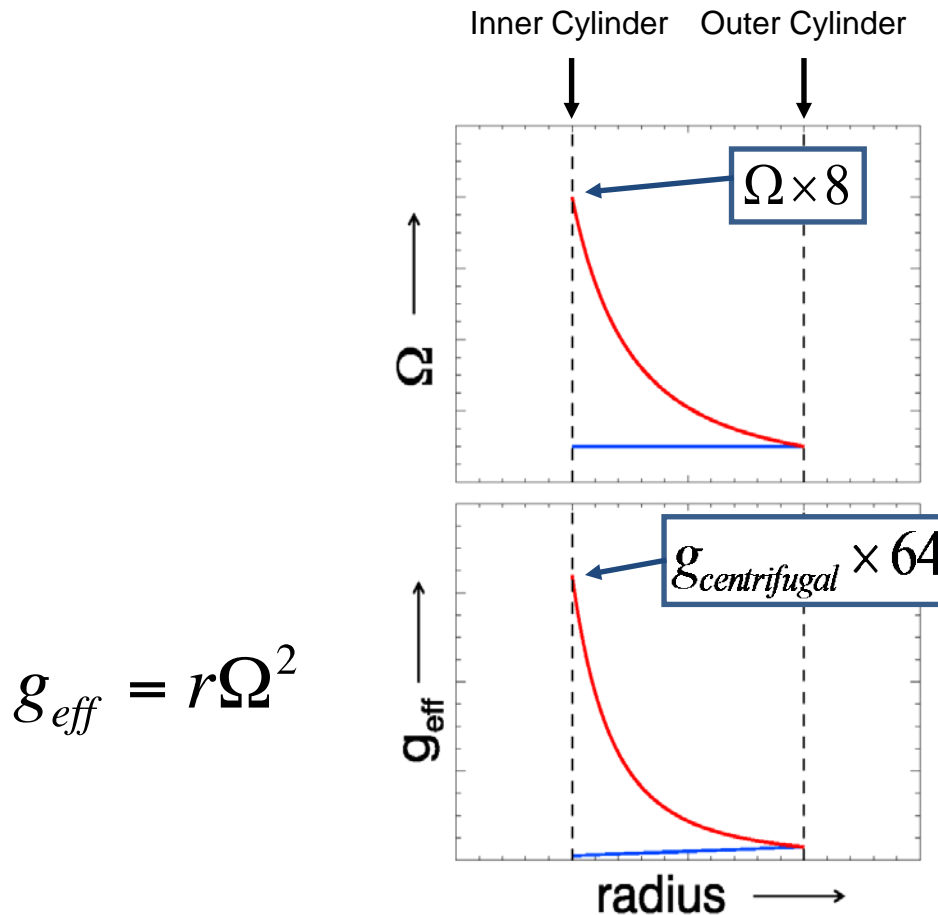

$$g_{eff} = r\Omega^2$$

HTX (PPPL)

Improve liquid centrifuges to separate nuclear wastes (for Offices of Nuclear Energy and Environmental Management) and to recycle Aluminum (for Industry)

# Interface and Shear Instability

**What:** Instabilities arising from spatial nonuniformity in composition and flow.

**Why important:** They cause turbulent transport and mixing, crucial for phenomena like X-ray bursts from neutron star, nova, supernova.

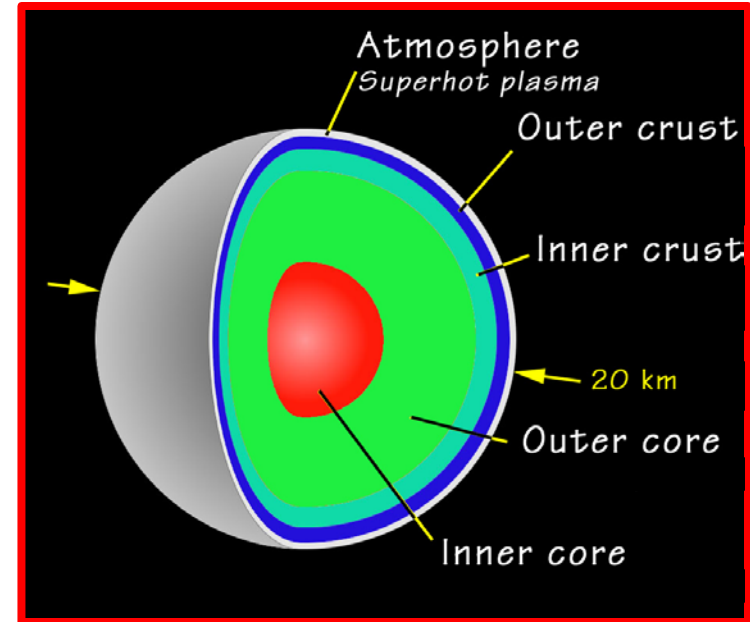

MHD flow in “plasma ocean” on neutron star surface under strong gravity

**Major questions:**

- How do magnetic fields affect shear instability and the resultant turbulence, especially in a free-surface flow?
- How do magnetic fields affect properties of heat transfer and material mixing?

# The Basic Experimental Idea

- Create a free-surface liquid metal channel flow
- Impose an external magnetic field either vertically or horizontally
- Probe flow stability by inserting a heated cylinder upstream
- Study heat transfer by depositing heat on the flow surface

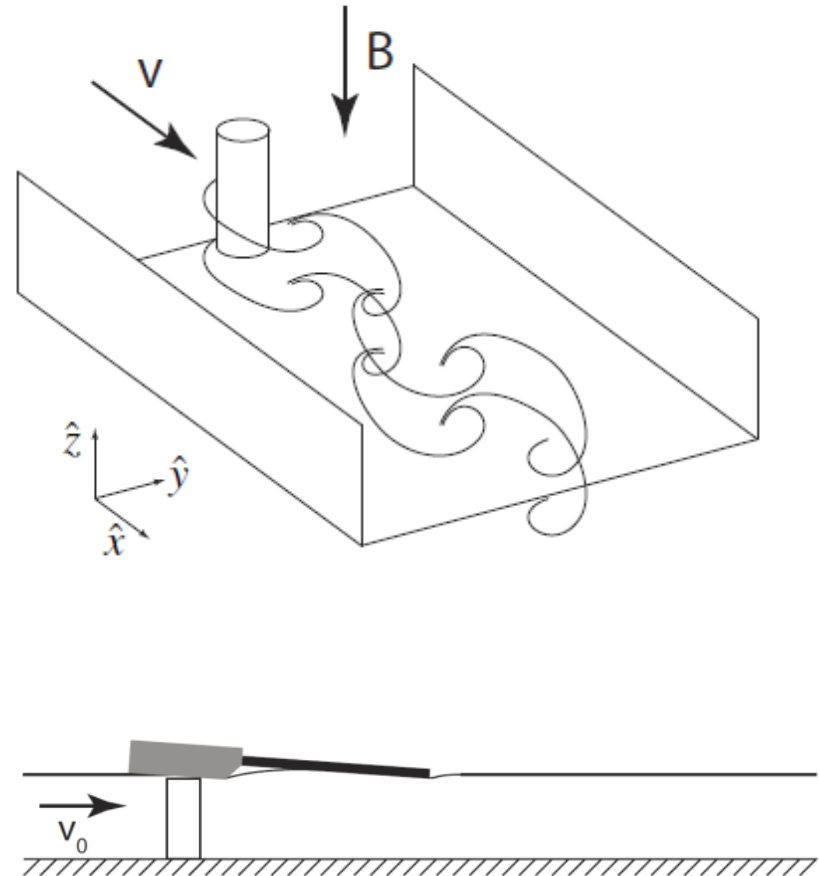



# Heat Transfer *Enhanced* by Strong B

temperature  
increase at  
bottom of  
downstream

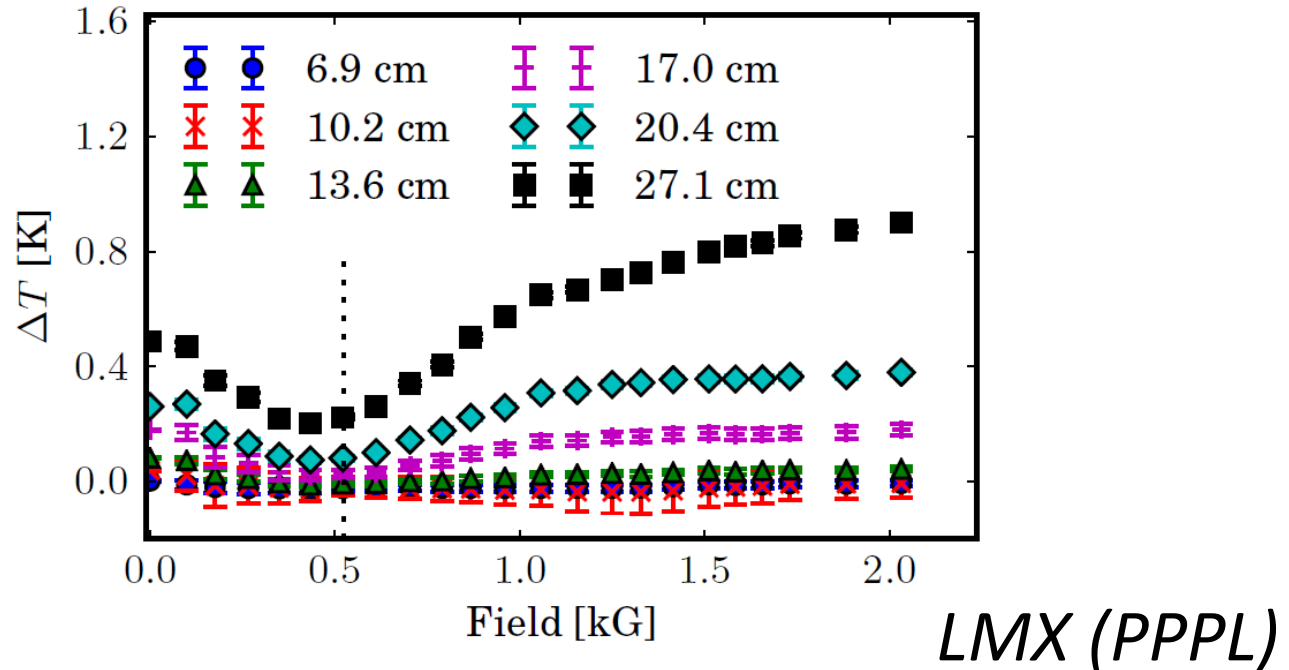

**2D vortex dynamics important in heat transfer: implications for fusion applications of free-surface liquid metal flow.**



# General Messages of This Talk

## (from the examples of lab plasma astrophysics)

- FES-supported plasma physics research is at the forefront of science (essential for an Office of Sciences program)
  - Help address the third important question (reconnection, accretion...)
- FES science has spin-offs relevant to other parts of DOE (e.g, Nuclear Energy, Environmental Management)
  - Improve efficiencies of liquid centrifuges
- FES science links to areas of science supported by other agencies (e.g., space physics, astrophysics, astronomy by NSF and NASA)
  - Laboratory study of astro ideas, which in turn help fusion science
- Leveraging and partnering, scientifically and financially, with other disciplines and funding sources is crucial. Benefits greatly outweigh risks.
  - NSF funds mid-scale experiments (UCLA, Wisconsin, Auburn, Princeton)
  - NASA funds space mission-related research (e.g. MRX for MMS)