



U.S. DEPARTMENT OF
ENERGY

Office of
Science

Advanced Scientific Computing Research

Presented to the

Advanced Scientific Computing Advisory Committee

by

Barbara Helland
Associate Director

April 17, 2018

FY 2019 SC Budget Request

(Dollars in Thousands)

	FY 2017		FY 2018		FY 2019				
	Enacted Approp.	Current Approp.	Annualized CR ^b	Enacted Approp.	President's Request	President's Request vs. FY 2018 Enacted		President's Request vs. FY 2017 Enacted	
ASCR.....	647,000	626,559	642,606	810,000	899,010	89,010	11.0%	252,010	39.0%
BES.....	1,871,500	1,812,113	1,858,791	2,090,000	1,850,000	-240,000	-11.5%	-21,500	-1.1%
BER.....	612,000	588,826	607,844	673,000	500,000	-173,000	-25.7%	-112,000	-18.3%
FES.....	380,000	368,119	377,419	532,111	340,000	-192,111	-36.1%	-40,000	-10.5%
HEP.....	825,000	802,849	819,397	908,000	770,000	-138,000	-15.2%	-55,000	-6.7%
NP.....	622,000	604,473	617,776	684,000	600,000	-84,000	-12.3%	-22,000	-3.5%
WDTS.....	19,500	19,500	19,368	19,500	19,000	-500	-2.6%	-500	-2.6%
SLI.....	130,000	130,000	129,117	257,292	126,852	-130,440	-50.7%	-3,148	-2.4%
S&S.....	103,000	103,000	102,301	103,000	106,110	3,110	3.0%	3,110	3.0%
PD.....	182,000	182,000	180,764	183,000	180,000	-3,000	-1.6%	-2,000	-1.1%
SBIR/STTR (SC).....	154,561
Subtotal, Science.....	5,392,000	5,392,000	5,355,383	6,259,903	5,390,972	-868,931	-13.9%	-1,028	0.0%
SBIR/STTR (DOE).....	90,813
Rescission of PY Bal ^a	-1,028	-1,028	-1,021	1,028	-100.0%
Total, Science.....	5,390,972	5,481,785	5,354,362	6,259,903	5,390,972	-868,931	-13.9%

^a Rescission of PY funds in the amount -\$239K for FY12 and older; -\$239K for FY13; and -\$550K for FY14 - FY16.

^b FY 2018 Annualized CR column is based on the FY 2017 Enacted minus a 0.6791% reduction totaling \$36.617M



ASCR FY 2019 President's Request

(\$K)

	FY 2017	FY 2018		FY 2019		
	Enacted Approp.	President's Request	Enacted Approp.	Request	FY2019 Request vs. FY 2018 Enacted Approp.	
Mathematical, Computational, and Computer Sciences Research	107,121	100,668	113,522	141,099	27,577	+24.3%
SBIR/STTR	10,271	11,261	4,301	5,532	1,051	+24.4%
Total, Mathematical, Computational, and Computer Sciences Research	117,392	111,929	117,823	146,631	28,808	+24.5%
High Performance Computing and Network Facilities	352,446	398,773	469,760	500,887	31,127	+6.6%
SBIR/STTR	13,162	14,728	17,417	18,786	1,369	+7.9%
Total, High Performance Computing and Network Facilities	365,608	413,501	487,177	519,673	32,496	+6.7%
Exascale Computing						
17-SC-20 Office of Science Exascale Computing Project (SC-ECP)	164,000	196,580	205,000	232,706	27,706	+13.5%
Total, Advanced Scientific Computing Research	647,000	722,010	810,000	899,010	89,010	+11.0%
<i>Computational Sciences Workforce Programs, with WDTS (non-add)</i>	<i>(10,000)</i>	<i>(10,000)</i>	<i>(10,000)</i>	<i>(10,000)</i>
<i>Exascale Computing Crosscut (non-add)</i>	<i>(164,000)</i>	<i>(346,580)</i>	<i>(377,500)</i>	<i>(472,706)</i>	<i>(+95,206)</i>	<i>(+25.2%)</i>

The following is the only direction provided for ASCR.

Within available funds, the agreement provides \$205,000,000 for the Exascale Computing Project, \$110,000,000 for the Argonne Leadership Computing Facility, \$162,500,000 for the Oak Ridge Leadership Computing Facility, \$94,000,000 for the National Energy Research Scientific Computing Center at Lawrence Berkeley National Laboratory, \$10,000,000 for the Computational Sciences Graduate Fellowship program, and \$79,000,000 for ESnet.



ECI FUNDING

By Appropriation and Program (\$K)

	FY 2017 Enacted	FY 2019 Request	FY 2019 Request vs FY 2017 Enacted
Office of Science (SC)			
Advanced Scientific Computing Research (ACSR)			
SC-Exascale Computing Project (SC-ECP, 17-SC-20)	\$164,000	\$232,706	+\$68,706
<i>ECP Focus Area 1: Applications</i>	\$97,000	\$120,706	+\$23,706
<i>ECP Focus Area 2: Software</i>	\$37,000	\$62,000	+\$25,000
<i>ECP Focus Area 3: Hardware</i>	\$30,000	\$50,000	+\$20,000
Argonne Leadership Computing Facility (ALCF)	\$0	\$140,000	+\$140,000
Oak Ridge Leadership Computing Facility (OLCF)	\$0	\$100,000	+\$100,000
Total, SC Exascale¹	\$164,000	\$472,706	+\$308,706
National Nuclear Security Agency (NNSA)			
Advanced Simulation and Computing (ASC)			
Advanced Technology Development & Mitigation (ATDM)	\$95,299	\$95,073	-\$226
<i>ECP Focus Area 1: Applications</i>	\$23,000	\$30,000	+\$7,000
<i>ECP Focus Area 2: Software</i>	\$37,299	\$35,073	-\$2,226
<i>ECP Focus Area 3: Hardware</i>	\$25,000	\$0	-\$25,000
<i>ECI Stockpile Applications</i>	\$10,000	\$11,000	+\$1,000
<i>ECI Advanced Architecture System & Software</i>	\$0	\$19,000	+\$19,000
Exascale Class Facility Modernization (18-D-680)	\$0	\$23,000	+\$23,000
Exascale Class Computer Cooling Equipment (18-D-670)	\$0	\$24,000	+\$24,000
Exascale System	\$0	\$21,000	+\$21,000
Total, NNSA Exascale²	\$95,299	\$163,073	+\$67,774
Total, ECI	\$259,299	\$635,779	+\$376,480

¹ The SC-ECP project was initiated in FY 2017 to prepare the LCFs for deployment of at least one exascale system included in ECI. Only a portion of the OLCF funds are shown because they are also operating Summit which is a 200 PF pre-exascale system; funding for the ALCF is primarily focused on the delivery of the exascale system. BES investments in computational materials and chemistry applications are also included in ECI but not shown on the table for FY 2017 and beyond.

² The FY 2019 request includes \$47M to construct cooling equipment and support infrastructure to prepare for deployment of pre-exascale and exascale systems at LANL and LLNL, respectively.



Components of the DOE Exascale Program

- **Exascale Computing Initiative (ECI)**

- The ECI was initiated in FY 2016 to support research, development and computer system procurements to deliver an exascale (10^{18} ops/sec) computing capability by the early to mid-2020s.
- It is a partnership between SC and NNSA, addressing science and national security missions.
- *In the FY2018 President's Budget request, ECI includes the SC/ASCR and NNSA/ASC facility investments in site preparations and non-recurring engineering activities needed for delivery of early to mid-2020s exascale systems.*

- **Exascale Computing Project (ECP)**

- Beginning in FY 2017, the ASCR ECI funding was transitioned to the DOE project (ECP), which is managed according to the principles of DOE Order 413.3B.
- The ECP subprogram in ASCR (SC-ECP) includes only support for research and development activities in applications, and in partnership with NNSA, investments in software and hardware technology and co-design required for the design of capable exascale computers .
- The NNSA/ASC Advanced Technology Development and Mitigation (ATDM) program supports the development of applications and, in collaboration with SC/ASCR, investments in software and hardware technology and co-design required for the design of exascale capable computers.



ECP Independent Project Review

- **Held January 9-11, 2018 in Oak Ridge**
- **In preparation for IPR**
 - **Independent Design Review of Preliminary Design Report held December 5, 2017** and found *“that the ECP has restructured and realigned their technical approach to reflect the changes to the project’s scope, schedule and budget in order to meet the overall project goals and KPPs.”*
 - **Red Team Review held December 6, 2017** and found *“the ECP management team to be highly skilled, experienced, and committed to the success of the Project. The technical approach is appropriate; supports the mission need; and is responsive to the recent baseline change.”*
- **Charge Questions:**
 1. Has the project satisfactorily addressed recommendations from the September 13-15, 2016 Project Review?
 2. Does the documentation, including the Preliminary Design Report and Preliminary Project Execution Plan (PPEP), describe the current ECP scope and plans with rigor appropriate for this stage of the project (pre CD-2)? Does the project document reflect an actionable tailoring strategy?
 3. Is the risk-informed milestone-based plan, with its associated resources and contingencies, reasonable for ECP to meet its mission need and preliminary KPP?
 4. Is the proposed baseline change reasonable and have the risks associated with the changes appropriately considered and documented.
 5. Is the management team appropriately structured with the requisite skills, experience and resources and empowered to ensure success of the project?
 6. Has the project negotiated an actionable engagement plan with the appropriate DOE SC and NNSA Computing facilities to ensure mutual success?
 7. Is the project on track to meet its major milestones as identified in the PPEP?



Recommendations from IPR

- Revise the gap analysis document regularly, at least annually.
- Revise initial ST Level 4 milestones by third quarter FY 2018 to remove vagueness and improve relevance.
- ECP and facilities need to work on an ongoing basis to achieve earliest possible access to test-beds, timelines, and information on chip/system architecture features.
- Add a HI and facilities breakout session to future independent project reviews including members of all the facilities in use by ECP.
- Expedite NDAs for the projects so AD and ST understand the hardware challenges and implications they will be facing early on.
- Refine and finalize the KPPs (including Figures of Merit and impact metrics) as soon as possible prior to CD-2.

The Senior Leadership Team is well-structured with clear areas of responsibilities staffed by extremely capable people, and led by world-class, high-performance computing leaders. Further, the creation of an integration team, connected to and through facilities, is a good path forward, and is critical for success. However, ECP management does not control the interface. The Laboratory Operations Task Force is probably in the best position to help with this conflict.



ASCR Facilities Engagement with ECP

- **Initial version of the ECP-Facility Engagement Framework scrutinized by the ECP Independent Project Review (IPR) committee in early Jan 2018**
 - recommended using a single engagement framework to develop specific facility plans (by Sep 2018)
- **ECP and facilities subsequently held a 2-day meeting (Feb 22-23, 2018) to lay out a process for developing actionable plans (joint milestones) for FY18-19**
 - Identified mutually-beneficial activities & outcomes to be refined into key milestones and deliverables
 - Immediate follow-up actions
 - ECP brief of its application portfolio to facilities
 - ECP hardware evaluation effort now analyzing CORAL-2 benchmarks
 - ECP software deployment effort working with facilities to implement automated continuous integration and testing resources and technologies for assessment of ECP's Software Development Kits
- **Formal joint milestones currently being refined and reviewed for next revision of the ECP-Facility Engagement Plan (delivered by Apr 30 2018)**
 - Each facility's milestones will appear as an appendix in the engagement framework, with one or more milestones articulated in ECP's Hardware and Integration WBS Level 3 areas
 - Software Deployment
 - Hardware Evaluation
 - Application Integration
 - Training
- **What is included in the Engagement plan**
 - Facilities help prepare a subset of ECP applications for future pre-exascale and exascale upgrades; ECP will provide some support for Post Docs and staff time
 - Facilities will work with ECP to provide a test beds and allocations for the software stack and applications use
 - Facilities and ECP will hold joint training programs and hackathons



CORAL 2

- **ORNL released the CORAL-2 RFP April 9, 2018**
 - Continues partnership between Argonne National Laboratory, Lawrence Livermore National Laboratory and Oak Ridge National Laboratory
 - Calls for non-recurring engineering activities and up to three exascale high performance computing systems

Laboratory	Description
ORNL	System delivered in 2021 and accepted in 2022 (ORNL system)
LLNL	System delivered in 2022 and accepted in 2023 (LLNL system)
ANL	Potential System delivered in 2022 and accepted in 2023 (ANL system)

- **Anticipated budget range for each system plus any associated NRE is \$400M-\$600M**
- **Proposals Due: May 24, 2018 by 5:00 pm Eastern Time**

- Hardware installation completed in March
- Continuing to stabilize nodes, disks, and network
- In Dec., accepted 1,080 of 4,608 nodes to port codes
- OLCF is working with IBM, NVIDIA, Red Hat, and Mellanox to stabilize and debug system software



- **FLASH – AMR code widely used by astrophysics community**
 - Summit “fundamentally changes the potential science impact” by enabling large-network simulations of 160+ nuclear species that *could not run on Titan*.
- **QMCPACK – accurate quantum mechanics-based simulation of materials, including High- T_c superconductors**
 - Current release version getting ~50x performance over Titan; 3.7x increase in complexity or scale of the materials computable in the same time to solution.
 - Weak-scaled QMCPACK to 1,024 nodes
- **XGC – PIC code capable to model the tokamak fusion plasma edge**
 - Summit enables new science in XGC by allowing the electron time step to be realistically small for ITER edge plasma, which *is not possible with Titan*
 - 32 Summit nodes is 3x faster than 192 nodes of Titan; weak-scaled XGC to 1,024 nodes.
- **HACC – high-resolution, hybrid cosmology code**
 - Explore new regimes of baryonic physics in cosmological simulations on Summit.
 - Short-range solver 6.7x faster than Titan; Weak-scaled to 1,024 nodes and strong-scaled to 512 nodes.

Innovative and Novel Computational Impact on Theory and Experiment (INCITE) Program for 2019

- Access to the most capable, most productive, fastest open science supercomputers in the nation
- Call for proposals submission window:
 - Apr 16 – Jun 22, 2018
- Applicable to a broad array of science, engineering, and computer science domains
- Proposals must be:
 - High-impact, computationally and/or data intensive campaigns
 - Must take advantage of unique HPC architectures
 - Research that cannot be performed anywhere else.
- For more information visit <http://www.doeleadershipcomputing.org/>



Facility Project Reviews

- **Conducted**

- November 7-9, 2017, ALCF-3 Re-baseline review; panel recommended approval
- November 28-29, 2017, OLCF-5 CD-1 review; panel recommended approval
- January 18, 2018 ESAAB approved ALCF-3 Re-baseline and OLCF-5 CD-1

- **Anticipated in 2018**

- June 26-28, 2018 CD 1/3A ESnet-6
- August, CD-2/3 IPR for NERSC-9
- November/December CD-4 for Summit
- TBD, CD-2/3 IPR for OLCF-5 (CORAL 2)



RESEARCH



U.S. DEPARTMENT OF
ENERGY

Office of
Science

FY 2020 Planning: Laboratory Reverse Site Visits

Purpose: To inform ASCR's planning process to maintain and improve a robust research program in the near future and to provide each Laboratory an opportunity to communicate its plans to leverage and maintain its unique expertise and core capabilities in order to advance research in support of ASCR's mission.

Structure: Each Laboratory will present its plans during a 2.5 hour visit to Germantown.

Emphasis:

- The template for the presentations highlights the following: Mission Relevance, Self-Analysis of Strengths and Weaknesses, Realistic Budget Scenarios.
- Labs can also propose their ideas for ASCR Integrated Research Activities (IRA). In addition to supporting individual PIs at a lab and universities, as envisioned, IRAs will be lab-based and support a collection of research projects and activities in a major activity in Applied Mathematics or Computer Science, including Networking Research, which requires sustained funding and supports ASCR's and the Laboratory's mission.

2018 Schedule

Laboratory	Date
SNL	May 1st
BNL	May 2nd
ORNL	May 3rd
ANL	May 4th
LANL	May 11th
LLNL	May 14th
PNNL	May 15th
LBNL	May 18th

Early Career Research Program FOA Update

- **Eligibility**

- No more than ten (10) years can have passed between the year the Principal Investigator's Ph.D. was awarded and the year that the FOA was issued. For the present competition, those who received doctorates no earlier than 2007 are eligible.
- University: The Principal Investigator must be an untenured Assistant Professor on the tenure track or an untenured Associate Professor on the tenure track at a U.S. academic institution as of the deadline for the application.
- Lab: The Principal Investigator must be a full-time, permanent, non-postdoctoral national laboratory employee as of the deadline for the proposal.

- **Key Dates**

- December 18, 2017: University and Laboratory Funding Opportunity Announcements released
- Thursday, January 25, 2018: Pre-applications due at 5:00 PM EST
- Tuesday, February 27, 2018: Encourage/Discourage notification process completed
- **Wednesday, April 4, 2018: Final Proposals due at 5:00 PM EST --**
 - **ASCR received 105 proposals (67 University; 38 Laboratory)**
- Thursday, May 31: Internal SC Selection Process complete

Funding Opportunity: DE-FOA-0001900, LAB 18-1900

2018 Mathematical Multifaceted Integrated Capability Centers (MMICCs)

This purpose of this Announcement is to invite proposals for basic research that address DOE mission challenges from a perspective that requires new integrated efforts across multiple mathematical, statistical, and computational disciplines.

Funding Opportunity: \$5,000,000/year for 4 years

Program Manager: Steven Lee

Posted: April 4, 2018

Pre-Proposals: Due by April 30, 2018

Pre-Proposals Encouraged/Discouraged: By May 4, 2018

Full proposals: Due by May 23, 2018

Review Panel: Mid-June 2018

Expected number of MMICC project awards: 2 - 3

Individual awards within a project: \$300K/year - \$2,500,000/year

QATs & QCATs

Quantum Algorithm Teams & Quantum Computing Application Teams

Purpose: Build on ASCR's fundamental science community to advance basic research in quantum algorithms and in quantum computer science.

Emphasis: Interdisciplinary teams of QIS experts, applied mathematicians and computer scientists that adopt a methodical approach to fill in the missing elements in order to connect SC grand challenges to quantum computing hardware.

NEW QCAT LAB PROGRAM ANNOUNCEMENT:

Algorithms, Software Stack, V&V

Pre-proposals due: May 16th, 2018

Proposals due: June 29th, 2018

https://science.energy.gov/~media/grants/pdf/lab-announcements/2018/LAB_18-1898.pdf

3 QAT PROJECTS @ TOTAL \$4M/YEAR:

Quantum Algorithms, Mathematics and
Compilation Tools for Chemical Sciences.

Lead: LBNL (Bert de Jong), Collaborators: ANL, Harvard University. <https://qat4chem.lbl.gov/overview>

Heterogeneous Digital-Analog Quantum

Dynamics Simulations. Lead: ORNL (Pavel Lougovski),
Collaborator: University of Washington.

<https://hdaqds.ornl.gov/index.html>

Quantum Algorithms from the Interplay of
Simulation, Optimization, and Machine

Learning. Lead: SNL (Ojas Parekh), Collaborators: LANL,
CalTech, UMD, VCU. <https://qoalas.sandia.gov/>



FY 2018: Quantum Testbeds Pathfinder

Purpose: To provide decision support for future investments in quantum computing (QC) hardware and increase both breadth and depth of expertise in QC hardware in the DOE community. Expands last year's program.

Emphasis: Research in the relationship between device architecture and application performance, including development of meaningful metrics for evaluating device performance.

Timeline & Proposals:

- A DOE National Laboratory Announcement and companion FOA were published on March 19, 2018.
- Preproposals/preapplications due on April 16, 2018.
- Full proposals due on May 14, 2018.

Anticipated Funding: \$2M/year

FY 2018: Quantum Testbeds for Science

Purpose: To provide the research community with novel, early-stage quantum computing resources and advance our understanding of how to use these resources for advancing scientific discovery.

Motivation: Researchers will need low-level access to quantum computing devices, and even the ability to modify these devices, to experiment with different implementations of gates and circuits, explore programming models, and understand the practical consequences of device imperfections. (2017 Quantum Testbed Stakeholder Workshop Report)

Details: Quantum Testbed for Science (QTS) Laboratories will function as small collaborative research facilities that host experimental quantum computing resources on site, provide external researchers with access to and support in using these resources, and sponsor community engagement activities. Research performed at the QTS Laboratories will inform the design of next-generation devices, ensuring that tomorrow's quantum computers will be capable of running quantum algorithms in support of DOE's science and energy mission.

Timeline & Proposals:

- A DOE National Laboratory Announcement was published on April 6, 2018.
- Preproposals due on May 14, 2018.
- Full proposals due on June 8, 2018.

Anticipated Funding: \$9M/year

The First Simulation of an Atomic Nucleus on Quantum Cloud

Significance: First application of quantum computers in nuclear physics and it opens the avenue for quantum computations of heavier nuclei via quantum cloud access

Highlight: Computed the binding energy of the deuteron (nucleus of 2_1H – bound state of a proton and a neutron)

Research Details:

- Implemented Variational Quantum Eigensolver (VQE) with a novel low-depth Unitary Couple Cluster (UCC) wavefunction ansatz
- Performed systematic error mitigation using hybrid quantum-classical data post processing
- Computed Deuteron's binding energy -2.28 MeV (True value -2.22 MeV; 3% error)

E. F. Dumitrescu *et al.*, accepted in Phys. Rev. Lett. (April 2018) (PRL Editors' Suggestion) [arXiv:1801.03897]

***Collaborative effort between ORNL's QAT (P.Lougovski), Quantum Testbed (R.Pooser) and NUCLEI SciDAC-4 (T.Papenbrock) teams**

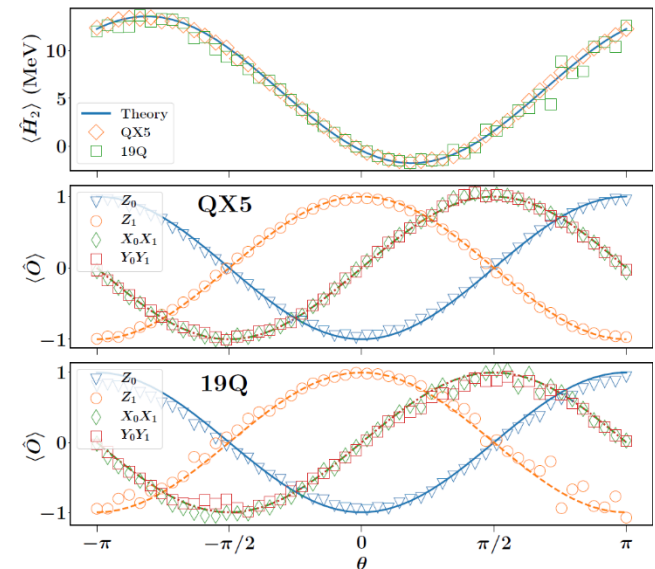

Experimentally determined binding energies for the deuteron (top) and expectation values of the Pauli terms that enter the two-qubit deuteron Hamiltonian as determined on the IBM QX5 (center) and Rigetti 19Q (bottom) chips as a function of the variational parameter. Experimental (theoretical) results are denoted by symbols (lines).

Scientific Achievement

Simulated quantum circuits inspired by tensor networks were trained to classify images of handwritten numerals.

Significance and Impact

Quantum computing promises a fundamentally different set of capabilities than are available classically, and it is an open question how best to apply these emerging tools to the domain of machine learning. Circuits based on tensor networks present serious advantages for the small and noisy devices which will be available in near future.

Research Details

- Entire circuit, including model input, is easy to prepare and execute on near-term devices. Optimization is performed in a hybrid quantum/classical loop.
- For image classification, a number of qubits that is logarithmic in the dimension of the number of pixels is sufficient, and numerical simulations indicated a high level of resilience to noise.

Work was a collaboration between UC Berkeley (QAT PI: Birgitta Whaley) and The Flatiron Institute.

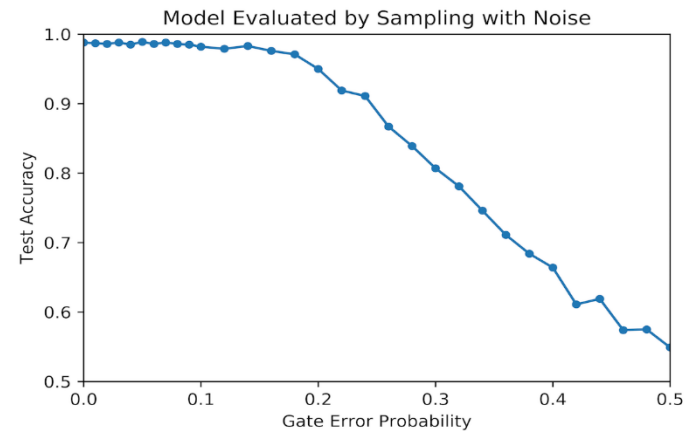
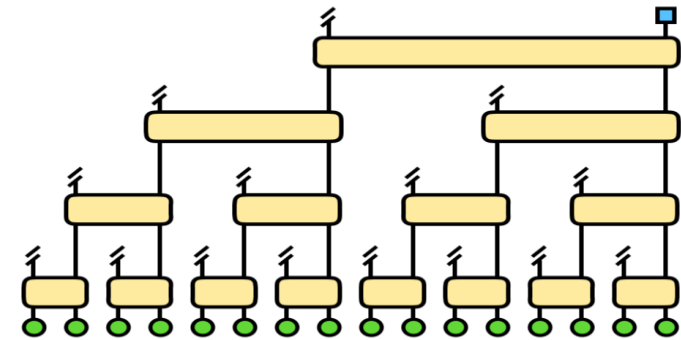

Above: A diagram of the circuit, where the input qubits are represented by green circles, unitary gates by yellow rectangles, unobserved outputs by hash marks, and the labeling output by a blue square.

Below: The accuracy of the model on a held out test set evaluated by a majority vote of 400 samples at various noise levels.

Solicitations with ASCR SciDAC Participation

- 1. Scientific Discovery through Advanced Computing (SciDAC): Runaway Electron Avoidance and Mitigation in Tokamak Plasmas.**
 - FOA/LAB 18- 1844 joint solicitation led by Fusion Energy Sciences (FES)
 - Pre-proposals due 6 April 2018
 - Proposals due 14 May 2018

- 2. Nuclear Data Interagency Working Group / Research Program**
 - LAB (only) 18-1903 solicitation issued by Nuclear Physics (NP) includes terms for potential collaboration with SciDAC-4 Institutes
 - LOI due 13 April 2018
 - Proposals due 15 June 2018

Enabling Global Adjoint Tomography at scale through next-generation I/O

Scientific Achievement

Most detailed 3-D model of Earth's interior showing the entire globe from the surface to the core-mantle boundary, a depth of 1,800 miles.

Significance and Impact

First global seismic model where no approximations were used to simulate how seismic waves travel through the Earth. The data sizes required for processing are challenging even for leadership computer facilities.

Research Details

- To improve data movement and flexibility, the Adaptable Seismic Data Format (ASDF) was developed that leverages the Adaptable I/O System (ADIOS) parallel library.
- It allows for recording, reproducing, and analyzing data on large-scale supercomputers
- **1PB of data is produced in a single workflow step**, which is fully processed later in another step.
- <https://www.olcf.ornl.gov/2017/03/28/a-seismic-mapping-milestone>

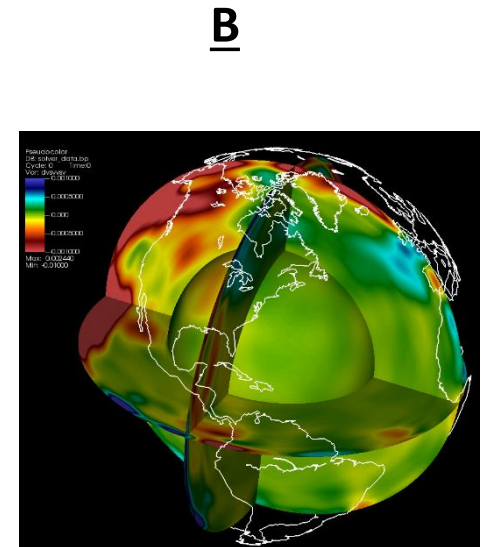
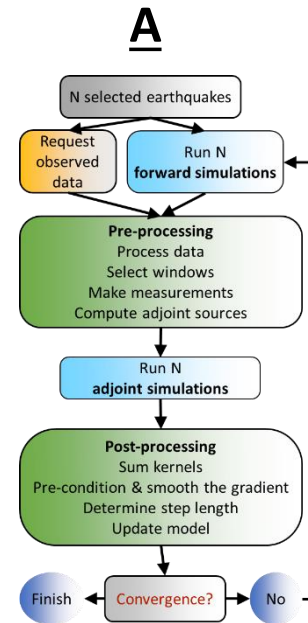

(A) Seismic Tomography workflow graph. The heavy computational steps are the Forward and Adjoint Simulations steps. They produce and consume the large data sets, respectively. **(B)** A visualization of the Earth's interior with unprecedented details from the seismic tomography process model, which maps the speeds of waves generated after earthquakes. (Image Credit Dave Pugmire)

Ebru Bozdag; Daniel Peter; Matthieu Lefebvre; Dimitri Komatitsch; Jeroen Tromp; Judith Hill; Norbert Podhorszki; David Pugmire.

Global adjoint tomography: first-generation model.

Geophysical Journal International 2016 207 (3): 1739-1766

<https://doi.org/10.1093/gji/ggw356>

New Unstructured Mesh Technologies are Being Developed for Fusion Applications

Scientific Achievement

Advanced unstructured mesh technologies support several fusion simulation codes including core and edge plasma, wall interactions, and RF interactions

Significance and Impact

Unstructured mesh tools decrease model preparation time and increase results accuracy. Unstructured mesh based particle-in-cell well suited to effective execution on new systems.

Research Details

- Developing new mesh generation accounting for the geometry, physics and needs of the numerical methods used
- High-order conforming and nonconforming mesh adaptation that effectively captures the physics of interest via in-memory integration into codes
- Developing unstructured mesh based particle-in-cell methods that will perform well on current and near term architectures

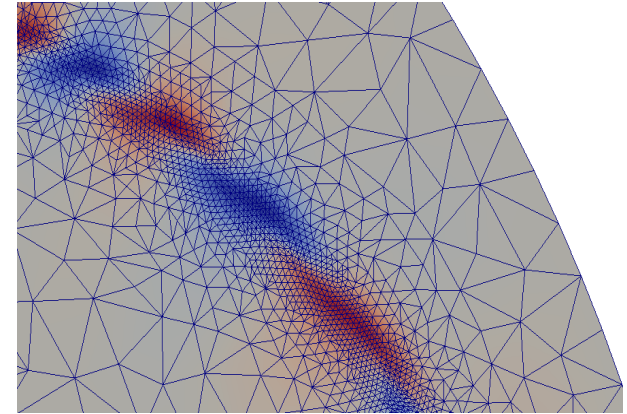

Adapted mesh from ELM study

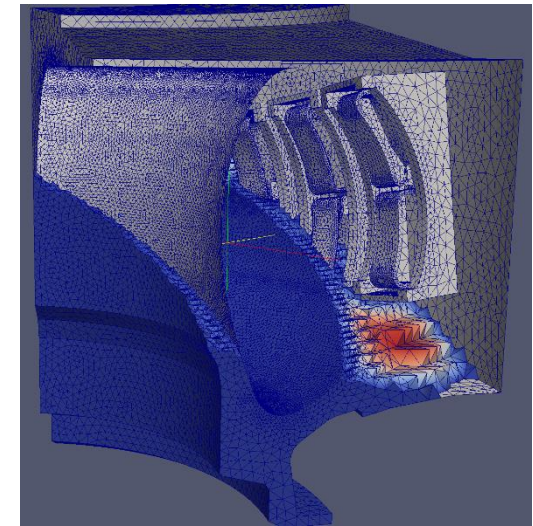

3D mesh for RF simulation



Extreme Heterogeneity Workshop

Held Virtually, Jan. 23-25, 2018, in Gaithersburg, MD

- POC: Lucy Nowell (Lucy.Nowell@science.doe.gov)
- **Goal: Define challenges that extreme heterogeneity presents to the software stack and programming environment and identify related Computer Science priority research directions** that are essential to making extremely heterogeneous systems useful, usable and secure for science applications and DOE mission requirements in the 2025-2035 timeframe.
- 148 expected participants: DOE Labs, academia, & industry
- ~20 observers from DOE and other federal agencies (DoD, NSF, NASA)
- Pre-workshop report is being edited and will be posted by Jan. 1, 2018
- 105 white papers were received by the Dec. 4 deadline
 - After review, these resulted in 26 new invitations to Lab people and 20 to non-Lab people, including academics, industry and people from Europe and Japan.
- Agenda is being finalized, based in part on white paper content

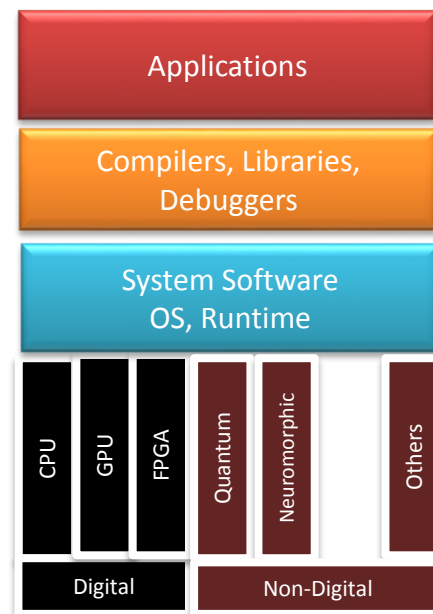

Scientific Machine Learning Workshop

Jan 30 to Feb 1, 2018

- **POC:** Steven Lee (steven.lee@science.doe.gov)
- **Co-organizers:** Mark Ainsworth (Brown) and Nathan Baker (PNNL)
- **Website:** <https://www.ornl.gov/ScientificML2018/>
- **Purpose:** Define priority research directions for applied mathematics in scientific machine learning (ML). Identify the challenges and opportunities for increasing the rigor, robustness, and reliability of ML for DOE missions.
- **Read-ahead material:** A brief survey of topics in ML with relevance to DOE missions; an overview of relevant DOE ASCR capabilities.
- **Challenges and themes:** ML mathematical foundations, reliability & rigor, complexity, interpretability, probabilistic ML, applications, tools & techniques.
- **Participants:** ~100 participants, including plenary speakers, panel members, and observers
- **Position papers:** Intended to broaden community participation; due Jan 5.
- **Final report due in Mar-Apr 2018.**

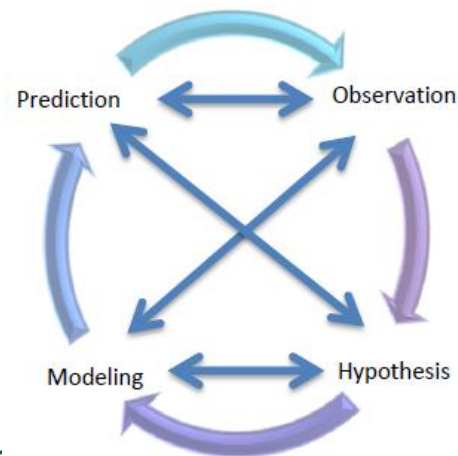

CSGF



Applicants by Permanent Address

450 applicants/448 valid US zip codes/2 other

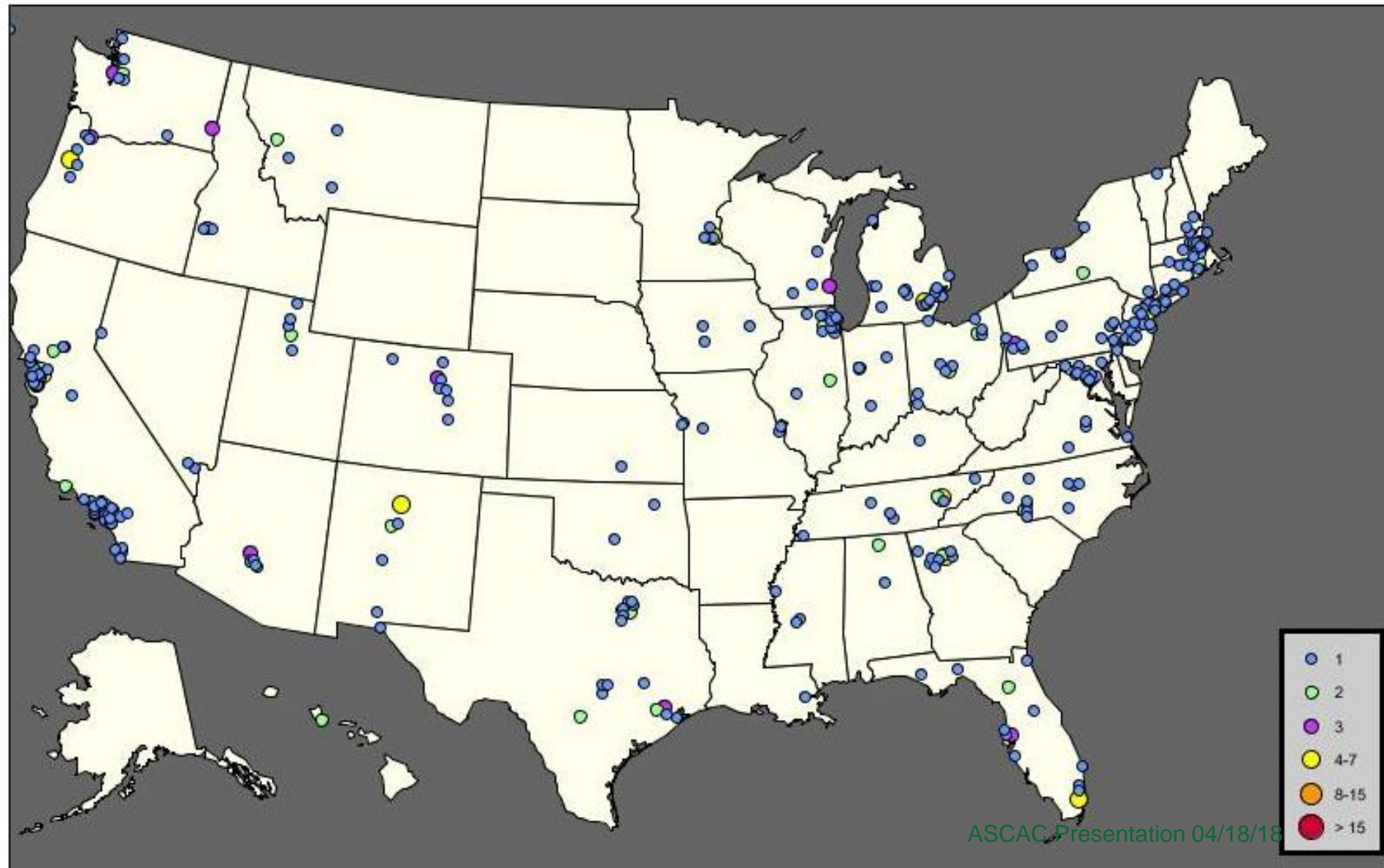

Applicants by Gender

Applicants are asked to fill out a survey with demographic questions.
Gender and race responses are not required.

All Applicants by Gender, 2016-2018 (%)

■ Male ■ Female ■ Did Not Report

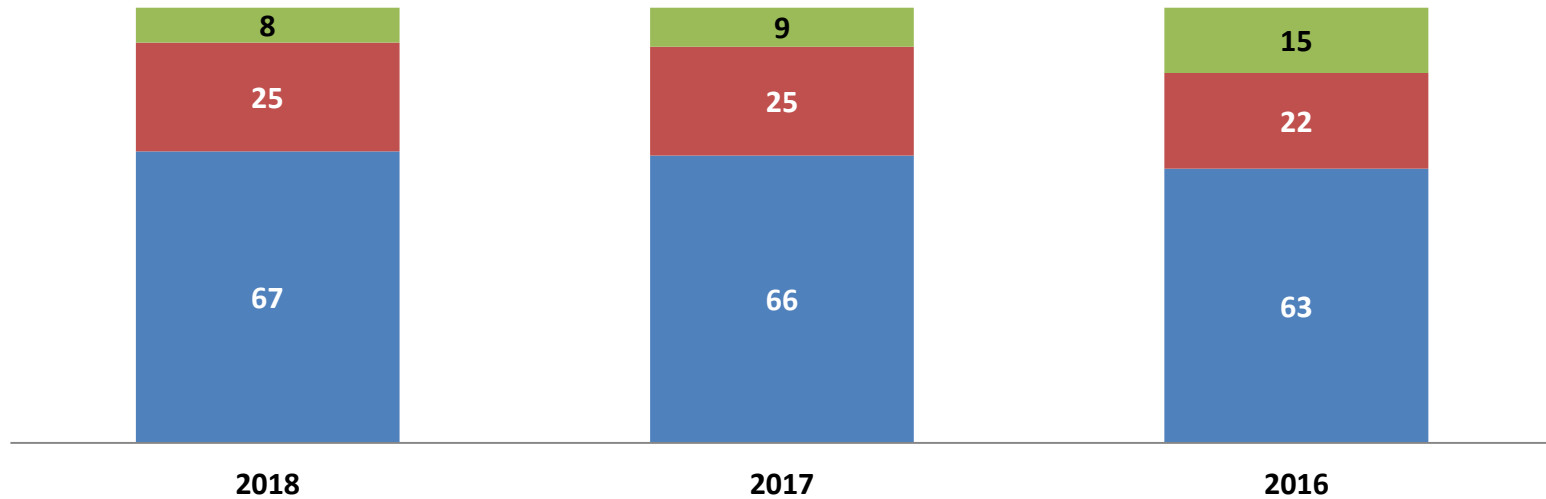

% of total at each stage

<i>Academic Status</i>	<i>All Trad.</i>	<i>After Screening</i>	<i>After Round 1 Selection</i>	<i>After Round 2 Selection</i>	<i>Finalists (top 20)</i>	<i>Finalists (+7)</i>
Undergraduate	27	31	37	47	50	57
Master's Degree	5	4	2	2	---	14
First-Year Doctoral	56	56	52	44	50	29
Employed	9	9	9	7	---	---
Second-Year Doctoral+ (ineligible)	2	---	---	---	---	---
Did not provide	<1	---	---	---	---	---

TRADITIONAL DOE CSGF

<i>Academic Status</i>	<i>All Math/CS</i>	<i>After Screening</i>	<i>Finalists (top 6)</i>	<i>Finalists (+3)</i>
Undergraduate	25	20	17	33
Master's Degree	12	5	---	---
First-Year Doctoral	42	65	66	67
Employed	17	10	17	---
Second-Year Doctoral+ (ineligible)	4	---	---	---

MATH/CS

First year of Math/CS Component

Fellowship	2018 (485 total)	2017 (507 total)
NSF	183	195
DOD	171	176
Hertz	27	24
DOE NNSA SSGF	22	16
University Sponsored	21	26
Ford	11	11
NPSC	10	15
NASA	8	11
GEM	6	9
DOE NEUP	1	7
Other	25	17

Applicants indicated they applied for other fellowships and could list multiple.

36 students represent 21 universities

- Brown
- Caltech
- Carnegie Mellon
- Cornell
- Harvard
- Kansas State
- Michigan State (2)
- MIT (6)
- Oregon State
- Stanford (6)
- Stony Brook
- U Chicago
- U Hawaii
- U Illinois U-C (4)
- U Notre Dame
- U Wisconsin
- UC Berkeley (2)
- UC Irvine
- UC Santa Barbara
- UT Austin
- Yale

Schools Attended by Current Fellows (by program year)

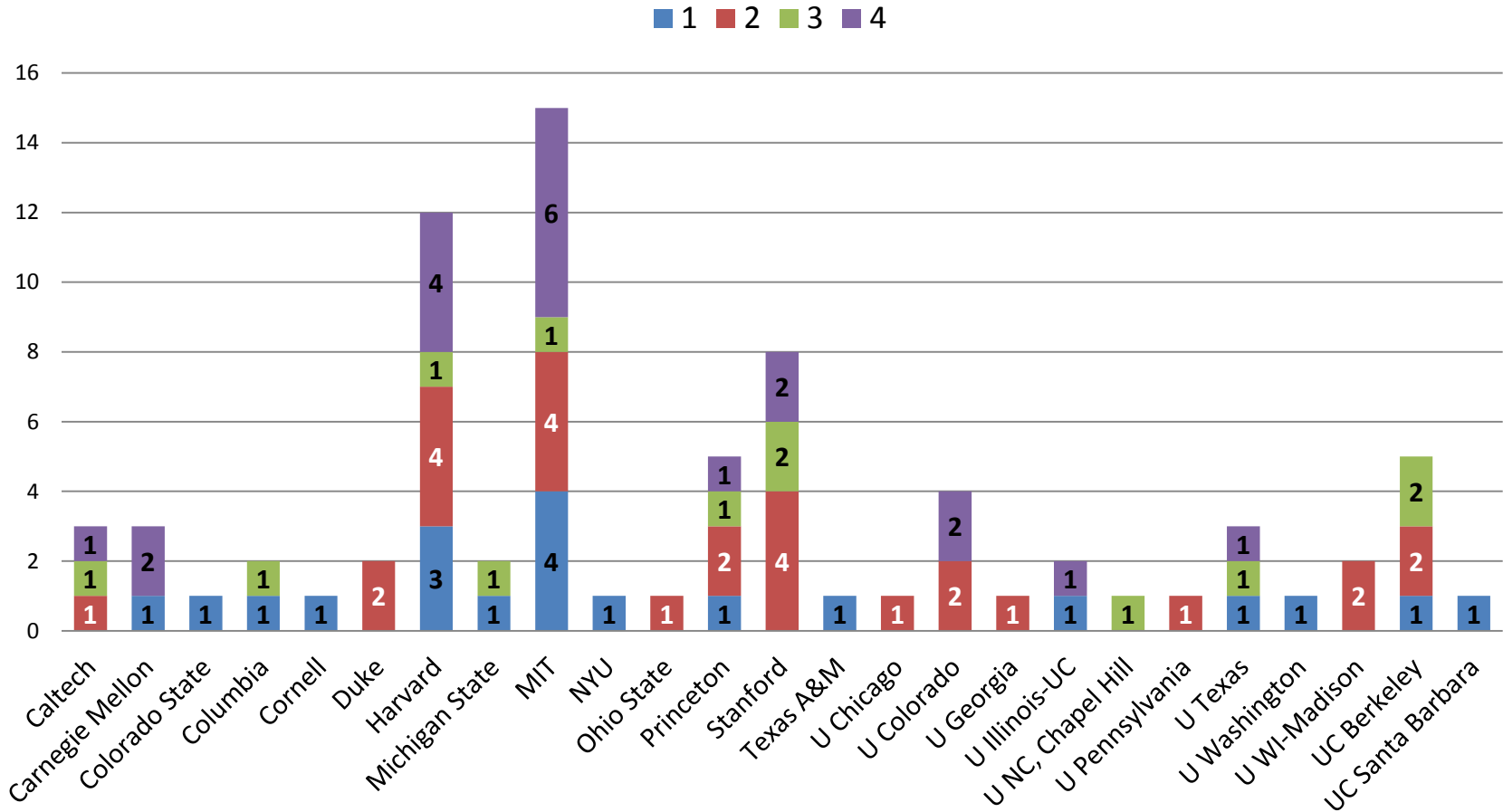

Alumni: Where are they now?

We have current employment data for 360 alumni grouped as follows:

- Industry 136
- Academia 108
- DOE Labs 54
- Other Gov't. 25
- Grad. Student 20
- Non-profit 13
- Other 4
- [Unknown 12]
- [Deceased 5]

Alumni by Category

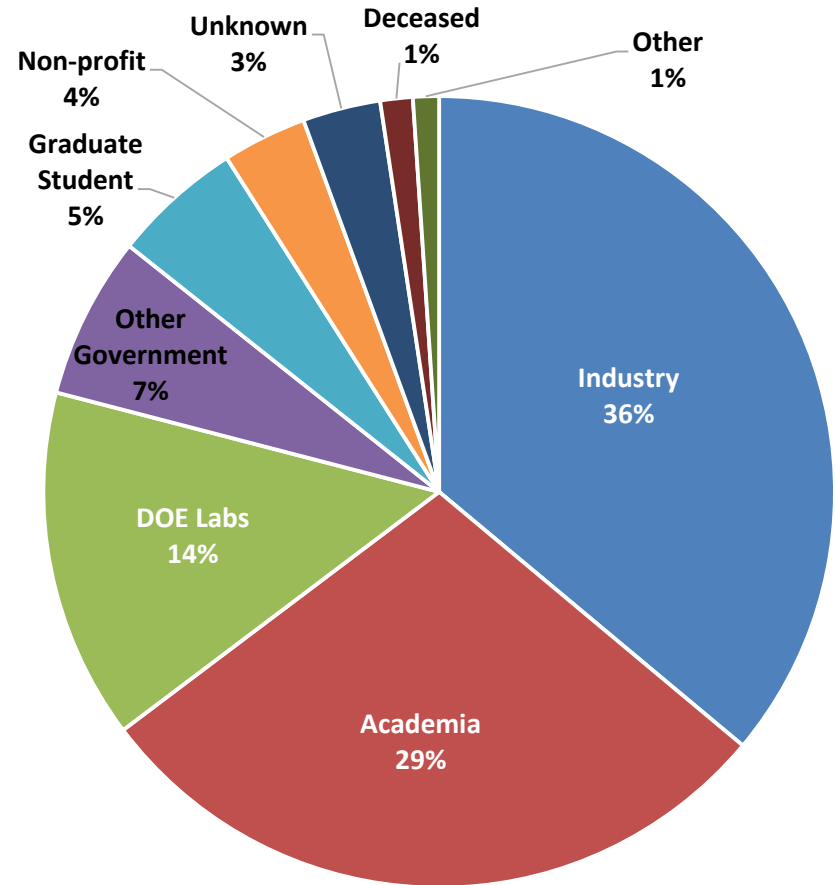

Current, primary employment category as of 3/20/2018.
 Total alumni number 377.
 Information is self-reported/-categorized by alumni.

Thirteen companies employ 27 percent of the 136 alumni in industry:

- Boston Consulting Group (2)
- Cascade Technologies, Inc. (2)
- GE/GE Hitachi (2)
- Goldman Sachs (3)
- Google/Google Research (7)
- GSK (2)
- Hudson River Trading (2)
- IBM (2)
- Intel Corporation (6)
- Lockheed Martin (2)
- Microsoft (3)
- Northrop Grumman Corporation (2)
- Siemens [formerly CD-adapco] (2)





*Current as of 3/19/2018.
Information is self-reported by alumni.*

ASCR Staffing Changes

- **Dave Goodwin Retired December 2017**
- **Robinson Pino is currently the Acting Director for the Research Division**
- **Benjamin Brown is currently the Acting Director for the Facilities Division**

- **SC Approved Backfills**
 - NERSC Program Manager – will be posted soon
 - Applied Math Program Manager – awaiting S-1 approval

SIAM recognizes ASCR leaders for exemplary research & outstanding service

	2018 SIAM Fellow	Contributions
	Alex Pothen Purdue University	Combinatorial algorithms for scientific applications, & leadership in founding the combinatorial scientific computing community.
	John N. Shadid Sandia National Laboratories & University of New Mexico	Solution methods for multi-physics systems, scalable parallel numerical algorithms, & numerical methods for strongly coupled nonlinear partial differential equations.
	Panayot S. Vassilevski Lawrence Livermore National Laboratory	Designing algebraic approaches for creating & analyzing multi-level algorithms.
	Karen E. Willcox Massachusetts Institute of Technology	Model reduction & multi-fidelity methods, with applications in optimization, control, design, & uncertainty quantification of large-scale systems.
	Homer F. Walker Worcester Polytechnic Institute	Theory and software of iterative methods for nonlinear systems & optimization, as well as applications of these methods to scientific simulations.



Town of Brookhaven Women's Recognition Award for Science

Kerstin Kleese van Dam Receives 32nd Town of Brookhaven Annual Women's Recognition Award for Science

Kleese van Dam is being recognized for her contributions to scientific computing and data management over the past three decades. Since being named director of CSI in 2015, she has continued to build a comprehensive research program in data-driven discovery at Brookhaven Lab. The nearly 90 staff members under her leadership are tackling the challenges that come with capturing, storing, analyzing, and distributing the large, complex volumes of data that scientists are generating at faster rates than ever before.



CRA Distinguished Service Award

Paul Messina has been selected as the 2018 recipient of the **CRA Distinguished Service Award** for his significant contributions to the advancement of high performance computing and decades of service to the field. Messina has an incredible record of building and managing large-scale, diverse research activities. Over the course of his career, he has designed, directed, and otherwise executed numerous initiatives that have influenced U.S. policy and programs resulting in the U.S. leadership position in high-performance computing.



Some ASCAC Agenda Details

- **UPDATE ON THE EXASCALE COMPUTING PROJECT** – *John Sarrao, LANL*
- **UPDATE ON CURRENT CHARGES**
 - *Program Response to Committee of visitors recommendations – Steve Lee, ASCR*
 - *ASCR Impacts – Paul Messina, ANL*
- **Workshop updates**
 - *Extreme Heterogeneity – Lucy Nowell, ASCR*
 - *Scientific Machine Learning – Steve Lee, ASCR*
- **PERSPECTIVE ON QUANTUM INFORMATION SYSTEM** – *Joe Lykken, Fermi National Accelerator Laboratory*
- **HPC IN CHINA** – *David Kahaner, Asian Technology Information Program*
- **EARLY CAREER: HYBRID METHODS FOR COLLISIONAL PARTICLE SYSTEMS** -- *Cory Hauck, Oak Ridge National Laboratory*
- **FUTURE LAB COMPUTING WORKING GROUP UPDATE:** *Rich Carlson, ASCR*